

OMRON

Open Network for High-Speed Control

CompoNet

Fast and Intelligent

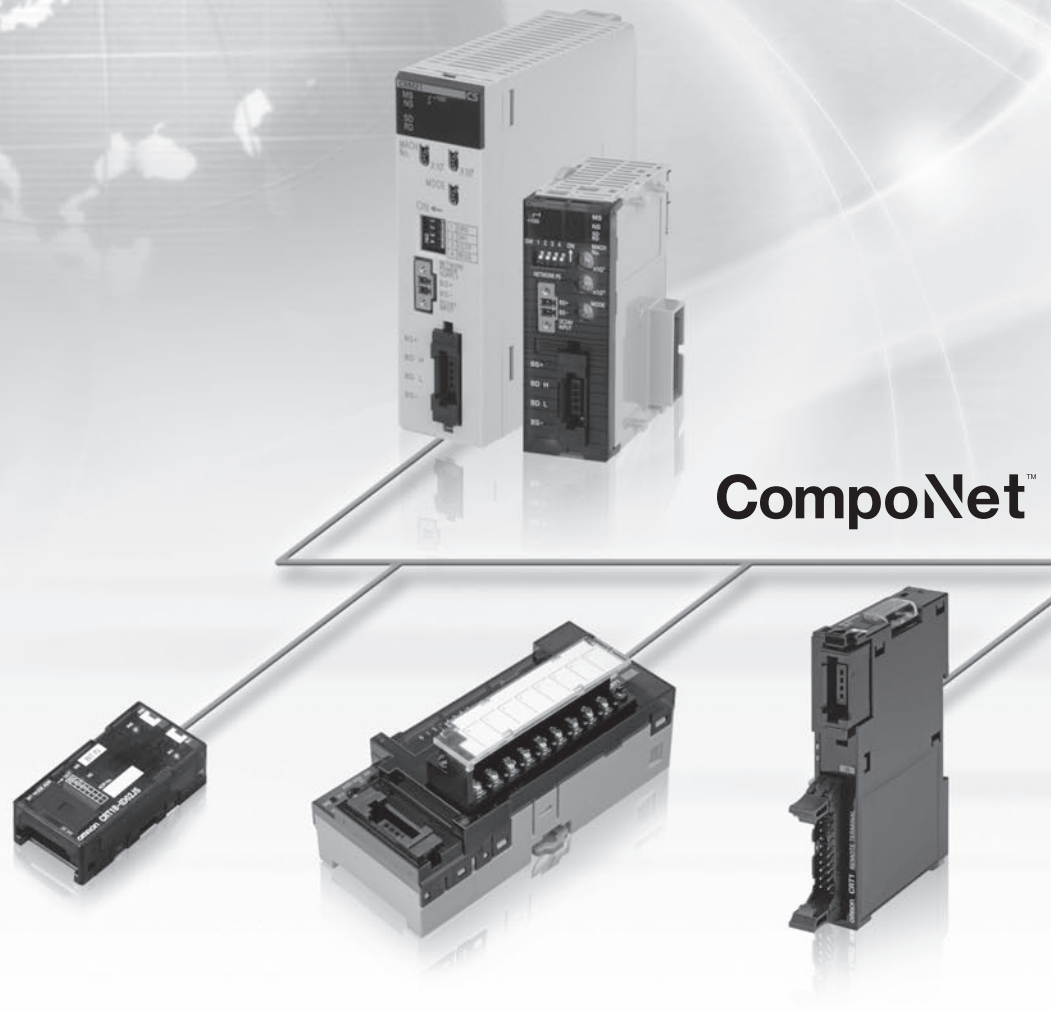

CompoNet™

realizing

Communications Specifications

| Item | Specification |
|--|---|
| Communications protocol | CompoNet Network protocol |
| Types of communications | Remote I/O communications (programless, constant sharing of data with Slave Units) and message communications (explicit message communications as required with Slave Units and FINS message communications as required with controllers) *1 |
| Baud rate | 4 Mbps *2, 3 Mbps, 1.5 Mbps, 93.75 kbps |
| Modulation | Base-band |
| Coding | Manchester code |
| Error control | Manchester code rules, CRC |
| Communications media *3 | The following media can be used. <ul style="list-style-type: none"> • Round cable I 2-wire 0.75 mm² • Round cable II 4-wire 0.75 mm² • Flat Cable I |
| Communications distance and wiring | Refer to <i>Cable Types, Baud Rates, and Maximum Distances</i> in the <i>Master Unit Operation Manual</i> . |
| Connectable Master Units | CompoNet Master Units |
| Connectable Slave Units | CompoNet Slave Units |
| Maximum I/O capacity | Word Slave Units: 1,024 inputs and 1,024 outputs (2,048 I/O points total) Bit Slave Units: 256 inputs and 256 outputs (512 I/O points total) |
| Maximum number of nodes | Word Slave Units: 64 input nodes and 64 output nodes Bit Slave Units: 128 input nodes and 128 output nodes Repeater Units: 64 nodes |
| Bits allocated per node address | Word Slave Units: 16 bits Bit Slave Units: 2 bits |
| Maximum number of nodes per trunk line or sub-trunk line | 32 nodes (Slave Units and Repeater Units) |
| Applicable node addresses | Word Slave Units: IN0 to IN63 and OUT0 to OUT63 Bit Slave Units: IN0 to IN127 and OUT0 to OUT127 Repeater Units: 0 to 63 |
| Repeater Unit application conditions | Up to 64 Repeater Units can be connected per network (i.e., per Master Unit). Up to 32 Repeater Units can be connected per trunk line or per sub-trunk line. When Repeater Units are connected in series from the Master Unit, up to two extra segment layers can be created (i.e., up to 2 Repeater Units are allowed between a Slave Unit and the Master Unit). |
| Signal lines | Two lines: BDH (communications data high) and BDL (communications data low) |
| Power lines | Two lines: BS+ and BS- (power for communications and internal Slave Unit circuits) <ul style="list-style-type: none"> • Power is supplied from the Master Unit or Repeater Units. |
| Communications power supply voltage | 24 VDC ±10% |
| Connection forms | Round cable II (4-wire) or Flat cable I at baud rate of 93.75 kbits/s: No restrictions Other cables or baud rates: Trunk line and branch lines Connections for Slave Units and Repeater Units: T-branch or multidrop connections |

*1 FINS message communications are supported by CJ-series Controllers only.

*2 A baud rate of 4 Mbps is not supported for branch lines and thus cannot be used for Slave Units with Cables (i.e., Bit Slave Units).

*3 Round cable I, round cable II and Flat Cable I are all different types of cable. To use more than one type of cable at a time, Repeater Units must be used to separate them on trunk lines and sub-trunk lines.

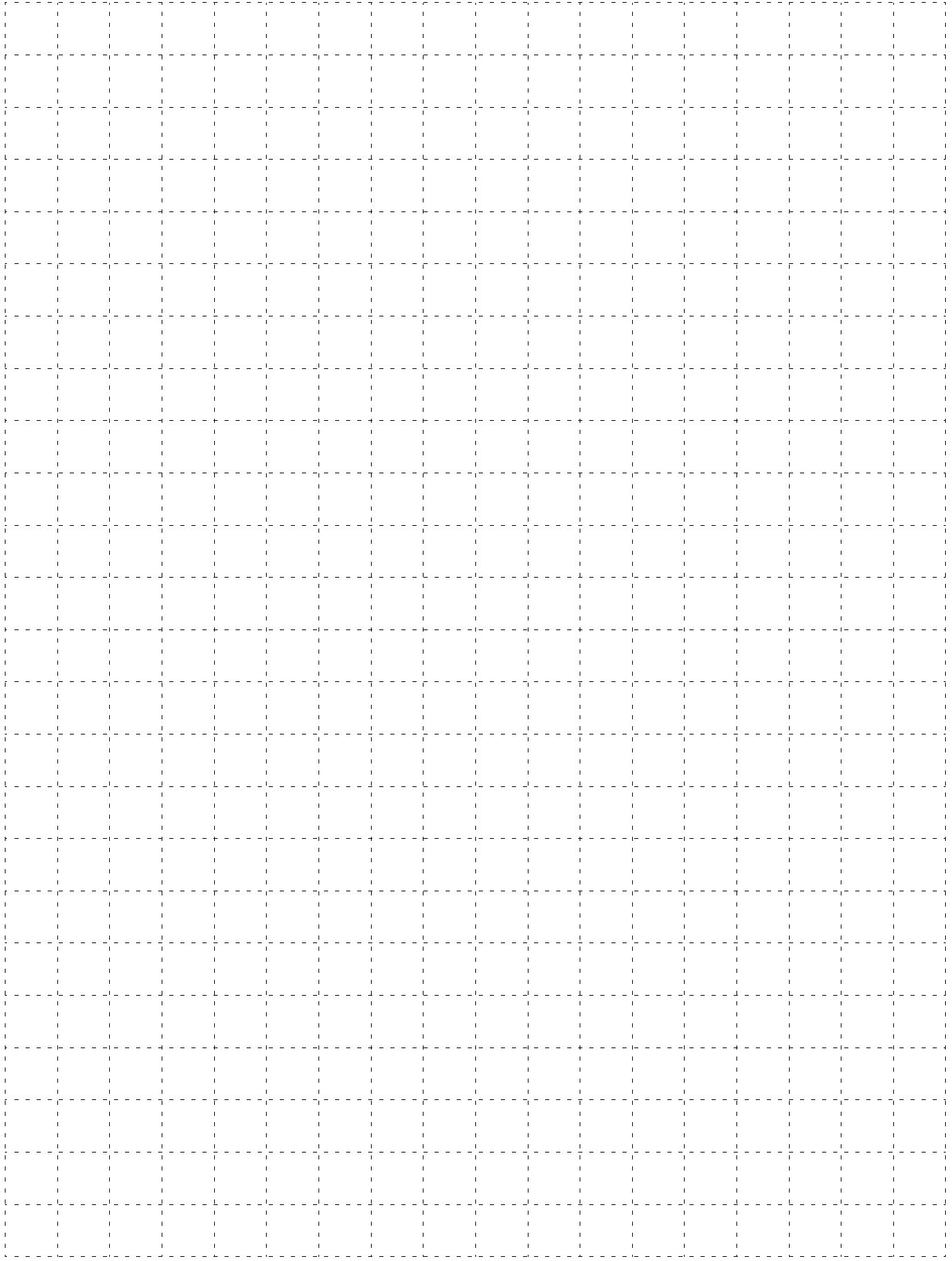

CompoNet Master Units

| | |
|--|---|
| CJ-series CompoNet Master Units..... | 5 |
| ■CJ1W-CRM21 | |
| CS-series CompoNet Master Units | 6 |
| ■CS1W-CRM21 | |
| CompoNet Master Board for PCI Bus/CompactPCI Bus | 7 |
| ■3G8F7-CRM21 | |

CJ/CS-series Master Unit Specifications

| Item | Model | CJ1W-CRM21 | CS1W-CRM21 |
|--|-------|--|--|
| Applicable Controller | | NJ *1 / CJ-series | CS-series |
| Unit classification | | CJ-series Special I/O Unit | CS-series Special I/O Unit |
| Current consumption (Power supplied from Power Supply Unit) | | 400 mA max. at 5 VDC | |
| Communications power supply connector | | One connector for the communications power supply is required for a Slave or Repeater Unit on the trunk line when using Round Cable II or Flat Cable I. *2 | |
| Communications power supply connector allowable current capacity | | 5 A max. (4 A max. for UL rating) When UL standards are being applied to your equipment, be sure the maximum allowable current is 4 A. | |
| Maximum number of mountable Master Units | | One word number assigned: 40 Units Two word numbers assigned: 40 Units Four word numbers assigned: 24 Units Eight word numbers assigned: 12 Units | One word number assigned: 80 Units Two word numbers assigned: 48 Units Four word numbers assigned: 24 Units Eight word numbers assigned: 12 Units |
| Mounting location | | According to NJ/CJ/CS-series Special I/O Unit specifications. | |
| Communications power ON/OFF monitoring | | The ON/OFF status of the communications power supply can be detected at the communications power supply connector. | |
| Data stored in Master Unit (built-in EEPROM) | | 1) The following device parameters: <ul style="list-style-type: none"> • Registration Table • Registration Table Check Type • Registered Slave Unit Participation Monitoring Time, Registered Slave Unit Participation Standby Mode, and Event Disable Setting • Software Settings Table • Manual I/O Communications Start Mode • Communications Error Input Data Zero Clear Mode • Network settings 2) Part of error history (depends on type of error; mainly serious error related to communications stopping) | |
| Noise immunity | | Conforms to IEC 61000-4-4 2 kV (applied to power supply). | |
| Vibration resistance | | 10 to 61.2 Hz with single-amplitude of 0.1 mm, 61.2 to 150 Hz and 14.7 m/s ² in X, Y, and Z directions for 80 min each (sweep time of 8 min × 10 sweeps = 80 min) | |
| Shock resistance | | 196 m/s ² (3 times each in X, Y, and Z directions) | |
| Dielectric strength | | 500 VAC (between isolated circuits) | |
| Insulation resistance | | 20 MΩ min. (between isolated circuits) | |
| Ambient operating temperature | | 0 to 55°C | |
| Ambient operating humidity | | 10 to 90% (no condensation) | |
| Ambient operating atmosphere | | No corrosive gases | |
| Storage temperature | | -20 to 75°C | |
| Weight | | 130 g max. (Master Unit only) | 190 g max. (Master Unit only) |

*1 Supported only CPU Units with unit version 1.01 or later and the Sysmac Studio version 1.02 or higher.

*2 Communications power does not need to be supplied to the Master Unit.

CJ-series CompoNet Master Units

CJ1W-CRM21

NJ/CJ-series CompoNet Master Units Increase the Range of Applicability of Sensors and Actuators.

The NJ/CJ-series CompoNet Master Unit manages the CompoNet network, controls communications between the Controller and Slave Units, and handles I/O data and message data.

- Setup is simple. Make the master's mode settings and set the baud rate, and you're ready to go.
- Control up to 2,560 I/O points and 384 nodes with one Master Unit.
- Intuitive memory mapping with separate areas for Word Slave Units and Bit Slave Units.
- Seven-segment display helps with startup and enables prompt detection of problems.
- Collect information from Slave Units using message communications, or use message communications to set parameters.
- Inherits the ease of use of the CompoBus/S.
- Flexible I/O allocations with software setting function.



Ordering Information

| Name | Specifications | | Number of unit numbers allocated | Power consumption (A) | | | Model |
|------------------------|---|---|----------------------------------|-----------------------|-------------|-------------|------------|
| | Types of communications | Maximum number of I/O points per Master Unit | | 5-V system | 24-V system | 26-V system | |
| CJ1 Special I/O Unit * | <ul style="list-style-type: none"> • Remote I/O communications • Message communications | Word Slave Units: 1,024 inputs and 1,024 outputs (2,048 I/O points total) Bit Slave Units: 256 inputs and 256 outputs (512 I/O points total) | 1, 2, 4, or 8 | 0.4 | --- | | CJ1W-CRM21 |

* These Units are also available with a DCN-TB4 Terminal Conversion Adapter included in the package. Add "(-B)" to the end of the model number to receive the Adapter as well.

Dimensions

(Unit: mm)

CJ1W-CRM21

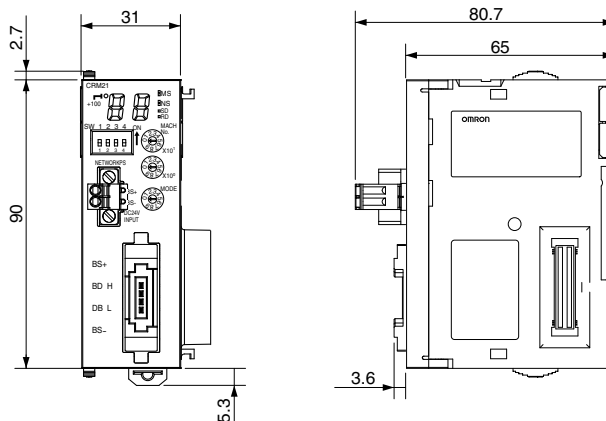

CS-series CompoNet Master Units

CS1W-CRM21

CS-series CompoNet Master Units Increase the Range of Applicability of Sensors and Actuators.

The CS-series CompoNet Master Unit manages the CompoNet network, controls communications between the PLC and Slave Units, and handles I/O data and message data.

- Setup is simple. Make the master's mode settings and set the baud rate, and you're ready to go.
- Control up to 2,560 I/O points and 384 nodes with one Master Unit.
- Intuitive memory mapping with separate areas for Word Slave Units and Bit Slave Units.
- Seven-segment display helps with startup and enables prompt detection of problems.
- Collect information from Slave Units using message communications, or use message communications to set parameters.
- Inherits the ease of use of the CompoBus/S.
- Flexible I/O allocations with software setting function.



Ordering Information

| Name | Specifications | | Number of unit numbers allocated | Power consumption (A) | | | Model |
|------------------------|---|---|----------------------------------|-----------------------|-------------|-------------|------------|
| | Types of communications | Maximum number of I/O points per Master Unit | | 5-V system | 24-V system | 26-V system | |
| CS1 Special I/O Unit * | <ul style="list-style-type: none"> • Remote I/O communications • Message communications | Word Slave Units: 1,024 inputs and 1,024 outputs (2,048 I/O points total) Bit Slave Units: 256 inputs and 256 outputs (512 I/O points total) | 1, 2, 4, or 8 | 0.4 | / | --- | CS1W-CRM21 |

* These Units are also available with a DCN-TB4 Terminal Conversion Adapter included in the package. Add "(-B)" to the end of the model number to receive the Adapter as well.

Dimensions

(Unit: mm)

CS1W-CRM21

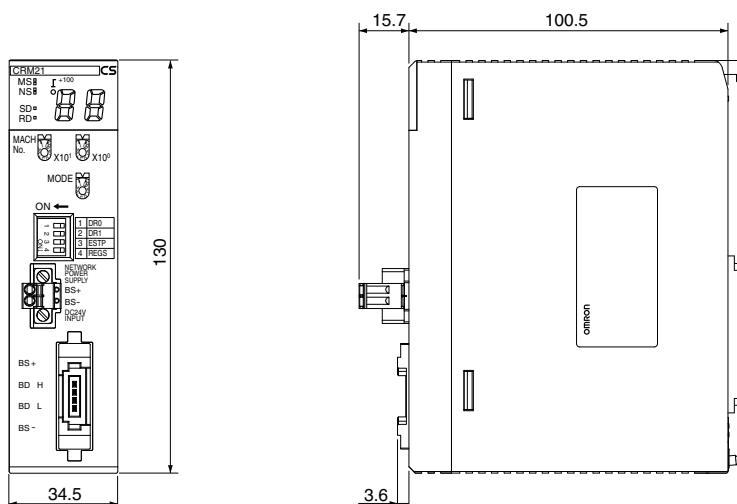

CompoNet Master Board for PCI Bus/CompactPCI Bus

3G8F7-CRM21

CompoNet Master Board for PC which provides ultra-high speed control

- Windows-base environment. Compatible with other OS, too when shared memory area is used.
- Combine PC with High-speed communication network "CompoNet" to achieve further fast communications.
- Familiar C/C++/VB based programming.



Ordering Information

| Name | Specification | Model |
|-----------------------------------|-------------------|-------------|
| CompoNet Master Board for PCI Bus | PCI bus Rev2.2 5V | 3G8F7-CRM21 |

General Specifications

| Item | Specifications |
|-------------------------------|---|
| | 3G8F7-CRM21 (PCI) |
| Bus specification | PCI bus Rev2.2 5 V |
| Number of mountable boards | 4 pieces |
| Compatible OS | Microsoft Windows 2000 / XP (32 Bit version) / Vista (32 Bit version) / 7 (32 Bit version) Other OS can be used, when the shared memory interface is directly accessed. |
| Weight | 90 g max. |
| Operation voltage | Internal power supply: 5 VDC±5% 3.3 VDC is not used. |
| Consumption current | Internal power supply: 5 VDC and 1.5 A max Communications power supply: 24 VDC and 80 mA max |
| Vibration resistance | 10 to 57 Hz, Amplitude 0.075 mm, 57 to 150 Hz Acceleration 9.8 m/s ² , 80 min in each direction of X, Y and Z (8 min of each sweep time × 10 sweeps = total 80 min) |
| Shock resistance | 147 m/s ² , 3 times in each direction of X, Y and Z. |
| Ambient operating temperature | 0 to 55°C |
| Ambient operating humidity | 0% to 80% RH (with no condensation) |
| Ambient operating atmosphere | No corrosive gas |
| Storage temperature | -20 to +60°C |

Development Environment

- Microsoft Visual C++ (Ver 6.0 to Ver 2008)
- Microsoft Visual Basic (Ver 6.0)
- CodeGear C++Builder (Ver 5 to Ver 2009)

Precautions for Correct Use

When you use the Board in an OS other than Windows by directly accessing the shared memory interface, provide the development environment applicable for the OS.

Dimensions

(unit: mm)

3G8F7-CRM21 (PCI)

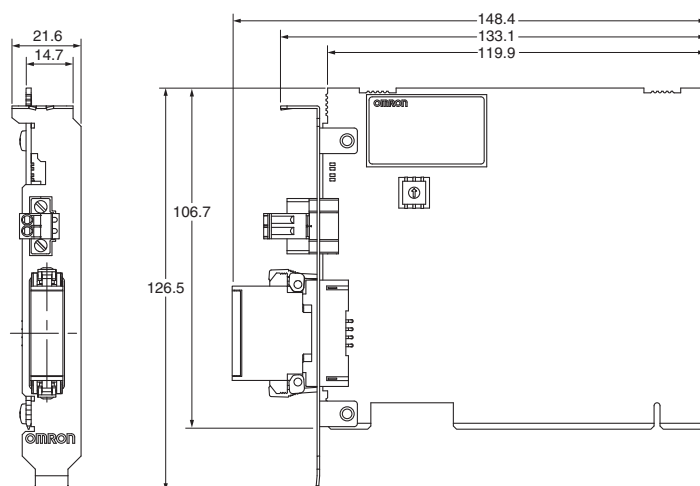

CompoNetGatewayUnit

| | |
|---|----|
| Overview of Gateway Unit..... | 10 |
| CompoNet Setting | 11 |
| CompoNet Gateway Unit for CC-Link | 12 |
| ■GQ-CRM21 | |

Overview of Gateway Unit

The CompoNet Gateway Unit works as a converter to connect CompoNet with another network with different protocol. The GQ-CRM21 CompoNet Gateway Unit for CC-Link provides one CC-Link port and one CompoNet port. It cyclically transfers I/O data between the CompoNet Slave Units and the CC-Link Master Unit.

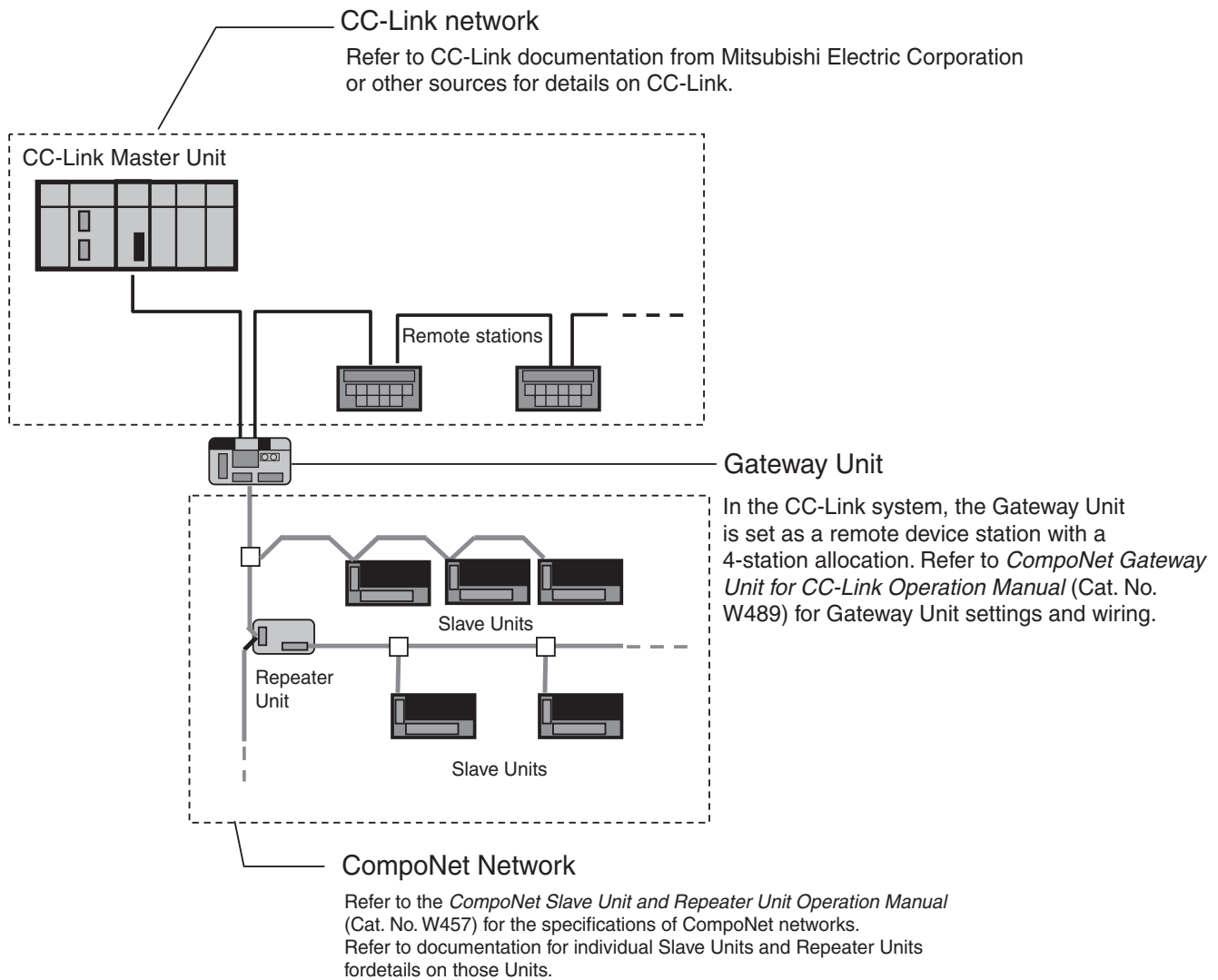

- “CC-Link” is a registered trademark of Mitsubishi Electric Corporation.
- “GX-Developer” is a registered trademark of Mitsubishi Electric Corporation.

CompoNet Setting

■ Setting the Communications Mode

To use the Gateway Unit, select the communications mode with the setting switches on the Gateway Unit. The below table lists the number of Slave Units (Word Slave Units and Bit Slave Units) and Control Points (the range of buffer memory allocated to the Gateway Unit in the CC-Link Master Unit) in each communications mode. (Refer to *CompoNet Gateway Unit for CC-Link Operation Manual* (Cat. No. W489) for details.)

The expanded cyclic setting (a network parameter set with the GX-Developer) in the CC-Link station information must be changed according to the communications mode.

| Mode number | Name | Connectable node addresses | Number of connected nodes | Control Points | CC-Link version and expanded cyclic setting |
|-------------|-----------------------|---|---|---|---|
| 0 | Communications mode 0 | Word Slave Unit: IN 0 to IN 63 and OUT 0 to OUT 63 Bit Slave Unit: IN 0 to IN 127 and OUT 0 to OUT 127 | Word Slave Unit IN 64/OUT 64 Bit Slave Unit IN 128/OUT 128 | Word Slave Unit: 1,024 inputs and 1,024 outputs Bit Slave Unit: 256 inputs and 256 outputs | Version 2, octuple (default) |
| 1 | Communications mode 1 | Word Slave Unit: IN 0 to IN 31 and OUT 0 to OUT 31 Bit Slave Unit: IN 0 to IN 95 and OUT 0 to OUT 95 | Word Slave Unit IN 32/OUT 32 Bit Slave Unit IN 96/OUT 96 | Word Slave Unit: 512 inputs and 512 outputs Bit Slave Unit: 192 inputs and 192 outputs | Version 2, quadruple |
| 2 | Communications mode 2 | Word Slave Unit: IN 0 to IN 15 and OUT 0 to OUT 15 Bit Slave Unit: IN 0 to IN 47 and OUT 0 to OUT 47 | Word Slave Unit IN 16/OUT 16 Bit Slave Unit IN 48/OUT 48 | Word Slave Unit: 256 inputs and 256 outputs Bit Slave Unit: 96 inputs and 96 outputs | Version 2, double |
| 3 | Communications mode 3 | Word Slave Unit: IN 0 to IN 7 and OUT 0 to OUT 7 Bit Slave Unit: IN 0 to IN 15 and OUT 0 to OUT 15 | Word Slave Unit IN 8/OUT 8 Bit Slave Unit IN 16/OUT 16 | Word Slave Unit: 128 inputs and 128 outputs Bit Slave Unit: 32 inputs and 32 outputs | Version 1 |
| 4 | Communications mode 4 | Word Slave Unit: IN 0 to IN 63 and OUT 0 to OUT 63 Bit Slave Unit: IN 0 to IN 127 and OUT 0 to OUT 127 | Word Slave Unit IN 64/OUT 64 Bit Slave Unit IN 128/OUT 128 | Word Slave Unit: 1,024 inputs and 1,024 outputs Bit Slave Unit: 256 inputs and 256 outputs | Version 2, quadruple |
| 5 | Communications mode 5 | Word Slave Unit: IN 0 to IN 31 and OUT 0 to OUT 31 Bit Slave Unit: IN 0 to IN 95 and OUT 0 to OUT 95 | Word Slave Unit IN 32/OUT 32 Bit Slave Unit IN 96/OUT 96 | Word Slave Unit: 512 inputs and 512 outputs Bit Slave Unit: 192 inputs and 192 outputs | Version 2, double |
| 6 | Communications mode 6 | Word Slave Unit: IN 0 to IN 15 and OUT 0 to OUT 15 Bit Slave Unit: IN 0 to IN 47 and OUT 0 to OUT 47 | Word Slave Unit IN 16/OUT 16 Bit Slave Unit IN 48/OUT 48 | Word Slave Unit: 256 inputs and 256 outputs Bit Slave Unit: 96 inputs and 96 outputs | Version 1 |
| 7 to 9 | Reserved | --- | --- | --- | --- |

CompoNet Gateway Unit for CC-Link

GQ-CRM21

"Easy" and "Flexible" system expansion with linked CC-Link and CompoNet.

- Branching is easily made with CompoNet. Wiring material cost can be reduced.
- Bit-level I/O distribution reduces wiring in the system.
- A wide variety of CompoNet Slave Units contribute to system size reduction.
- Seven-segment Display on the Gateway Unit helps to detect errors on site.
- The Participation Flags and Communications Error Flags can be checked at the Host Controller to detect the location and content of the error.



Ordering Information

| Name | Specifications | | | | | Model |
|-----------------------------------|--------------------------------------|-----------------------------|--|---------------------------------------|---|----------|
| | CC-Link Communications Specification | | | CompoNet Communications Specification | | |
| | Station Type | Number of stations occupied | CC-Link Version | Types of communications | Maximum I/O capacity | |
| CompoNet Gateway Unit for CC-Link | Remote device stations | 4 | Version 1.10 or 2.00 (Selected using mode switch.) | Remote I/O Communications | Word Slave Units: 2,048 I/O points total (1,024 inputs and 1,024 outputs) Bit Slave Units: 512 I/O points total (256 inputs and 256 outputs) | GQ-CRM21 |

Master Unit Specifications

| Item | Specification |
|-------------------------------|--|
| Unit power supply voltage | 21.6 to 26.4 VDC (24 VDC±10%) (Supplied from power supply connector.) |
| Current consumption | Communications power supply |
| | Internal current power consumption |
| Noise immunity | 3.80 A at 24 VDC |
| | 0.13 A at 24 VDC |
| Vibration resistance | Conforms to IEC 61000-4-4, 2.0 kV |
| Shock resistance | 10 to 60 Hz with 0.7-mm double amplitude, 60 to 150 Hz, 50 m/s ² for 80 min in X, Y, and Z directions |
| Dielectric strength | 150 m/s ² , 3 times in 6 directions on 3 axes |
| Installation method | 500 VAC |
| Ambient operating temperature | Mounted to DIN Track or by using M4 screws |
| Ambient operating humidity | 0 to 55 °C |
| Ambient storage temperature | 10% to 90% (with no condensation) |
| Weight | -25 to 65 °C |
| Ambient operating atmosphere | 110 g max. |
| | No corrosive gases |

Component Names and Functions

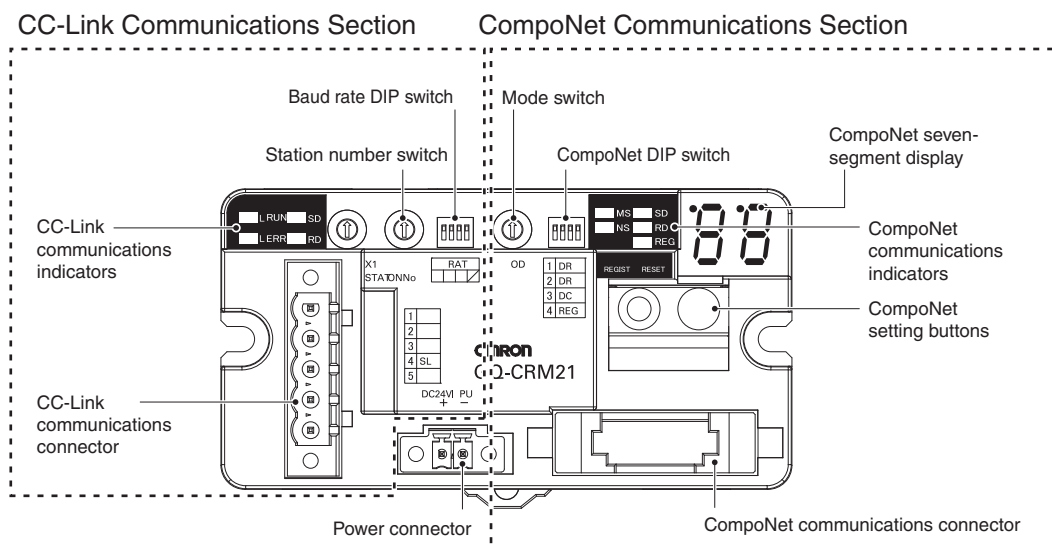

Dimensions

(Unit: mm)

GQ-CRM21

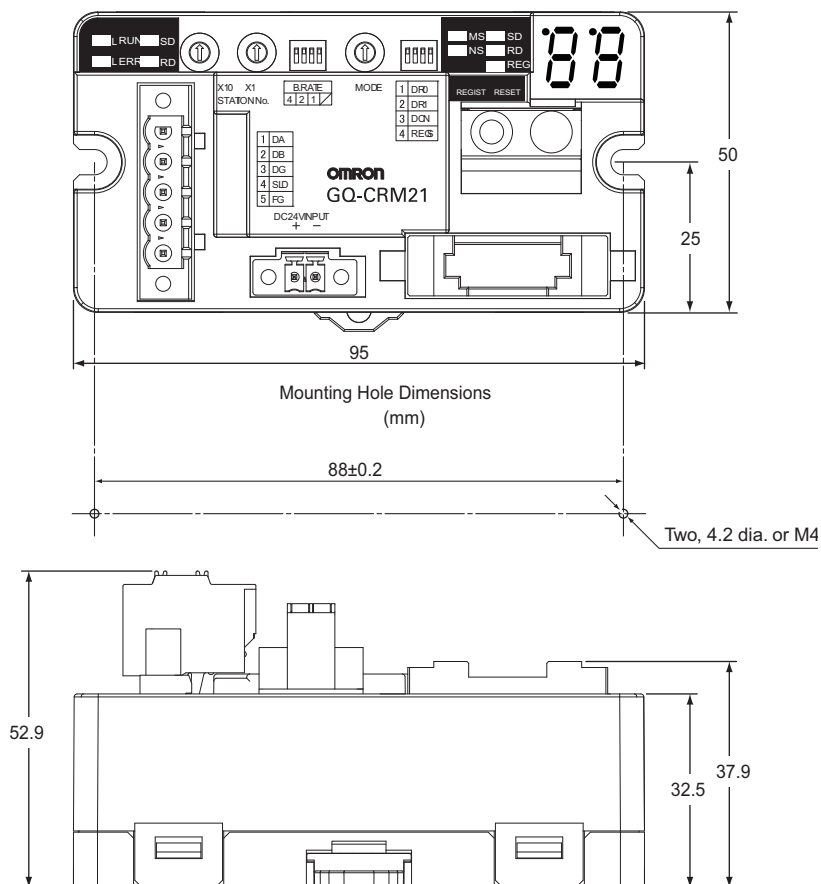

CC-Link Communications Specifications

| Item | Specification |
|---------------------------|--|
| Version | CC-Link version 1.10 or 2.00 (Selected using mode switch.) |
| Baud rate | 156 kbps, 625 kbps, 2.5 Mbps, 5 Mbps, or 10 Mbps |
| Communications method | Broadcast polling |
| Synchronization method | Frame synchronization |
| Encoding | NRZI |
| Transmission path | Bus (Conforms to RS-485.) |
| Transmission format | Conforms to HDLC. |
| Communications media | CC-Link cable (shielded, 3-core twisted-pair cable) |
| Number of connected nodes | Depends on specifications of the CC-Link master station. |
| Remote stations | 1 to 61 (Four station numbers are allocated starting from the specified station number.) |
| Error control | CRC ($X^{16} + X^{12} + X^5 + 1$) |
| RAS functions | Automatic recovery function, slave cutoff, data link status checks, offline testing |
| Allocated station numbers | Allocated four stations numbers as a remote device station |

CompoNet Slave Unit

| | |
|--|----|
| Smart Functions | 16 |
| What Are Smart Functions? | 27 |
| Basic Specification of Slave Units | 30 |
| Digital I/O Slave Units with Screw Terminal Blocks (2-tier Terminal Block/Relay Output/SSR Output) | 31 |
| ■ CRT1-□D08(-1)/□D16(-1)/ROS□/ROF□ | |
| Digital I/O Slave Units with Screw Terminal Blocks (3-tier Terminal Block) | 38 |
| ■ CRT1-□D08TA(-1)/□D16TA(-1)/□D08TAH(-1)/□D16TAH(-1) | |
| Digital I/O Slave Units with e-CON Connectors | 43 |
| ■ CRT1-□D16S(-1)/□D32S(-1)/□D16SH(-1)/□D32SH(-1) | |
| Digital I/O Slave Units with e-CON Connector (Vertical type) | 50 |
| ■ CRT1-VID08S(-1)/VOD08S(-1) | |
| Digital I/O Slave Units with MIL Connector (Vertical type) | 52 |
| ■ CRT1-VID16ML(-1)/VOD16ML(-1) | |
| Digital I/O Slave Units with MIL Connector (Vertical type) | 54 |
| ■ CRT1-VID32ML(-1)/VOD32ML(-1)/VMD32ML(-1) | |
| Digital I/O Slaves Units with Clamp Terminals | 57 |
| ■ CRT1-□D08SL(-1)/□D16SL(-1) | |
| Analog I/O Slave Units | 61 |
| ■ CRT1-AD04/DA02 | |
| Analog I/O Slave Units with MIL Connectors/e-CON Connectors | 63 |
| ■ CRT1-VAD04□□/-VDA02□□ | |
| Temperature Input Units | 67 |
| ■ CRT1-TS04T/-TS04P | |
| Expansion Units | 70 |
| ■ XWT-VOD08S(-1)/VMD08S(-1)/VOD16ML(-1)/VMD16ML(-1) | |
| SmartSlice GRT1-series | 72 |
| ■ GRT1-CRT | |
| ■ Slice I/O Units | |
| Bit Slave Units with Compact Connectors | 76 |
| ■ CRT1B-□D02JS(-1)/□D04JS(-1) | |
| Bit Slave Units with e-CON Connectors | 84 |
| ■ CRT1B-□D02S(-1) | |
| Repeater Unit | 88 |
| ■ CRS1-RPT01 | |
| Sensor Communication Unit (CompoNet) | 91 |
| ■ E3X-CRT | |
| Multi-function Compact Inverter MX2-Series V1 type CompoNet Communication Unit | 93 |
| ■ 3G3AX-MX2-CRT-E | |
| High-function General-purpose Inverter RX-Series V1 type CompoNet Communication Unit | 94 |
| ■ 3G3AX-RX-CRT-E | |

Smart Functions

The Slave Units provide Smart Functions that powerfully aid in everything from building the system and initial system startup to preventive system maintenance. The Smart Functions include functions for monitoring the operation time, changes in operating values, and other values, as well as functions that provide warnings for maintenance based on ON/OFF counts, total operating time, and other counted values.

■ CompoNet Slave Unit Functions

Yes: Supported, ---: Not supported

| Function | Unit | Digital I/O Slave Units | | | | |
|---|------|-------------------------|--------------|---------------|--------------|-----------|
| | | 2-tier Terminal block | | | | |
| | | CRT1-□D08(-1) | | CRT1-□D16(-1) | | |
| | | Input Units | Output Units | Input Units | Output Units | I/O Units |
| Operation Time Monitor | | | | Yes | | |
| Contact Operation Monitor* | | | | Yes | | |
| Total ON Time Monitor* | | | | Yes | | |
| Automatic Baud Rate Detection | | | | Yes | | |
| Unit Conduction Time Monitor | | | | Yes | | |
| Naming Units | | | | Yes | | |
| Naming Connected Devices | | | | Yes | | |
| Network Power Voltage Monitor | | | | Yes | | |
| I/O Power Status Monitor | | | | Yes | | |
| Communications Error History Monitor | | | | Yes | | |
| Input Filter | | Yes | --- | Yes | --- | Yes |
| Communications Error Output | | --- | Yes | --- | Yes | Yes |
| Preventing Malfunctions Caused by Inrush Current at I/O Startup | | Yes | --- | Yes | --- | Yes |
| Power Short-circuit Detection | | | | --- | | |
| Unconnected Line Detection | | | | --- | | |
| Load Short-circuit Detection | | | | --- | | |
| Disconnected Line Detection | | | | --- | | |
| Removable Terminal Block Structure | | | | Yes | | |
| Expansion Using Expansion Units | | | --- | | Yes | --- |
| Scaling | | | | --- | | |
| Last Maintenance Date | | | | Yes | | |
| Cumulated Count | | | | --- | | |
| Moving Average | | | | --- | | |
| Setting the Number of AD Conversion Points | | | | --- | | |
| Rate of Change | | | | --- | | |
| Comparator | | | | --- | | |
| Peak/Bottom Hold | | | | --- | | |
| Top/Valley Hold | | | | --- | | |
| User Adjustment | | | | --- | | |
| Top/Valley Count | | | | --- | | |
| Temperature Range Total Time Count | | | | --- | | |
| Input Temperature Variation Detection | | | | --- | | |
| Input Error Detection Disable Function | | | | --- | | |

Reducing System Startup Time

- Network Power Voltage Monitor
- Input Filter
- Preventing Malfunctions Caused by Inrush Current at Startup
- Automatic Baud Rate Detection
- Scaling
- User Adjustment
- Cumulative Counter
- Moving Average
- Setting the Number of AD Conversion Point
- Peak/Bottom Hold
- Top/Valley Hold
- Rate of Change

Reducing Downtime

- Naming Units
- Naming Connected Devices
- I/O Power Status Monitor
- Power Short-circuit Detection
- Unconnected Line Detection
- Disconnected Line Detection

Improving Maintenance

- Operation Time Monitor
- Contact Operation Monitor
- Unit Conduction Time Monitor
- Total ON Time Monitor
- Network Power Voltage Monitor
- Communications Error History Monitor
- Last Maintenance Date
- Comparator
- Communications Error Output

* The Contact Operation Monitor and the Total ON Time Monitor cannot be used at the same time for the same contact.

Yes: Supported, ---: Not supported

| Function | Unit | | | |
|---|-------------------------|------------|--------------|------------|
| | Digital I/O Slave Units | | | |
| | 2-tier Terminal block | | | |
| | CRT1-ROS08 | CRT1-ROS16 | CRT1-ROF08 | CRT1-ROF16 |
| | Output Units | | Output Units | |
| Operation Time Monitor | Yes | | Yes | |
| Contact Operation Monitor* | Yes | | Yes | |
| Total ON Time Monitor* | Yes | | Yes | |
| Automatic Baud Rate Detection | Yes | | Yes | |
| Unit Conduction Time Monitor | Yes | | Yes | |
| Naming Units | Yes | | Yes | |
| Naming Connected Devices | Yes | | Yes | |
| Network Power Voltage Monitor | Yes | | Yes | |
| I/O Power Status Monitor | --- | | --- | |
| Communications Error History Monitor | Yes | | Yes | |
| Input Filter | --- | | --- | |
| Communications Error Output | Yes | | Yes | |
| Preventing Malfunctions Caused by Inrush Current at I/O Startup | --- | | --- | |
| Power Short-circuit Detection | --- | | --- | |
| Unconnected Line Detection | --- | | --- | |
| Load Short-circuit Detection | --- | | --- | |
| Disconnected Line Detection | --- | | --- | |
| Removable Terminal Block Structure | Yes | | Yes | |
| Expansion Using Expansion Units | --- | Yes | --- | Yes |
| Scaling | --- | | --- | |
| Last Maintenance Date | Yes | | Yes | |
| Cumulated Count | --- | | --- | |
| Moving Average | --- | | --- | |
| Setting the Number of AD Conversion Points | --- | | --- | |
| Rate of Change | --- | | --- | |
| Comparator | --- | | --- | |
| Peak/Bottom Hold | --- | | --- | |
| Top/Valley Hold | --- | | --- | |
| User Adjustment | --- | | --- | |
| Top/Valley Count | --- | | --- | |
| Temperature Range Total Time Count | --- | | --- | |
| Input Temperature Variation Detection | --- | | --- | |
| Input Error Detection Disable Function | --- | | --- | |

* The Contact Operation Monitor and the Total ON Time Monitor cannot be used at the same time for the same contact.

Yes: Supported, ---: Not supported

| Function | Unit | | | |
|---|--|--------------|--|--------------|
| | Digital I/O Slave Units | | | |
| | 3-tier Terminal block | | | |
| | CRT1-□D08TA(-1) (without Short-circuit and Disconnected Line Detection) | | CRT1-□D08TAH(-1) (with Short-circuit and Disconnected Line Detection) | |
| | Input Units | Output Units | Input Units | Output Units |
| Operation Time Monitor | Yes | | | |
| Contact Operation Monitor* | Yes | | | |
| Total ON Time Monitor* | Yes | | | |
| Automatic Baud Rate Detection | Yes | | | |
| Unit Conduction Time Monitor | Yes | | | |
| Naming Units | Yes | | | |
| Naming Connected Devices | Yes | | | |
| Network Power Voltage Monitor | Yes | | | |
| I/O Power Status Monitor | Yes | | | |
| Communications Error History Monitor | Yes | | | |
| Input Filter | Yes | --- | Yes | --- |
| Communications Error Output | --- | Yes | --- | Yes |
| Preventing Malfunctions Caused by Inrush Current at I/O Startup | Yes | --- | Yes | --- |
| Power Short-circuit Detection | --- | | Yes | --- |
| Unconnected Line Detection | --- | | Yes | --- |
| Load Short-circuit Detection | --- | | --- | Yes |
| Disconnected Line Detection | --- | | --- | Yes |
| Removable Terminal Block Structure | Yes | | | |
| Expansion Using Expansion Units | --- | | | |
| Scaling | --- | | | |
| Last Maintenance Date | Yes | | | |
| Cumulated Count | --- | | | |
| Moving Average | --- | | | |
| Setting the Number of AD Conversion Points | --- | | | |
| Rate of Change | --- | | | |
| Comparator | --- | | | |
| Peak/Bottom Hold | --- | | | |
| Top/Valley Hold | --- | | | |
| User Adjustment | --- | | | |
| Top/Valley Count | --- | | | |
| Temperature Range Total Time Count | --- | | | |
| Input Temperature Variation Detection | --- | | | |
| Input Error Detection Disable Function | --- | | | |

* The Contact Operation Monitor and the Total ON Time Monitor cannot be used at the same time for the same contact.

Yes: Supported, ---: Not supported

| Function | Digital I/O Slave Units | | | | | |
|---|--|--------------|-----------|--|--------------|-----------|
| | 3-tier Terminal block | | | | | |
| | CRT1-□D16TA(-1) (without Short-circuit and Disconnected Line Detection) | | | CRT1-□D16TAH(-1) (with Short-circuit and Disconnected Line Detection) | | |
| | Input Units | Output Units | I/O Units | Input Units | Output Units | I/O units |
| Operation Time Monitor | Yes | | | | | |
| Contact Operation Monitor* | Yes | | | | | |
| Total ON Time Monitor* | Yes | | | | | |
| Automatic Baud Rate Detection | Yes | | | | | |
| Unit Conduction Time Monitor | Yes | | | | | |
| Naming Units | Yes | | | | | |
| Naming Connected Devices | Yes | | | | | |
| Network Power Voltage Monitor | Yes | | | | | |
| I/O Power Status Monitor | Yes | | | | | |
| Communications Error History Monitor | Yes | | | | | |
| Input Filter | Yes | --- | Yes | Yes | --- | Yes |
| Communications Error Output | --- | Yes | Yes | --- | Yes | Yes |
| Preventing Malfunctions Caused by Inrush Current at I/O Startup | Yes | --- | Yes | Yes | --- | Yes |
| Power Short-circuit Detection | --- | | | Yes | --- | Yes |
| Unconnected Line Detection | --- | | | Yes | --- | Yes |
| Load Short-circuit Detection | --- | | | --- | Yes | Yes |
| Disconnected Line Detection | --- | | | --- | Yes | Yes |
| Removable Terminal Block Structure | Yes | | | | | |
| Expansion Using Expansion Units | --- | | | | | |
| Scaling | --- | | | | | |
| Last Maintenance Date | Yes | | | | | |
| Cumulated Count | --- | | | | | |
| Moving Average | --- | | | | | |
| Setting the Number of AD Conversion Points | --- | | | | | |
| Rate of Change | --- | | | | | |
| Comparator | --- | | | | | |
| Peak/Bottom Hold | --- | | | | | |
| Top/Valley Hold | --- | | | | | |
| User Adjustment | --- | | | | | |
| Top/Valley Count | --- | | | | | |
| Temperature Range Total Time Count | --- | | | | | |
| Input Temperature Variation Detection | --- | | | | | |
| Input Error Detection Disable Function | --- | | | | | |

* The Contact Operation Monitor and the Total ON Time Monitor cannot be used at the same time for the same contact.

Yes: Supported, ---: Not supported

| Function | Unit | Digital I/O Slave Units | |
|---|------|-----------------------------|--------------|
| | | Units with e-CON Connectors | |
| | | CRT1-V□D08S(-1) | |
| | | Input Units | Output Units |
| Operation Time Monitor | | Yes | |
| Contact Operation Monitor* | | Yes | |
| Total ON Time Monitor* | | Yes | |
| Automatic Baud Rate Detection | | Yes | |
| Unit Conduction Time Monitor | | Yes | |
| Naming Units | | Yes | |
| Naming Connected Devices | | Yes | |
| Network Power Voltage Monitor | | Yes | |
| I/O Power Status Monitor | | --- | Yes |
| Communications Error History Monitor | | Yes | |
| Input Filter | | Yes | --- |
| Communications Error Output | | --- | Yes |
| Preventing Malfunctions Caused by Inrush Current at I/O Startup | | Yes | --- |
| Power Short-circuit Detection | | --- | |
| Unconnected Line Detection | | --- | |
| Load Short-circuit Detection | | --- | |
| Disconnected Line Detection | | --- | |
| Removable Terminal Block Structure | | --- | |
| Expansion Using Expansion Units | | --- | |
| Scaling | | --- | |
| Last Maintenance Date | | Yes | |
| Cumulated Count | | --- | |
| Moving Average | | --- | |
| Setting the Number of AD Conversion Points | | --- | |
| Rate of Change | | --- | |
| Comparator | | --- | |
| Peak/Bottom Hold | | --- | |
| Top/Valley Hold | | --- | |
| User Adjustment | | --- | |
| Top/Valley Count | | --- | |
| Temperature Range Total Time Count | | --- | |
| Input Temperature Variation Detection | | --- | |
| Input Error Detection Disable Function | | --- | |

* The Contact Operation Monitor and the Total ON Time Monitor cannot be used at the same time for the same contact.

Yes: Supported, ---: Not supported

| Function | Digital I/O Slave Units | | | | | |
|---|---|--------------|-----------|---|--------------|-----------|
| | Units with e-CON Connectors | | | | | |
| | CRT1-□D16S(-1) (without Short-circuit and Disconnected Line Detection) | | | CRT1-□D16SH(-1) (with Short-circuit and Disconnected Line Detection) | | |
| | Input Units | Output Units | I/O Units | Input Units | Output Units | I/O units |
| Operation Time Monitor | Yes | | | | | |
| Contact Operation Monitor* | Yes | | | | | |
| Total ON Time Monitor* | Yes | | | | | |
| Automatic Baud Rate Detection | Yes | | | | | |
| Unit Conduction Time Monitor | Yes | | | | | |
| Naming Units | Yes | | | | | |
| Naming Connected Devices | Yes | | | | | |
| Network Power Voltage Monitor | Yes | | | | | |
| I/O Power Status Monitor | --- | Yes | Yes | --- | Yes | Yes |
| Communications Error History Monitor | Yes | | | | | |
| Input Filter | Yes | --- | Yes | Yes | --- | Yes |
| Communications Error Output | --- | Yes | Yes | --- | Yes | Yes |
| Preventing Malfunctions Caused by Inrush Current at I/O Startup | Yes | --- | Yes | Yes | --- | Yes |
| Power Short-circuit Detection | --- | | | Yes | --- | Yes |
| Unconnected Line Detection | --- | | | Yes | --- | Yes |
| Load Short-circuit Detection | --- | | | --- | Yes | Yes |
| Disconnected Line Detection | --- | | | --- | Yes | Yes |
| Removable Terminal Block Structure | --- | | | | | |
| Expansion Using Expansion Units | --- | | | | | |
| Scaling | --- | | | | | |
| Last Maintenance Date | Yes | | | | | |
| Cumulated Count | --- | | | | | |
| Moving Average | --- | | | | | |
| Setting the Number of AD Conversion Points | --- | | | | | |
| Rate of Change | --- | | | | | |
| Comparator | --- | | | | | |
| Peak/Bottom Hold | --- | | | | | |
| Top/Valley Hold | --- | | | | | |
| User Adjustment | --- | | | | | |
| Top/Valley Count | --- | | | | | |
| Temperature Range Total Time Count | --- | | | | | |
| Input Temperature Variation Detection | --- | | | | | |
| Input Error Detection Disable Function | --- | | | | | |

* The Contact Operation Monitor and the Total ON Time Monitor cannot be used at the same time for the same contact.

| Function | Digital I/O Slave Units | | | | | |
|---|---|--------------|-----------|---|--------------|-----------|
| | Units with e-CON Connectors | | | | | |
| | CRT1-□D32S(-1) (without Short-circuit and Disconnected Line Detection) | | | CRT1-□D32SH(-1) (with Short-circuit and Disconnected Line Detection) | | |
| | Input Units | Output Units | I/O Units | Input Units | Output Units | I/O units |
| Operation Time Monitor | Yes | | | | | |
| Contact Operation Monitor* | Yes | | | | | |
| Total ON Time Monitor* | Yes | | | | | |
| Automatic Baud Rate Detection | Yes | | | | | |
| Unit Conduction Time Monitor | Yes | | | | | |
| Naming Units | Yes | | | | | |
| Naming Connected Devices | Yes | | | | | |
| Network Power Voltage Monitor | Yes | | | | | |
| I/O Power Status Monitor | --- | Yes | Yes | --- | Yes | Yes |
| Communications Error History Monitor | Yes | | | | | |
| Input Filter | Yes | --- | Yes | Yes | --- | Yes |
| Communications Error Output | --- | Yes | Yes | --- | Yes | Yes |
| Preventing Malfunctions Caused by Inrush Current at I/O Startup | Yes | --- | Yes | Yes | --- | Yes |
| Power Short-circuit Detection | --- | | | Yes | --- | Yes |
| Unconnected Line Detection | --- | | | Yes | --- | Yes |
| Load Short-circuit Detection | --- | | | --- | Yes | Yes |
| Disconnected Line Detection | --- | | | --- | Yes | Yes |
| Removable Terminal Block Structure | --- | | | | | |
| Expansion Using Expansion Units | --- | | | | | |
| Scaling | --- | | | | | |
| Last Maintenance Date | Yes | | | | | |
| Cumulated Count | --- | | | | | |
| Moving Average | --- | | | | | |
| Setting the Number of AD Conversion Points | --- | | | | | |
| Rate of Change | --- | | | | | |
| Comparator | --- | | | | | |
| Peak/Bottom Hold | --- | | | | | |
| Top/Valley Hold | --- | | | | | |
| User Adjustment | --- | | | | | |
| Top/Valley Count | --- | | | | | |
| Temperature Range Total Time Count | --- | | | | | |
| Input Temperature Variation Detection | --- | | | | | |
| Input Error Detection Disable Function | --- | | | | | |

* The Contact Operation Monitor and the Total ON Time Monitor cannot be used at the same time for the same contact.

Yes: Supported, ---: Not supported

| Function | Digital I/O Slave Units | | | | |
|---|---------------------------|--------------|------------------|--------------|-----------|
| | Units with MIL Connectors | | | | |
| | CRT1-V□D16ML(-1) | | CRT1-V□D32ML(-1) | | |
| | Input Units | Output Units | Input Units | Output Units | I/O Units |
| Operation Time Monitor | Yes | | | | |
| Contact Operation Monitor* | Yes | | | | |
| Total ON Time Monitor* | Yes | | | | |
| Automatic Baud Rate Detection | Yes | | | | |
| Unit Conduction Time Monitor | Yes | | | | |
| Naming Units | Yes | | | | |
| Naming Connected Devices | Yes | | | | |
| Network Power Voltage Monitor | Yes | | | | |
| I/O Power Status Monitor | Yes | | | | |
| Communications Error History Monitor | Yes | | | | |
| Input Filter | Yes | --- | Yes | --- | Yes |
| Communications Error Output | --- | Yes | --- | Yes | Yes |
| Preventing Malfunctions Caused by Inrush Current at I/O Startup | Yes | --- | Yes | --- | Yes |
| Power Short-circuit Detection | --- | | | | |
| Unconnected Line Detection | --- | | | | |
| Load Short-circuit Detection | --- | | | | |
| Disconnected Line Detection | --- | | | | |
| Removable Terminal Block Structure | --- | | | | |
| Expansion Using Expansion Units | --- | | | | |
| Scaling | --- | | | | |
| Last Maintenance Date | Yes | | | | |
| Cumulated Count | --- | | | | |
| Moving Average | --- | | | | |
| Setting the Number of AD Conversion Points | --- | | | | |
| Rate of Change | --- | | | | |
| Comparator | --- | | | | |
| Peak/Bottom Hold | --- | | | | |
| Top/Valley Hold | --- | | | | |
| User Adjustment | --- | | | | |
| Top/Valley Count | --- | | | | |
| Temperature Range Total Time Count | --- | | | | |
| Input Temperature Variation Detection | --- | | | | |
| Input Error Detection Disable Function | --- | | | | |

* The Contact Operation Monitor and the Total ON Time Monitor cannot be used at the same time for the same contact.

Yes: Supported, ---: Not supported

| Function | Unit | Digital I/O Slave Units | | | | |
|---|------|---------------------------------------|--------------|-----------------|--------------|-----------|
| | | Units with Screw-less Clamp Terminals | | | | |
| | | CRT1-□D08SL(-1) | | CRT1-□D16SL(-1) | | |
| | | Input Units | Output Units | Input Units | Output Units | I/O Units |
| Operation Time Monitor | | Yes | | | | |
| Contact Operation Monitor* | | Yes | | | | |
| Total ON Time Monitor* | | Yes | | | | |
| Automatic Baud Rate Detection | | Yes | | | | |
| Unit Conduction Time Monitor | | Yes | | | | |
| Naming Units | | Yes | | | | |
| Naming Connected Devices | | Yes | | | | |
| Network Power Voltage Monitor | | Yes | | | | |
| I/O Power Status Monitor | | Yes | | | | |
| Communications Error History Monitor | | Yes | | | | |
| Input Filter | Yes | --- | Yes | --- | Yes | |
| Communications Error Output | --- | Yes | --- | Yes | Yes | |
| Preventing Malfunctions Caused by Inrush Current at I/O Startup | Yes | --- | Yes | --- | Yes | |
| Power Short-circuit Detection | | --- | | | | |
| Unconnected Line Detection | | --- | | | | |
| Load Short-circuit Detection | | --- | | | | |
| Disconnected Line Detection | | --- | | | | |
| Removable Terminal Block Structure | | Yes | | | | |
| Expansion Using Expansion Units | | --- | | | | |
| Scaling | | --- | | | | |
| Last Maintenance Date | | Yes | | | | |
| Cumulated Count | | --- | | | | |
| Moving Average | | --- | | | | |
| Setting the Number of AD Conversion Points | | --- | | | | |
| Rate of Change | | --- | | | | |
| Comparator | | --- | | | | |
| Peak/Bottom Hold | | --- | | | | |
| Top/Valley Hold | | --- | | | | |
| User Adjustment | | --- | | | | |
| Top/Valley Count | | --- | | | | |
| Temperature Range Total Time Count | | --- | | | | |
| Input Temperature Variation Detection | | --- | | | | |
| Input Error Detection Disable Function | | --- | | | | |

* The Contact Operation Monitor and the Total ON Time Monitor cannot be used at the same time for the same contact.

Yes: Supported, ---: Not supported

| Function | Unit | | | | | |
|---|----------------------------------|--------------|-----------------------------|--------------|------------------------------|--------------|
| | Analog I/O Slave Units | | | | | |
| | Units with 2-tier Terminal block | | Units with e-CON Connectors | | Units with MIL Connectors | |
| | CRT1-AD04 CRT1-DA02 | | CRT1-VAD04S CRT1-VDA02S | | CRT1-VAD04ML CRT1-VDA02ML | |
| | Input Units | Output Units | Input Units | Output Units | Input Units | Output Units |
| Operation Time Monitor | --- | | | | | |
| Contact Operation Monitor* | --- | | | | | |
| Total ON Time Monitor* | --- | | | | | |
| Automatic Baud Rate Detection | Yes | | | | | |
| Unit Conduction Time Monitor | Yes | | | | | |
| Naming Units | Yes | | | | | |
| Naming Connected Devices | Yes | | | | | |
| Network Power Voltage Monitor | Yes | | | | | |
| I/O Power Status Monitor | --- | | | | | |
| Communications Error History Monitor | Yes | | | | | |
| Input Filter | --- | | | | | |
| Communications Error Output | --- | Yes | --- | Yes | --- | Yes |
| Preventing Malfunctions Caused by Inrush Current at I/O Startup | --- | | | | | |
| Power Short-circuit Detection | --- | | | | | |
| Unconnected Line Detection | --- | | | | | |
| Load Short-circuit Detection | --- | | | | | |
| Disconnected Line Detection | Yes | --- | Yes | --- | Yes | --- |
| Removable Terminal Block Structure | Yes | | | | | |
| Expansion Using Expansion Units | --- | | | | | |
| Scaling | Yes | | | | | |
| Last Maintenance Date | Yes | | | | | |
| Cumulated Count | Yes | | | | | |
| Moving Average | Yes | --- | Yes | --- | Yes | --- |
| Setting the Number of AD Conversion Points | Yes | --- | Yes | --- | Yes | --- |
| Rate of Change | Yes | --- | Yes | --- | Yes | --- |
| Comparator | Yes | --- | Yes | --- | Yes | --- |
| Peak/Bottom Hold | Yes | --- | Yes | --- | Yes | --- |
| Top/Valley Hold | Yes | --- | Yes | --- | Yes | --- |
| User Adjustment | Yes | | | | | |
| Top/Valley Count | --- | | | | | |
| Temperature Range Total Time Count | --- | | | | | |
| Input Temperature Variation Detection | --- | | | | | |
| Input Error Detection Disable Function | --- | | | | | |

* The Contact Operation Monitor and the Total ON Time Monitor cannot be used at the same time for the same contact.

Yes: Supported, ---: Not supported

| Function | Unit | Bit Slave Units | | Bit Slaves with Compact Connectors | | | | | | Repeater Unit | Sensor Communication Unit |
|---|------------------------|-----------------|-------------|------------------------------------|-------------|--------------|------------------|-------------|--------------|---------------|---------------------------|
| | SmartSlice GRT1 Series | CRT1B-□D02S(-1) | | CRT1B-□D02JS(-1) | | | CRT1B-□D04JS(-1) | | | CRS1-RPT01 | E3X-CRT |
| | | GRT1-CRT | Input Units | Output Units | Input Units | Output Units | I/O units | Input Units | Output Units | | |
| Operation Time Monitor | --- | Yes | | --- | | | --- | | | --- | --- |
| Contact Operation Monitor* | --- | Yes | | --- | | | --- | | | --- | --- |
| Total ON Time Monitor* | --- | Yes | | --- | | | --- | | | --- | --- |
| Automatic Baud Rate Detection | Yes | Yes | | Yes | | | Yes | | | Yes | Yes |
| Unit Conduction Time Monitor | Yes | Yes | | --- | | | --- | | | Yes | Yes |
| Naming Units | Yes | Yes | | --- | | | --- | | | Yes | Yes |
| Naming Connected Devices | --- | Yes | | --- | | | --- | | | --- | Yes |
| Network Power Voltage Monitor | --- | Yes | | --- | | | --- | | | Yes | Yes |
| I/O Power Status Monitor | --- | --- | | --- | | | --- | | | --- | --- |
| Communications Error History Monitor | Yes | Yes | | --- | | | --- | | | Yes | Yes |
| Input Filter | --- | Yes | --- | Yes | --- | Yes | Yes | --- | Yes | --- | --- |
| Communications Error Output | --- | --- | Yes | --- | Yes | Yes | --- | Yes | Yes | --- | --- |
| Preventing Malfunctions Caused by Inrush Current at I/O Startup | --- | Yes | --- | --- | | | --- | | | --- | --- |
| Power Short-circuit Detection | --- | Yes | --- | --- | | | --- | | | --- | --- |
| Unconnected Line Detection | --- | --- | | --- | | | --- | | | --- | --- |
| Load Short-circuit Detection | --- | --- | Yes | --- | | | --- | | | --- | --- |
| Disconnected Line Detection | --- | --- | | --- | | | --- | | | --- | --- |
| Removable Terminal Block Structure | --- | --- | | --- | | | --- | | | --- | --- |
| Expansion Using Expansion Units | --- | --- | | --- | | | --- | | | --- | --- |
| Scaling | --- | --- | | --- | | | --- | | | --- | --- |
| Last Maintenance Date | --- | Yes | | --- | | | --- | | | Yes | --- |
| Cumulated Count | --- | --- | | --- | | | --- | | | --- | --- |
| Moving Average | --- | --- | | --- | | | --- | | | --- | --- |
| Setting the Number of AD Conversion Points | --- | --- | | --- | | | --- | | | --- | --- |
| Rate of Change | --- | --- | | --- | | | --- | | | --- | --- |
| Comparator | --- | --- | | --- | | | --- | | | --- | --- |
| Peak/Bottom Hold | --- | --- | | --- | | | --- | | | --- | --- |
| Top/Valley Hold | --- | --- | | --- | | | --- | | | --- | --- |
| User Adjustment | --- | --- | | --- | | | --- | | | --- | --- |
| Top/Valley Count | --- | --- | | --- | | | --- | | | --- | --- |
| Temperature Range Total Time Count | --- | --- | | --- | | | --- | | | --- | --- |
| Input Temperature Variation Detection | --- | --- | | --- | | | --- | | | --- | --- |
| Input Error Detection Disable Function | --- | --- | | --- | | | --- | | | --- | --- |

* The Contact Operation Monitor and the Total ON Time Monitor cannot be used at the same time for the same contact.

What Are Smart Functions?

Smart Functions

Network Power Voltage Monitor

The Network Power Voltage Monitor function stores the present value, minimum value, and maximum value of the network power voltage in the Slave Unit memory. If a monitor voltage is set using the CX-Integrator, the monitor voltage is stored in the Slave Unit memory. (The default is 14 V.) If the voltage drops below the monitor voltage, a flag in a status area in the Slave Unit will turn ON to notify the Master Unit. The notification details can be read using the CX-Integrator or using explicit messages.

- Note 1.** The minimum communications power voltage for the CompoNet network itself is 14 V, so if the network power voltage drops below 14 V, it may not be possible to read a measurement value using the CX-Integrator.
- 2.** The maximum and minimum values of the network power voltage are cleared when the network power is turned OFF.

Unit Conduction Time Monitor

The cumulative time that power is ON to the Slave Unit's internal circuits can be stored in the Slave Unit memory. (This data can be read using the CX-Integrator or using explicit messages.) The monitor value is also stored in the Slave Unit memory so once the total time reaches the monitor value, a flag in a status area in the Slave Unit turns ON to notify the Master Unit.

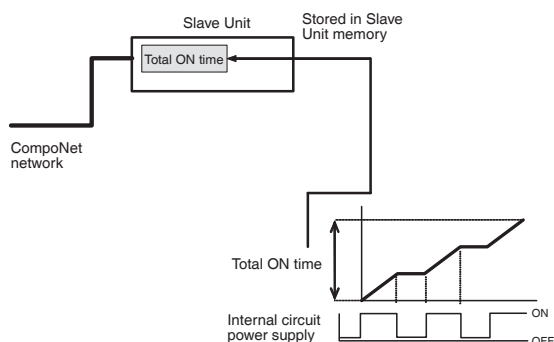

Naming Units

The user can set any name for each Unit (up to 32 characters) as a comment. The name is stored in the Slave Unit memory. The CX-Integrator or explicit messages can be used to read/write the name (i.e., the comment).

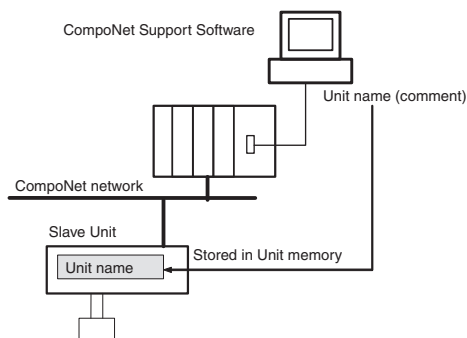

Naming Connected Devices

The user can set any name for each I/O contact in the Unit (up to 32 characters). These names are stored in the Slave Unit memory. Connected devices can be checked for each I/O contact, which is useful for remote maintenance and other applications where, for example, devices with errors need to be identified.

The CX-Integrator or explicit messages can be used to read/write the name (i.e., comment).

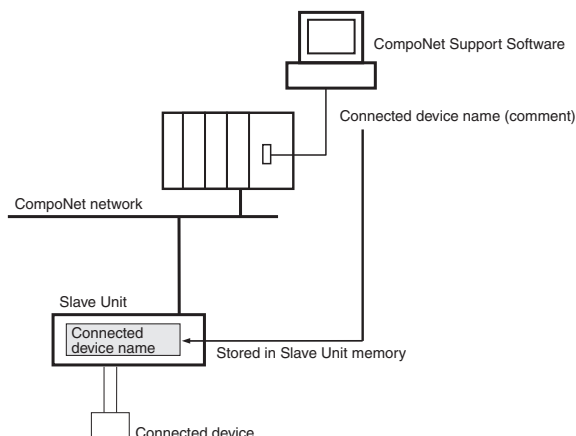

Communications Error History Monitor

Enables storing the error (communication failure details, the communications power supply voltage at the time of failure, and the Unit conduction time) for the most recent 4 communication failures within the slave unit.

The communications error history can be read using the CX-Integrator.

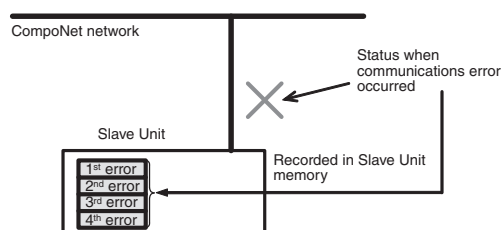

Last Maintenance Date

This function can be used to write the date maintenance was last performed in the Slave Unit memory. This makes it easier to decide when the next maintenance should be performed next. This maintenance date can be written using the CX-Integrator.

Contact Operation Monitor (Digital I/O Slave, Bit Slave Input Units Only)

The number of times each input contact or output contact is turned ON can be counted (resolution: 50 Hz max.) and stored in Slave Unit memory. (This data can be read using the CX-Integrator or using explicit messages.)

A monitor value can also be stored in the Slave Unit memory so once the number of contact operations reaches the monitor value, a flag in a status area in the Slave Unit turns ON to notify the Master Unit. The notification details can be read using the CX-Integrator or using explicit messages.

- No. of times measured: 0 to 4,294,967,295 (Stored data: 0000 0000 to FFFF FFFF hex)
- Measurement unit: No. of operations

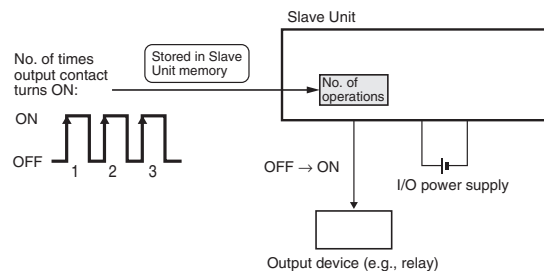

- Note 1.** The contact operation monitor and the total ON time monitor cannot both be used for the same contact at the same time. Select only one of these functions under the *Detection Mode*.
- 2.** This function does not operate if the I/O power is not turned ON.

● **Total ON Time Monitor (Digital I/O Slave, Bit Slave Input Units Only)**

This function totals the time that each input and output contact is ON (unit: s) and stores this total time in the Slave Unit memory. (This data can be read using the CX-Integrator or using explicit messages.)

A monitor value can also be stored in the Slave Unit memory so once the set total time has been reached, a flag in a status area in the Slave Unit turns ON to notify the Master Unit. The notification details can be read using the CX-Integrator or using explicit messages.

- Measurement time: 0 to 4,294,967,295 s (Stored data: 0000 0000 to FFFF FFFF Hex)
- Measurement unit: s

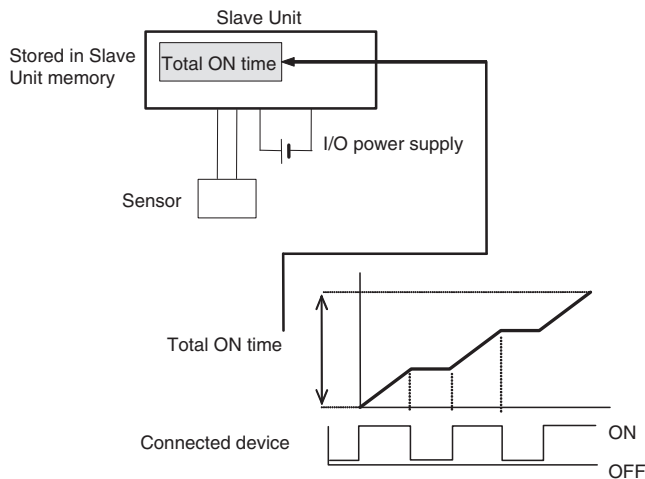

- Note 1.** The total ON time monitor and the contact operation monitor cannot both be used for the same contact at the same time. Select only one of these functions under the *Detection Mode*.
- 2.** This function does not operate if the I/O power is not turned ON.
- 3.** The Total ON Time Monitor Function checks at 1 second intervals whether or not the connected device is turned ON.

● **Input Filter (Digital I/O Slave, Bit Slave Input Units Only)**

An input value is read more than once during a set time interval. The input value can be set to be enabled only when all the read values are the same.

This function operates for all input points in one Slave Unit.

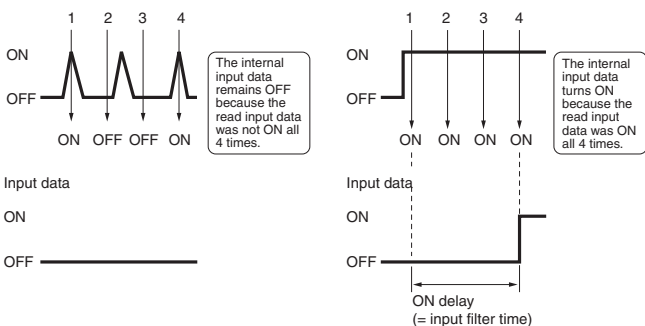

● **Error Prevention for Surge Current at Startup (Digital I/O Slave Units and Bit Slave Input Units Only)**

This function can be used to prevent reading inputs while the I/O power is OFF and for 100 ms after the I/O power is turned ON (i.e., until the Slave Unit stabilizes). It helps avoid input errors caused by inrush current from connected devices when the I/O power supply is turned ON. This function is enabled or disabled by the CX-Integrator or by explicit messages.

● **I/O Power Status Monitor (Digital I/O Slave Units Only)**

The I/O power status monitor function can be used to detect whether the I/O power is ON.

When the I/O power is turned OFF, a flag in a status area in the Slave Unit turns ON to notify the Master Unit. The notification details can be read using the CX-Integrator or using explicit messages.

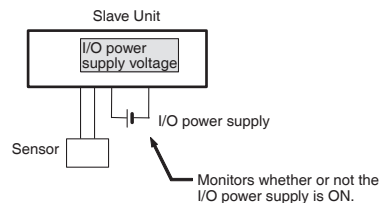

Note: A detection voltage cannot be set for the I/O power supply.

● **Sensor Power Short-circuit Detection (Bit Slave Units Only)**

This function monitors the current in the sensor power supply section and detects a power supply short-circuit if the current per input contact exceeds a rated value. Power supply short-circuit detection functions in two different ways depending on Unit specifications. For some Units, the I/O power supply is turned OFF to the entire Unit if a short-circuit is detected for even one input.

For other Units, the I/O power is turned OFF individually for each input.

For information on load short-circuit detection, refer to the power short-circuit protection and input device power supply specifications for the applicable Unit.

An indicator on the Slave Unit can be used to see if a power supply short-circuit has been detected. Also, if a short-circuit has been detected, an internal status bit will turn ON in the Slave Unit to inform the Master Unit. The current status can be read using the CX-Integrator or an explicit message. Once the cause of the short-circuit has been removed, operation will recover automatically and power will be output to the connector where the short-circuit was detected.

Note: Use a power supply device with a rating of 100 W or higher as the communications power supply for network power supply. A short-circuit is detected if a current that exceeds a specified value flows in the sensor power supply output of the Unit. Also, the communications power supply may temporarily turn OFF when a short circuit occurs. Operation will automatically be restored once the cause of the short circuit has been removed, but implement an external circuit so that the system operates safely while the outputs are turned OFF. Use the following formula as a guide for Sensor communications power supply capacity.

- Total network current = Total Unit current consumption + Total Sensor current consumption
- Communications power supply capacity used \geq (Total network current + (Short-circuit detection current)) • (CompoNet network voltage used)

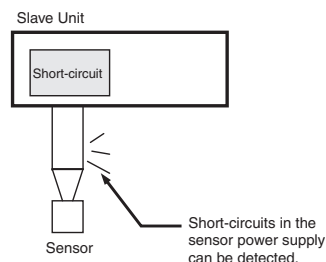

● **Load Short-circuit Detection (Output Only) (Bit Slave Units Only)**

This function monitors the load current in the output section and detects a load short-circuit if the current per contact (or common) exceeds a rated value. If a load short-circuited is detected, the outputs are turned OFF to prevent damage to the Unit output circuits. Load short-circuit detection functions in two different ways depending on Unit specifications. For some Units, the outputs are turned OFF for the entire Unit if a short-circuit is detected for even one output. For other Units, the outputs are turned OFF individually. For information on load short-circuit detection, refer to the rated output current and internal circuits in the specifications for the applicable Unit.

An indicator on the Slave Unit can be used to see if a load short-circuit has been detected. Also, if a short-circuit has been detected, an internal status bit will turn ON in the Slave Unit to inform the Master Unit. The current status can be read using the CX-Integrator or an explicit message. Once the cause of the short-circuit has been removed, operation will recover automatically and power will be output to the connector where the short-circuit was detected.

Note: An OMRON S82J-series Power Supply device is recommended for the I/O power supply. Load short-circuits may not be detected if a power supply with vertical-drop overcurrent protection characteristics is used. If a power supply device with vertical-drop overcurrent protection characteristics is used, use one with a rating of 100 W min.

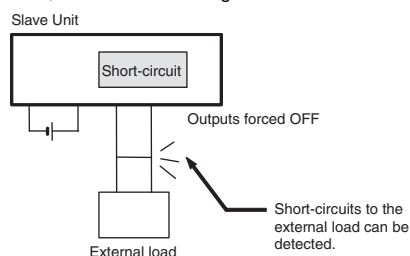

Basic Specification of Slave Units

Performance Specifications

| Item | Specification |
|---|---|
| Communications power supply voltage | 14 to 26.4 VDC |
| I/O power supply voltage *1 | 20.4 to 26.4 VDC (24 VDC -15%/+10%) |
| Noise immunity | Conforms to IEC 61000-4-4, 2 kV (power line). |
| Vibration resistance | 10 to 60 Hz with double-amplitude of 0.7 mm, 60 to 150 Hz and 50 m/s ² in X, Y, and Z directions for 80 min each |
| Shock resistance | 150 m/s ² (3 times each in 6 directions on 3 axes) |
| Dielectric strength | 500 VAC (between isolated circuits) |
| Insulation resistance | 20 MΩ min. (between isolated circuits) |
| Ambient operating temperature | -10 to 55°C |
| Ambient operating humidity | 25% to 85% (with no condensation) |
| Ambient operating atmosphere | No corrosive gases |
| Storage temperature | -25 to 65°C |
| Storage humidity | 25% to 85% (with no condensation) |
| Terminal block screw tightening torque *2 | M3 wiring screws: 0.5 N·m M3 mounting screws: 0.5 N·m |
| Installation | Mounted on 35-mm DIN Track or Mounting Bracket, or secured with M4 screws (depending on model) |

*1 The I/O power supply is called the sensor power supply in information for the CRT1-VAD04S.

*2 Applicable only to Slaves to which screw terminal blocks are mounted.

Some of the specifications are different for the CRT1-ROS08/ROS16 (with relay outputs) and the CRT1-ROF08/ROF16 (with SSR outputs). Refer to the pages of specifications for individual Slaves for details.

Digital I/O Slave Units with Screw Terminal Blocks (2-tier Terminal Block/Relay Output/SSR Output)

CRT1-□D08(-1)/□D16(-1)/ROS□/ROF□

Visualize the actual worksite status! Simple and Intelligent I/O Slave Units.

In addition to the Digital I/O Slave Unit's basic digital ON/OFF signals, collect useful information from the Slave Unit to improve equipment operating rates and maintainability.



- Communications connector and removable I/O terminal block enable faster startup times and improved maintainability.
- One Expansion Unit can be added to each Digital I/O Slave Unit to increase system configuration flexibility.
- Collect various preventive maintenance data required to improve productivity, such as information on equipment deterioration due to aging and equipment operating time data.
- Simplify startup with the communications power supply monitoring function.

Ordering Information

| Name | Specifications | | | Model |
|---|------------------------|------------|-------------|---------------|
| Two-tier Screw Terminal Block | Inputs | 8 inputs | NPN | CRT1-ID08 |
| | | | PNP | CRT1-ID08-1 |
| | Outputs | 8 outputs | NPN | CRT1-OD08 |
| | | | PNP | CRT1-OD08-1 |
| | Inputs | 16 inputs | NPN | CRT1-ID16 * |
| | | | PNP | CRT1-ID16-1 * |
| | Outputs | 16 outputs | NPN | CRT1-OD16 * |
| | | | PNP | CRT1-OD16-1 * |
| Inputs/Outputs | 8 inputs/ 8 outputs | NPN | CRT1-MD16 | |
| | | PNP | CRT1-MD16-1 | |
| Screw Terminal Block with Relay Outputs | Outputs | 8 outputs | Contacts | CRT1-ROS08 |
| | | 16 outputs | | CRT1-ROS16 |
| Screw Terminal Block with SSR Outputs | Outputs | 8 outputs | SSR | CRT1-ROF08 |
| | | 16 outputs | | CRT1-ROF16 |

* These Units are also available with a DCN-TB4 Terminal Conversion Adapter included in the package. Add "(-B)" to the end of the model number to receive the Adapter as well.

● Expansion Units

One Expansion Unit can be combined with one Digital I/O Slave Unit (CRT1-ID16(-1), CRT1-OD16(-1), CRT1-ROS16, or CRT1-ROF16). The following Expansion Units are available. They can be combined in various ways for flexible I/O capacity expansion.

| Model | I/O points | Input capacity | Output capacity |
|------------|-----------------------------|----------------|-----------------|
| XWT-ID08 | 8 DC inputs (NPN) | 8 | 0 |
| XWT-ID08-1 | 8 DC inputs (PNP) | 8 | 0 |
| XWT-OD08 | 8 transistor outputs (NPN) | 0 | 8 |
| XWT-OD08-1 | 8 transistor outputs (PNP) | 0 | 8 |
| XWT-ID16 | 16 DC inputs (NPN) | 16 | 0 |
| XWT-ID16-1 | 16 DC inputs (PNP) | 16 | 0 |
| XWT-OD16 | 16 transistor outputs (NPN) | 0 | 16 |
| XWT-OD16-1 | 16 transistor outputs (PNP) | 0 | 16 |

Performance Specifications for CRT1-ROS08/ROS16 (with relay outputs) and CRT1-ROF08/ROF16 (with SSR outputs)

For Basic Performance Specifications of Slave Units, refer to page 30.

● Relay Output

| Item | Specification |
|---|--|
| Communications power supply voltage | 14 to 26.4 VDC |
| Noise immunity | Conforms to IEC 61000-4-4, 2 kV (power line). |
| Vibration resistance | 10 to 55 Hz with double-amplitude of 0.7 mm X, Y, and Z directions for 80 min each |
| Shock resistance | 100 m/s ² (3 times in 6 directions on 3 axes) |
| Dielectric strength | 500 VAC (between isolated circuits) |
| Insulation resistance | 20 MΩ min. (between isolated circuits) |
| Ambient operating temperature | -10 to 55°C |
| Ambient operating humidity | 25% to 85% (with no condensation) |
| Ambient operating atmosphere | No corrosive gases |
| Storage temperature | -25 to 65°C |
| Storage humidity | 25% to 85% (with no condensation) |
| Terminal block screws tightening torque | M3 wiring screws: 0.5 N·m M3 mounting screws: 0.5 N·m |

● SSR Output

| Item | Specification |
|---|---|
| Communications power supply voltage | 14 to 26.4 VDC |
| Noise immunity | Conforms to IEC 61000-4-4, 2 kV (power line). |
| Vibration resistance | 10 to 60 Hz with double-amplitude of 0.7 mm, 60 to 150 Hz and 50 m/s ² in X, Y, and Z directions for 80 min each |
| Shock resistance | 150 m/s ² (3 times in 6 directions on 3 axes) |
| Dielectric strength | 500 VAC (between isolated circuits) |
| Insulation resistance | 20 MΩ min. (between isolated circuits) |
| Ambient operating temperature | -10 to 55°C |
| Ambient operating humidity | 25% to 85% (with no condensation) |
| Ambient operating atmosphere | No corrosive gases |
| Storage temperature | -25 to 65°C |
| Storage humidity | 25% to 85% (with no condensation) |
| Terminal block screws tightening torque | M3 wiring screws: 0.5 N·m M3 mounting screws: 0.5 N·m |

Input Section Specifications

● Eight-point Input Units (2-tier Terminal Block)

| Item | Specification | |
|---|--|--|
| | CRT1-ID08 | CRT1-ID08-1 |
| Model | CRT1-ID08 | CRT1-ID08-1 |
| I/O capacity | 8 inputs | |
| Internal I/O common | NPN | PNP |
| ON voltage | 15 VDC min. (between each input terminal and the V terminal) | 15 VDC min. (between each input terminal and the G terminal) |
| OFF voltage | 5 VDC max. (between each input terminal and the V terminal) | 5 VDC max. (between each input terminal and the G terminal) |
| OFF current | 1.0 mA max. | |
| Input current | At 24 VDC: 6.0 mA max./input At 17 VDC: 3.0 mA min./input | |
| ON delay | 1.5 ms max. | |
| OFF delay | 1.5 ms max. | |
| Number of circuits per common | 8 inputs/common | |
| Isolation method | Photocoupler | |
| Input indicator | LED (yellow) | |
| Installation | DIN Track | |
| Power supply type | Multi-power supply | |
| Communications power supply current consumption | 30 mA max. for 24-VDC power supply voltage 50 mA max. for 14-VDC power supply voltage | |
| I/O power supply current consumption | 5 mA max. for 24-VDC power supply voltage | |
| Weight | 160 g max. | |

● Sixteen-point Input Units (2-tier Terminal Block)

| Item | Specification | |
|---|--|--|
| | CRT1-ID16 | CRT1-ID16-1 |
| Model | CRT1-ID16 | CRT1-ID16-1 |
| I/O capacity | 16 inputs | |
| Internal I/O common | NPN | PNP |
| ON voltage | 15 VDC min. (between each input terminal and the V terminal) | 15 VDC min. (between each input terminal and the G terminal) |
| OFF voltage | 5 VDC max. (between each input terminal and the V terminal) | 5 VDC max. (between each input terminal and the G terminal) |
| OFF current | 1 mA max. | |
| Input current | At 24 VDC: 6.0 mA max./input At 17 VDC: 3.0 mA max./input | |
| ON delay | 1.5 ms max. | |
| OFF delay | 1.5 ms max. | |
| Number of circuits per common | 16 inputs/common | |
| Isolation method | Photocoupler | |
| Input indicator | LED (yellow) | |
| Installation | DIN Track mounting | |
| Power supply type | Multi-power supply | |
| Communications power supply current consumption | 55 mA max. for 24-VDC power supply voltage 85 mA max. for 14-VDC power supply voltage | |
| I/O power supply current consumption | 5 mA max. for 24-VDC power supply voltage | |
| Weight | 141 g max. | |

Output Section Specifications

● Eight-point Output Units (2-tier Terminal Block)

| Item | Specification | |
|---|--|--|
| Model | CRT1-OD08 | CRT1-OD08-1 |
| I/O capacity | 8 outputs | |
| Internal I/O common | NPN | PNP |
| Rated output current | 0.5 A/output, 2 A/common | |
| Residual voltage | 1.2 V max. (0.5 A DC, between each output terminal and the G terminal) | 1.2 V max. (0.5 A DC, between each output terminal and the V terminal) |
| Leakage current | 0.1 mA max. | |
| ON delay | 0.5 ms max. | |
| OFF delay | 1.5 ms max. | |
| Number of circuits per common | 8 outputs/common | |
| Isolation method | Photocoupler | |
| Output indicators | LED (yellow) | |
| Installation | DIN Track | |
| Power supply type | Multi-power supply | |
| Communications power supply current consumption | 35 mA max. for 24-VDC power supply voltage 55 mA max. for 14-VDC power supply voltage | |
| I/O power supply current consumption | 15 mA max. for 24-VDC power supply voltage | |
| Output handling for communications errors | Select either hold or clear from CX-Integrator. | |
| Weight | 160 g max. | |

● Sixteen-point Output Units (2-tier Terminal Block)

| Item | Specification | |
|---|--|--|
| Model | CRT1-OD16 | CRT1-OD16-1 |
| I/O capacity | 16 outputs | |
| Internal I/O common | NPN | PNP |
| Rated output current | 0.5 A/output, 4 A/common | |
| Residual voltage | 1.2 V max. (0.5 A DC, between each output terminal and the G terminal) | 1.2 V max. (0.5 A DC, between each output terminal and the V terminal) |
| Leakage current | 0.1 mA max. | |
| ON delay | 0.5 ms max. | |
| OFF delay | 1.5 ms max. | |
| Number of circuits per common | 16 outputs/common | |
| Isolation method | Photocoupler | |
| Output indicators | LED (yellow) | |
| Installation | DIN Track mounting | |
| Power supply type | Multi-power supply | |
| Communications power supply current consumption | 55 mA max. for 24-VDC power supply voltage 85 mA max. for 14-VDC power supply voltage | |
| I/O power supply current consumption | 15 mA max. for 24-VDC power supply voltage | |
| Output handling for communications errors | Hold or clear can be selected. (CX-Integrator) | |
| Weight | 141 g max. | |

● Eight-point Output Units (Relay Outputs)

| Item | Specification |
|---|---|
| Model | CRT1-ROS08 |
| I/O capacity | 8 outputs |
| Mounted Relays | DRTA-NY5W-K (5 VDC) |
| Rated load | Resistive load 250 VAC, 2 A, common: 8 A 30 VDC, 2 A, common: 8 A |
| Rated ON current | 3 A |
| Maximum contact voltage | 250 VAC, 125 VDC |
| Maximum contact current | 3 A |
| Maximum switching capacity | 750 VA AC, 90 W DC |
| Minimum applicable load (reference value) | 5 VDC, 1 mA |
| Mechanical service life | 20,000,000 operations min. |
| Electrical service life | 100,000 operations min. |
| Installation method | DIN Track |
| Communications power supply current consumption | 95 mA max. for 24-VDC power supply voltage 150 mA max. for 14-VDC power supply voltage |
| Output hold for communications errors | Select either hold or clear from CX-Integrator. |
| Weight | 170 g max. |

● Sixteen-point Output Units (Relay Outputs) (per Output)

| Item | Specification |
|---|--|
| Model | CRT1-ROS16 |
| I/O capacity | 16 outputs |
| Mounted Relays | DRTA-NY5W-K (5 VDC) |
| Rated load | Resistive load 250 VAC, 2 A, common: 8 A 30 VDC, 2 A, common: 8 A |
| Rated ON current | 3 A |
| Maximum contact voltage | 250 VAC, 125 VDC |
| Maximum contact current | 3 A |
| Maximum switching capacity | 750 VA AC, 90 W DC |
| Minimum applicable load (reference value) | 5 VDC, 1 mA |
| Mechanical service life | 20,000,000 operations min. |
| Electrical service life | 100,000 operations min. |
| Installation | DIN Track mounting |
| Communications power supply current consumption | 155 mA max. for 24-VDC power supply voltage 255 mA max. for 14-VDC power supply voltage |
| Output hold for communications errors | Hold or clear can be selected. (CX-Integrator) |
| Weight | 260 g max. |

● Eight-point Output Units (SSR Outputs) (per Output)

| Item | Specification |
|---|--|
| Model | CRT1-ROF08 |
| I/O capacity | 8 outputs |
| Load voltage | 24 to 265 VAC |
| Load current | 0.3 A |
| Inrush current resistivity | 50 A (60 Hz) |
| Installation method | DIN Track |
| Communications power supply current consumption | 60 mA max. for 24-VDC power supply voltage 90 mA max. for 14-VDC power supply voltage |
| Output hold for communications errors | Select either hold or clear from CX-Integrator. |
| Weight | 160 g max. |

Note: The SSRs cannot be replaced.

● Sixteen-point Output Units (SSR Outputs) (per Output)

| Item | Specification |
|---|---|
| Model | CRT1-ROF16 |
| I/O capacity | 16 outputs |
| Load voltage | 24 to 265 VAC |
| Load current | 0.3 A |
| Inrush current resistivity | 50 A (60 Hz) |
| Installation | DIN Track mounting |
| Communications power supply current consumption | 85 mA max. for 24-VDC power supply voltage 130 mA max. for 14-VDC power supply voltage |
| Output hold for communications errors | Hold or clear can be selected. (CX-Integrator) |
| Weight | 250 g max. |

Note: The SSRs cannot be replaced.

Load Current vs. Ambient Temperature

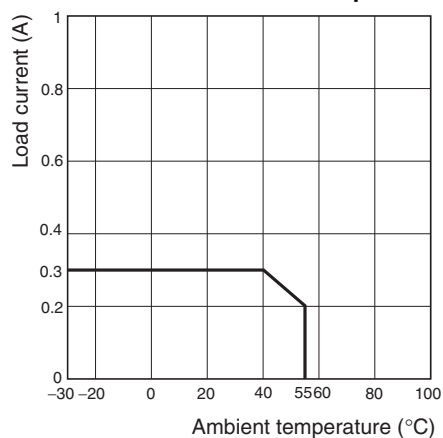

Input and Output Section Specifications

● Eight-point Input and Eight-point Output Units (2-tier Terminal Block)

CRT1-MD16/CRT1-MD16-1

Common Specifications

| Item | Specification | |
|---|--|-------------|
| Model | CRT1-MD16 | CRT1-MD16-1 |
| Installation | DIN Track | |
| Communications power supply current consumption | 35 mA max. for 24-VDC power supply voltage 60 mA max. for 14-VDC power supply voltage | |
| Weight | 170 g max. | |

Input Section Specifications

| Item | Specification | |
|--------------------------------------|---|---|
| Model | CRT1-MD16 | CRT1-MD16-1 |
| I/O capacity | 8 inputs | |
| Internal I/O common | NPN | PNP |
| ON voltage | 15 VDC min. (between each input terminal and the V terminal) | 15 VDC min. (between each input terminal and the G terminal) |
| OFF voltage | 5 VDC max. (between each input terminal and the V terminal) | 5 VDC max. (between each input terminal and the G terminal) |
| OFF current | 1.0 mA max. | |
| Input current | At 24 VDC: 6.0 mA max./input At 17 VDC: 3.0 mA min./input | |
| ON delay | 1.5 ms max. | |
| OFF delay | 1.5 ms max. | |
| Number of circuits per common | 8 inputs/common | |
| Isolation method | Photocoupler | |
| Input indicator | LED (yellow) | |
| Power supply type | Multi-power supply | |
| I/O power supply current consumption | 5 mA max. for 24-VDC power supply voltage | |

Output Section Specifications

| Item | Specification | |
|---|--|--|
| Model | CRT1-MD16 | CRT1-MD16-1 |
| I/O capacity | 8 outputs | |
| Internal I/O common | NPN | PNP |
| Rated output current | 0.5 A/output, 2A/common | |
| Residual voltage | 1.2 V max. (0.5 A DC, between each output terminal and the G terminal) | 1.2 V max. (0.5 A DC, between each output terminal and the V terminal) |
| Leakage current | 0.1 mA max. | |
| ON delay | 0.5 ms max. | |
| OFF delay | 1.5 ms max. | |
| Number of circuits per common | 8 outputs/common | |
| Isolation method | Photocoupler | |
| Output indicators | LED (yellow) | |
| I/O power supply current consumption | 15 mA max. for 24-VDC power supply voltage | |
| Output handling for communications errors | Select either hold or clear from CX-Integrator. | |

Dimensions

(Unit: mm)

CRT1-ID08 (-1)
 CRT1-OD08 (-1)

When a DCN4-TB4 Open Type Connectors Is Mounted

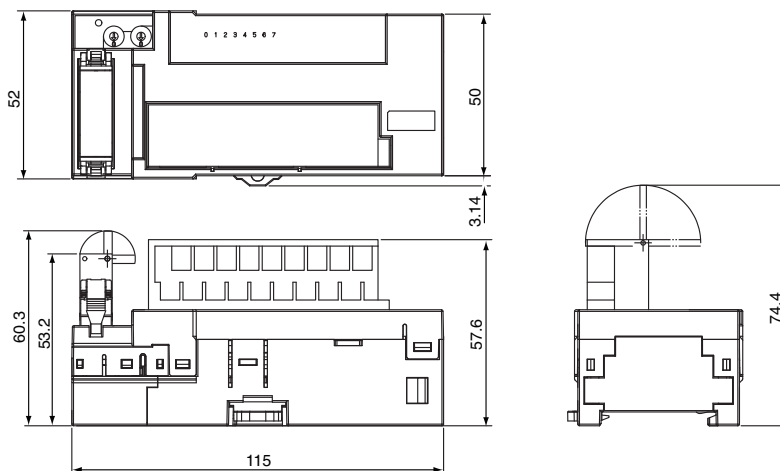

CRT1-ID16 (-1)
 CRT1-OD16 (-1)

When a DCN4-TB4 Open Type Connectors Is Mounted

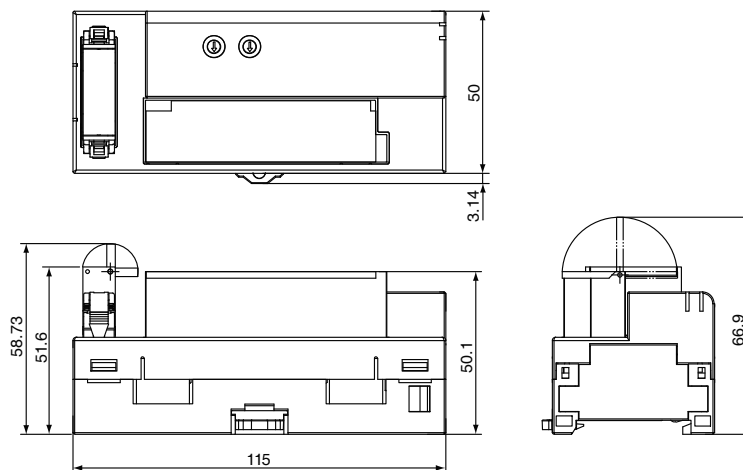

CRT1-MD16 (-1)

When a DCN4-TB4 Open Type Connectors Is Mounted

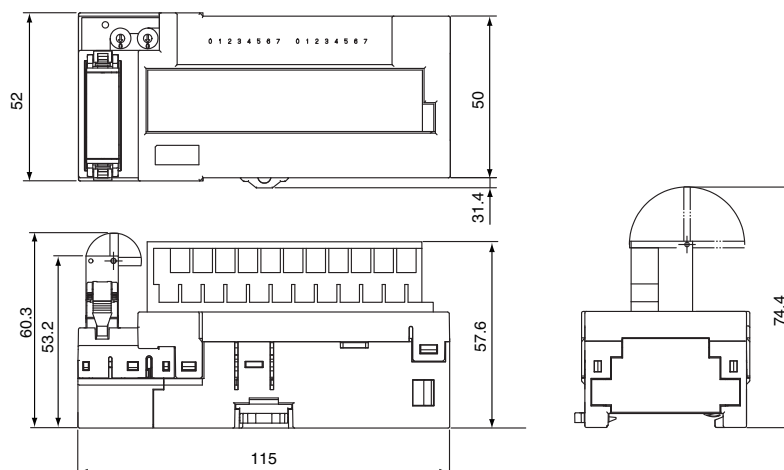

CRT1-ROS08
 CRT1-ROF08

When a DCN4-TB4 Open Type Connectors Is Mounted

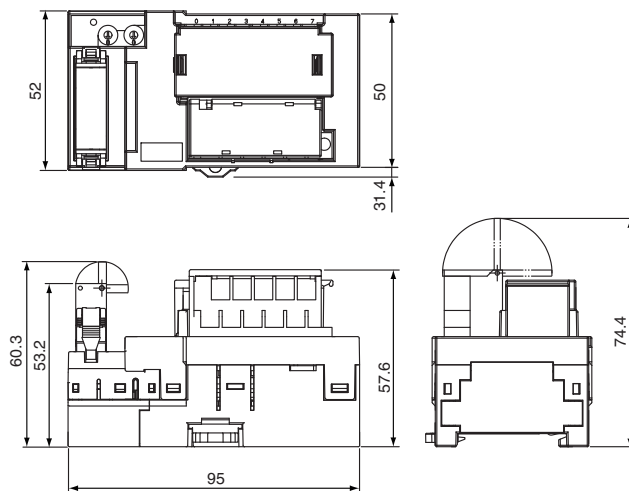

CRT1-ROS16
 CRT1-ROF16

When a DCN4-TB4 Open Type Connectors Is Mounted

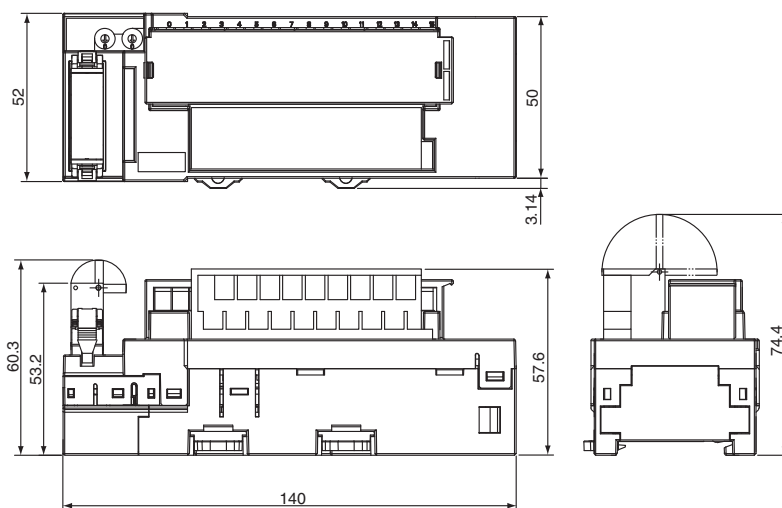

Digital I/O Slave Units with Screw Terminal Blocks (3-tier Terminal Block)

CRT1-□D08TA(-1)/□D16TA(-1)/□D08TAH(-1)/□D16TAH(-1)

**With the relay terminal blocks, doubling up wires on terminals is not necessary!
Smart Slave Units with Easy-to-understand Wiring Locations with One Common for Every Point.**

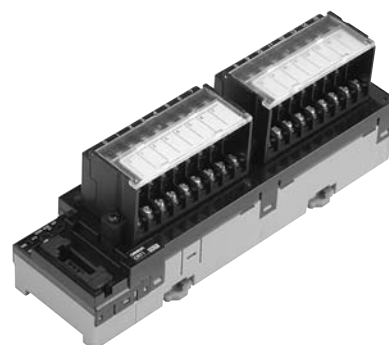

Doubling up wires on terminals is unnecessary and wiring locations are easy to understand with these Smart Slaves with 3-tier Terminal Blocks.

- Easy-to-understand wiring. No doubling up of wires. Easy-to-understand wiring locations.
- Simplify startup with the communications power supply monitor (Smart function).
- Collect various preventive maintenance data required to improve productivity, such as information on equipment deterioration due to aging and equipment operating time data (Smart function).
- The communications baud rate is set without using switches and addresses are set using rotary switches, so setting errors are reduced.
- Communications connector and removable I/O terminal block enable maintenance without disconnecting wiring.

Ordering Information

| Name | Specifications | | | | Model | |
|---------------------------------|------------------------|------------------------|----------------|---|--|----------------|
| Three-tier Screw Terminal Block | Inputs | 8 inputs | NPN | Without Short-circuit and Disconnected Line Detection | CRT1-ID08TA | |
| | | | PNP | | CRT1-ID08TA-1 | |
| | Outputs | 8 outputs | NPN | | CRT1-OD08TA | |
| | | | PNP | | CRT1-OD08TA-1 | |
| | Inputs | 16 inputs | NPN | | CRT1-ID16TA | |
| | | | PNP | | CRT1-ID16TA-1 | |
| | Outputs | 16 outputs | NPN | | CRT1-OD16TA | |
| | | | PNP | | CRT1-OD16TA-1 | |
| | Inputs/ Outputs | 8 inputs/ 8 outputs | NPN | | CRT1-MD16TA | |
| | | | PNP | | CRT1-MD16TA-1 | |
| | Inputs | 8 inputs | NPN | | With Short-circuit and Disconnected Line Detection | CRT1-ID08TAH |
| | | | PNP | | | CRT1-ID08TAH-1 |
| | Outputs | 8 outputs | NPN | | | CRT1-OD08TAH |
| | | | PNP | | | CRT1-OD08TAH-1 |
| | Inputs | 16 inputs | NPN | | | CRT1-ID16TAH |
| | | | PNP | | | CRT1-ID16TAH-1 |
| Outputs | 16 outputs | NPN | CRT1-OD16TAH | | | |
| | | PNP | CRT1-OD16TAH-1 | | | |
| Inputs/ Outputs | 8 inputs/ 8 outputs | NPN | CRT1-MD16TAH | | | |
| | | PNP | CRT1-MD16TAH-1 | | | |

Performance Specifications

For Basic Performance Specifications of Slave Units, refer to page 30.

Input Section Specifications

● Eight-point Input Units (3-tier Terminal Block)

| Item | Specification | | | |
|---|--|--|--|--|
| Model | CRT1-ID08TA | CRT1-ID08TA-1 | CRT1-ID08TAH-1 | CRT1-ID08TAH-1 |
| I/O capacity | 8 inputs | | | |
| Internal I/O common | NPN | PNP | NPN | PNP |
| ON voltage | 15 VDC min. (between each input terminal and the V terminal) | 15 VDC min. (between each input terminal and the G terminal) | 10.5 VDC min. (between each input terminal and the V terminal) | 10.5 VDC min. (between each input terminal and the G terminal) |
| OFF voltage | 5 VDC max. (between each input terminal and the V terminal) | 5 VDC max. (between each input terminal and the G terminal) | --- | --- |
| OFF current | 1.0 mA max. | | | |
| Input current | At 24 VDC: 6.0 mA max./input At 17 VDC: 3.0 mA min./input | | | |
| ON delay | 1.5 ms max. | | | |
| OFF delay | 1.5 ms max. | | | |
| Power supply short-circuit detection | --- | | Operates at 50 mA/point min. | |
| Disconnection detection | --- | | Operates at 0.3 mA/point max. | |
| Number of circuits per common | 8 inputs/common | | | |
| Isolation method | Photocoupler | | | |
| Input indicator | LED (yellow) | | | |
| Installation | DIN Track | | | |
| Power supply type | Multi-power supply | | | |
| Current supplied to input devices | 100 mA/point | | 50 mA/point | |
| Communications power supply current consumption | 30 mA max. for 24-VDC power supply voltage 50 mA max. for 14-VDC power supply voltage | | 35 mA max. for 24-VDC power supply voltage 60 mA max. for 14-VDC power supply voltage | |
| I/O power supply current consumption | 5 mA max. for 24-VDC power supply voltage | | 25 mA max. for 24-VDC power supply voltage | |
| Weight | 190 g max. | | 200 g max. | |

● Sixteen-point Input Units (3-tier Terminal Block)

| Item | Specification | | | |
|---|--|--|--|--|
| Model | CRT1-ID16TA | CRT1-ID16TA-1 | CRT1-ID16TAH | CRT1-ID16TAH-1 |
| I/O capacity | 16 inputs | | | |
| Internal I/O common | NPN | PNP | NPN | PNP |
| ON voltage | 15 VDC min. (between each input terminal and the V terminal) | 15 VDC min. (between each input terminal and the G terminal) | 10.5 VDC min. (between each input terminal and the V terminal) | 10.5 VDC min. (between each input terminal and the G terminal) |
| OFF voltage | 5 VDC max. (between each input terminal and the V terminal) | 5 VDC max. (between each input terminal and the G terminal) | --- | --- |
| OFF current | 1.0 mA max. | | | |
| Input current | At 24 VDC: 6.0 mA max./input At 17 VDC: 3.0 mA min./input | | | |
| ON delay | 1.5 ms max. | | | |
| OFF delay | 1.5 ms max. | | | |
| Power supply short-circuit detection | --- | | Operates at 50 mA/point min. | |
| Disconnection detection | --- | | Operates at 0.3 mA/point max. | |
| Number of circuits per common | 8 inputs/common | | | |
| Isolation method | Photocoupler | | | |
| Input indicator | LED (yellow) | | | |
| Installation | DIN Track | | | |
| Power supply type | Multi-power supply | | | |
| Communications power supply current consumption | 40 mA max. for 24-VDC power supply voltage 55 mA max. for 14-VDC power supply voltage | | 40 mA max. for 24-VDC power supply voltage 70 mA max. for 14-VDC power supply voltage | |
| I/O power supply current consumption | 5 mA max. for 24-VDC power supply voltage | | 25 mA max. for 24-VDC power supply voltage | |
| Weight | 330 g max. | | 340 g max. | |

Output Section Specifications

● Eight-point Output Units (3-tier Terminal Block)

| Item | Specification | | | |
|---|--|--|--|--|
| Model | CRT1-OD08TA | CRT1-OD08TA-1 | CRT1-OD08TAH | CRT1-OD08TAH-1 |
| I/O capacity | 8 outputs | | | |
| Internal I/O common | NPN | PNP | NPN | PNP |
| Rated output current | 0.5 A/output, 2 A/common | | | |
| Residual voltage | 1.2 V max. (0.5 A DC, between each output terminal and the G terminal) | 1.2 V max. (0.5 A DC, between each output terminal and the V terminal) | 1.2 V max. (0.5 A DC, between each output terminal and the G terminal) | 1.2 V max. (0.5 A DC, between each output terminal and the V terminal) |
| Leakage current | 0.1 mA max. | | | |
| ON delay | 0.5 ms max. | | | |
| OFF delay | 1.5 ms max. | | | |
| Load short-circuit detection | --- | | Supported. | |
| Disconnection detection | --- | | Operates at 3 mA/point max. (Does not operate at over 3 mA.) | |
| Number of circuits per common | 8 outputs/common | | | |
| Isolation method | Photocoupler | | | |
| Output indicators | LED (yellow) | | | |
| Installation | DIN Track | | | |
| Power supply type | Multi-power supply | | | |
| Current supplied to output devices | 100 mA/point | | | |
| Communications power supply current consumption | 35 mA max. for 24-VDC power supply voltage 55 mA max. for 14-VDC power supply voltage | | | |
| I/O power supply current consumption | 15 mA max. for 24-VDC power supply voltage | | 15 mA max. for 24-VDC power supply voltage | 35 mA max. for 24-VDC power supply voltage |
| Output handling for communications errors | Select either hold or clear from CX-Integrator. | | | |
| Weight | 190 g max. | | | |

● Sixteen-point Output Unit (3-tier Terminal Block)

| Item | Specification | | | |
|---|--|--|--|--|
| Model | CRT1-OD16TA | CRT1-OD16TA-1 | CRT1-OD16TAH | CRT1-OD16TAH-1 |
| I/O capacity | 16 outputs | | | |
| Internal I/O common | NPN | PNP | NPN | PNP |
| Rated output current | 0.5 A/output, 2 A/common | | | |
| Residual voltage | 1.2 V max. (0.5 A DC, between each output terminal and the G terminal) | 1.2 V max. (0.5 A DC, between each output terminal and the V terminal) | 1.2 V max. (0.5 A DC, between each output terminal and the G terminal) | 1.2 V max. (0.5 A DC, between each output terminal and the V terminal) |
| Leakage current | 0.1 mA max. | | | |
| ON delay | 0.5 ms max. | | | |
| OFF delay | 1.5 ms max. | | | |
| Number of circuits per common | 8 outputs/common | | | |
| Load short-circuit detection | --- | | Supported. | |
| Disconnection detection | --- | | Operates at 3 mA/point max. (Does not operate at over 3 mA.) | |
| Isolation method | Photocoupler | | | |
| Output indicators | LED (yellow) | | | |
| Installation | DIN Track | | | |
| Power supply type | Multi-power supply | | | |
| Communications power supply current consumption | 45 mA max. for 24-VDC power supply voltage 65 mA max. for 14-VDC power supply voltage | | 40 mA max. for 24-VDC power supply voltage 70 mA max. for 14-VDC power supply voltage | |
| I/O power supply current consumption | 15 mA max. for 24-VDC power supply voltage | | | 35 mA max. for 24-VDC power supply voltage |
| Output handling for communications errors | Select either hold or clear from CX-Integrator. | | | |
| Weight | 330 g max. | | | |

Input and Output Section Specifications

●8-point Input and 8-point Output Units (3-tier Terminal Block)

Common Specifications

| Item | Specification | | | |
|---|--|---------------|--|----------------|
| Model | CRT1-MD16TA | CRT1-MD16TA-1 | CRT1-MD16TAH | CRT1-MD16TAH-1 |
| Installation | DIN Track | | | |
| Communications power supply current consumption | 40 mA max. for 24-VDC power supply voltage 60 mA max. for 14-VDC power supply voltage | | 40 mA max. for 24-VDC power supply voltage 70 mA max. for 14-VDC power supply voltage | |
| Weight | 330 g max. | | 340 g max. | |

Input Section Specifications

| Item | Specification | | | |
|--------------------------------------|--|--|--|--|
| Model | CRT1-MD16TA | CRT1-MD16TA-1 | CRT1-MD16TAH | CRT1-MD16TAH-1 |
| I/O capacity | 8 inputs | | | |
| Internal I/O common | NPN | PNP | NPN | PNP |
| ON voltage | 15 VDC min. (between each input terminal and the V terminal) | 15 VDC min. (between each input terminal and the G terminal) | 10.5 VDC min. (between each input terminal and the V terminal) | 10.5 VDC min. (between each input terminal and the G terminal) |
| OFF voltage | 5 VDC max. (between each input terminal and the V terminal) | 5 VDC max. (between each input terminal and the G terminal) | --- | --- |
| OFF current | 1.0 mA max. | | | |
| Input current | At 24 VDC: 6.0 mA max./input At 17 VDC: 3.0 mA min./input | | | |
| ON delay | 1.5 ms max. | | | |
| OFF delay | 1.5 ms max. | | | |
| Power supply short-circuit detection | --- | | Operates at 50 mA/point min. | |
| Disconnection detection | --- | | Operates at 0.3 mA/point max. | |
| Number of circuits per common | 8 inputs/common | | | |
| Isolation method | Photocoupler | | | |
| Input indicator | LED (yellow) | | | |
| Power supply type | Multi-power supply | | | |
| I/O power supply current consumption | 5 mA max. for 24-VDC power supply voltage | | 25 mA max. for 24-VDC power supply voltage | |

Output Section Specifications

| Item | Specification | | | |
|---|--|--|--|--|
| Model | CRT1-MD16TA | CRT1-MD16TA-1 | CRT1-MD16TAH | CRT1-MD16TAH-1 |
| I/O capacity | 8 outputs | | | |
| Internal I/O common | NPN | PNP | NPN | PNP |
| Rated output current | 0.5 A/output, 2 A/common | | | |
| Residual voltage | 1.2 V max. (0.5 A DC, between each output terminal and the G terminal) | 1.2 V max. (0.5 A DC, between each output terminal and the V terminal) | 1.2 V max. (0.5 A DC, between each output terminal and the G terminal) | 1.2 V max. (0.5 A DC, between each output terminal and the V terminal) |
| Leakage current | 0.1 mA max. | | | |
| ON delay | 0.5 ms max. | | | |
| OFF delay | 1.5 ms max. | | | |
| Load short-circuit detection | --- | | Supported. | |
| Disconnection detection | --- | | Operates at 3 mA/point max. (Does not operate at over 3 mA.) | |
| Number of circuits per common | 8 outputs/common | | | |
| Isolation method | Photocoupler | | | |
| Output indicators | LED (yellow) | | | |
| I/O power supply current consumption | 15 mA max. for 24-VDC power supply voltage | | 35 mA max. for 24-VDC power supply voltage | |
| Output handling for communications errors | Select either hold or clear from CX-Integrator. | | | |

Dimensions

(Unit: mm)

CRT1-ID08TA (-1)
 CRT1-OD08TA(-1)

When a DCN4-TB4 Open Type Connectors Is Mounted

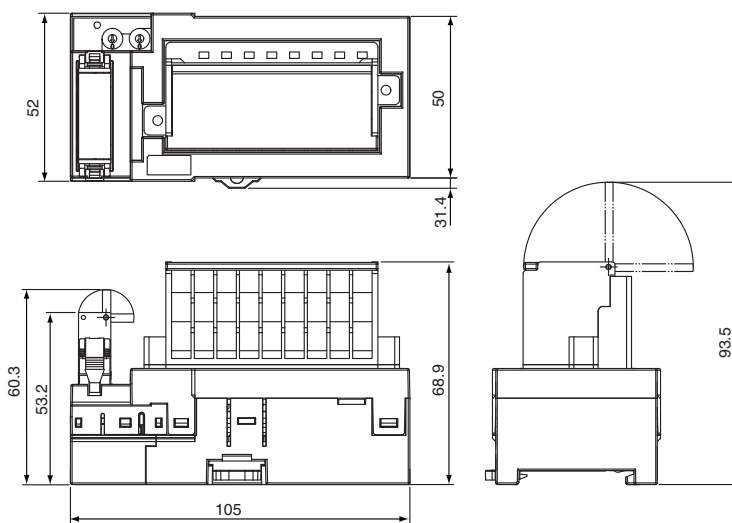

CRT1-ID16TA(-1)
 CRT1-OD16TA(-1)
 CRT1-MD16TA(-1)

When a DCN4-TB4 Open Type Connectors Is Mounted

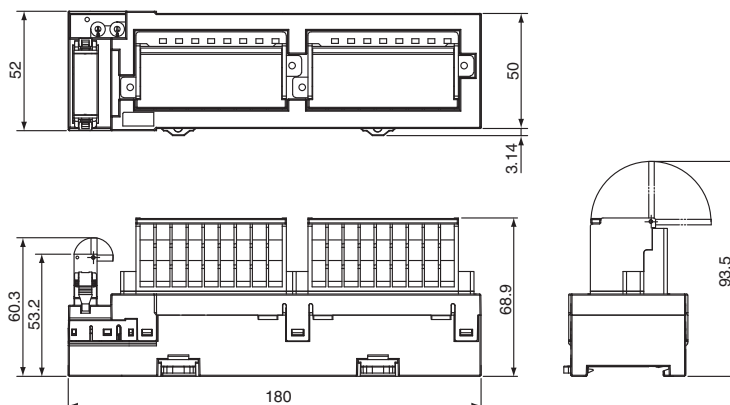

Digital I/O Slave Units with e-CON Connectors

CRT1-□D16S(-1)/□D32S(-1)/□D16SH(-1)/□D32SH(-1)

Industry-standard Sensor Connectors for Easy Connection to Pre-wired Sensors without Special Tools.

- A digital I/O terminal with industry-standard e-CON connectors.
- Easy to install without the use of special tools. Reduces wiring work.
- Equipped with load short-circuit detection.

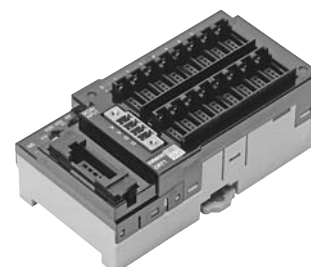

Ordering Information

| Name | Specifications | | | Model | |
|--------------------|---------------------------|---------------------------|---------------|---|---------------|
| e-CON Connectors | Inputs | 16 inputs | NPN | Without Short-circuit and Disconnected Line Detection | CRT1-ID16S |
| | | | PNP | | CRT1-ID16S-1 |
| | Outputs | 16 outputs | NPN | | CRT1-OD16S |
| | | | PNP | | CRT1-OD16S-1 |
| | Inputs/ Outputs | 8 inputs / 8 outputs | NPN | | CRT1-MD16S |
| | | | PNP | | CRT1-MD16S-1 |
| | Inputs | 32 inputs | NPN | | CRT1-ID32S |
| | | | PNP | | CRT1-ID32S-1 |
| | Outputs | 32 outputs | NPN | | CRT1-OD32S |
| | | | PNP | | CRT1-OD32S-1 |
| | Inputs/ Outputs | 16 inputs / 16 outputs | NPN | CRT1-MD32S | |
| | | | PNP | CRT1-MD32S-1 | |
| | Inputs | 16 inputs | NPN | With Short-circuit and Disconnected Line Detection | CRT1-ID16SH |
| | | | PNP | | CRT1-ID16SH-1 |
| | Outputs | 16 outputs | NPN | | CRT1-OD16SH |
| | | | PNP | | CRT1-OD16SH-1 |
| | Inputs/ Outputs | 8 inputs / 8 outputs | NPN | | CRT1-MD16SH |
| | | | PNP | | CRT1-MD16SH-1 |
| | Inputs | 32 inputs | NPN | | CRT1-ID32SH |
| | | | PNP | | CRT1-ID32SH-1 |
| Outputs | 32 outputs | NPN | CRT1-OD32SH | | |
| | | PNP | CRT1-OD32SH-1 | | |
| Inputs/ Outputs | 16 inputs / 16 outputs | NPN | CRT1-MD32SH | | |
| | | PNP | CRT1-MD32SH-1 | | |

Note. Output power supply connectors (Phoenix Contact K.K.) are provided with Output Units and I/O Units.

Slave External I/O Connections in the appendix for applicable connectors.

Performance Specifications

For Basic Performance Specifications of Slave Units, refer to page 30.

Input Section Specifications

● Sixteen-point Input Units

| Item | Specification | | | |
|---|--|--|--|--|
| Model | CRT1-ID16S | CRT1-ID16S-1 | CRT1-ID16SH | CRT1-ID16SH-1 |
| I/O capacity | 16 inputs | | | |
| Internal I/O common | NPN | PNP | NPN | PNP |
| ON voltage | 10.5 VDC min. (between each input terminal and the V terminal) | 10.5 VDC min. (between each input terminal and the G terminal) | 10.5 VDC min. (between each input terminal and the V terminal) | 10.5 VDC min. (between each input terminal and the G terminal) |
| OFF current | 1 mA max. | | | |
| Input current | At 24 VDC: 6.0 mA max./input At 11 VDC: 3.0 mA min./input | | | |
| ON delay | 1.5 ms max. | | | |
| OFF delay | 1.5 ms max. | | | |
| Power supply short-circuit detection | --- | | Operates at 50 mA/point min. | |
| Disconnection detection | --- | | Operates at 0.3 mA/point max. | |
| Number of circuits per common | 16 inputs/common | | | |
| Isolation method | Photocoupler | | | |
| Input indicator | LED (yellow) | | | |
| Installation | DIN Track | | | |
| Power supply type | Network power supply | | | |
| Power short-circuit protection | Operates at 50 mA/point min. | | | |
| Current supplied to input devices | 50 mA/input | | | |
| Communications power supply current consumption | 110 mA max. for 24-VDC power supply voltage 125 mA max. for 14-VDC power supply voltage | | 125 mA max. for 24-VDC power supply voltage 145 mA max. for 14-VDC power supply voltage | |
| Weight | 110 g max. | | | |

● Thirty-two-point Input Units

| Item | Specification | | | |
|---|--|--|--|--|
| Model | CRT1-ID32S | CRT1-ID32S-1 | CRT1-ID32SH | CRT1-ID32SH-1 |
| I/O capacity | 32 inputs | | | |
| Internal I/O common | NPN | PNP | NPN | PNP |
| ON voltage | 10.5 VDC min. (between each input terminal and the V terminal) | 10.5 VDC min. (between each input terminal and the G terminal) | 10.5 VDC min. (between each input terminal and the V terminal) | 10.5 VDC min. (between each input terminal and the G terminal) |
| OFF current | 1.0 mA max. | | | |
| Input current | At 24 VDC: 6.0 mA max./input At 11 VDC: 3.0 mA min./input | | | |
| ON delay | 1.5 ms max. | | | |
| OFF delay | 1.5 ms max. | | | |
| Power supply short-circuit detection | --- | | Operates at 50 mA/point min. | |
| Disconnection detection | --- | | Operates at 0.3 mA/point max. | |
| Number of circuits per common | 32 inputs/common | | | |
| Isolation method | Photocoupler | | | |
| Input indicator | LED (yellow) | | | |
| Installation | DIN Track | | | |
| Power short-circuit protection | Operates at 50 mA/point min. | | | |
| Power supply type | Network power supply | | | |
| Current supplied to input devices | 50 mA/input | | | |
| Communications power supply current consumption | 195 mA max. for 24-VDC power supply voltage 200 mA max. for 14-VDC power supply voltage | | 210 mA max. for 24-VDC power supply voltage 235 mA max. for 14-VDC power supply voltage | |
| Weight | 180 g max. | | | |

Output Section Specifications

● Sixteen-point Output Unit

| Item | Specification | | | |
|---|--|--|--|--|
| Model | CRT1-OD16S | CRT1-OD16S-1 | CRT1-OD16SH | CRT1-OD16SH-1 |
| I/O capacity | 16 outputs | | | |
| Internal I/O common | NPN | PNP | NPN | PNP |
| Rated output current | 0.5 A/output, 4 A/common | | | |
| Residual voltage | 1.2 V max. (0.5 A DC, between each output terminal and the G terminal) | 1.2 V max. (0.5 A DC, between each output terminal and the V terminal) | 1.2 V max. (0.5 A DC, between each output terminal and the G terminal) | 1.2 V max. (0.5 A DC, between each output terminal and the V terminal) |
| Leakage current | 0.1 mA max. | | | |
| ON delay | 0.5 ms max. | | | |
| OFF delay | 1.5 ms max. | | | |
| Load short-circuit detection | --- | | Supported. | |
| Disconnection detection | --- | | Operates at 3 mA/point max. (Does not operate at over 3 mA.) | |
| Number of circuits per common | 16 outputs/common | | | |
| Isolation method | Photocoupler | | | |
| Output indicators | LED (yellow) | | | |
| Installation | DIN Track | | | |
| Power supply type | Multi-power supply | | | |
| Current supplied to output devices | 100 mA/output | | | |
| Communications power supply current consumption | 40 mA max. for 24-VDC power supply voltage 60 mA max. for 14-VDC power supply voltage | | 40 mA max. for 24-VDC power supply voltage 65 mA max. for 14-VDC power supply voltage | |
| I/O power supply current consumption | 20 mA max. for 24-VDC power supply voltage | | 15 mA max. for 24-VDC power supply voltage | 60 mA max. for 24-VDC power supply voltage |
| Output handling for communications errors | Select either hold or clear from CX-Integrator. | | | |
| Weight | 110 g max. | | | |

● Thirty-two-point Output Unit

| Item | Specification | | | |
|---|--|--|--|--|
| Model | CRT1-OD32S | CRT1-OD32S-1 | CRT1-OD32SH | CRT1-OD32SH-1 |
| I/O capacity | 32 outputs | | | |
| Internal I/O common | NPN | PNP | NPN | PNP |
| Rated output current | 0.5 A/output, 4 A/common | | | |
| Residual voltage | 1.2 V max. (0.5 A DC, between each output terminal and the G terminal) | 1.2 V max. (0.5 A DC, between each output terminal and the V terminal) | 1.2 V max. (0.5 A DC, between each output terminal and the G terminal) | 1.2 V max. (0.5 A DC, between each output terminal and the V terminal) |
| Leakage current | 0.1 mA max. | | | |
| ON delay | 0.5 ms max. | | | |
| OFF delay | 1.5 ms max. | | | |
| Load short-circuit detection | --- | | Supported. | |
| Disconnection detection | --- | | Operates at 3 mA/point max. (Does not operate at over 3 mA.) | |
| Number of circuits per common | 16 outputs/common | | | |
| Isolation method | Photocoupler | | | |
| Output indicators | LED (yellow) | | | |
| Installation | DIN Track | | | |
| Power supply type | Multi-power supply | | | |
| Current supplied to output devices | 100 mA/output | | | |
| Communications power supply current consumption | 50 mA max. for 24-VDC power supply voltage 80 mA max. for 14-VDC power supply voltage | | 50 mA max. for 24-VDC power supply voltage 90 mA max. for 14-VDC power supply voltage | |
| I/O power supply current consumption | 15 mA max. for 24-VDC power supply voltage | | | 60 mA max. for 24-VDC power supply voltage |
| Output handling for communications errors | Select either hold or clear from CX-Integrator. | | | |
| Weight | 170 g max. | | | |

Input and Output Section Specifications

● 8-point Input and 8-point Output Units

Common Specifications

| Item | Specification | | | |
|---|--|--------------|---|---------------|
| Model | CRT1-MD16S | CRT1-MD16S-1 | CRT1-MD16SH | CRT1-MD16SH-1 |
| Installation | DIN Track | | | |
| Communications power supply current consumption | 75 mA max. for 24-VDC power supply voltage 95 mA max. for 14-VDC power supply voltage | | 95 mA max. for 24-VDC power supply voltage 115 mA max. for 14-VDC power supply voltage | |
| Weight | 120 g max. | | | |

Input Section Specifications

| Item | Specification | | | |
|--------------------------------------|--|--|--|--|
| Model | CRT1-MD16S | CRT1-MD16S-1 | CRT1-MD16SH | CRT1-MD16SH-1 |
| I/O capacity | 8 inputs | | | |
| Internal I/O common | NPN | PNP | NPN | PNP |
| ON voltage | 10.5 VDC min. (between each input terminal and the V terminal) | 10.5 VDC min. (between each input terminal and the G terminal) | 10.5 VDC min. (between each input terminal and the V terminal) | 10.5 VDC min. (between each input terminal and the G terminal) |
| OFF current | 1.0 mA max. | | | |
| Input current | At 24 VDC: 6.0 mA max./input At 11 VDC: 3.0 mA min./input | | | |
| ON delay | 1.5 ms max. | | | |
| OFF delay | 1.5 ms max. | | | |
| Power supply short-circuit detection | --- | | Operates at 50 mA/point min. | |
| Disconnection detection | --- | | Operates at 0.3 mA/point max. | |
| Number of circuits per common | 8 inputs/common | | | |
| Isolation method | Photocoupler | | | |
| Input indicator | LED (yellow) | | | |
| Power supply type | Network power supply | | | |
| Power short-circuit protection | Operates at 50 mA/point min. | | | |
| Current supplied to input devices | 50 mA/input | | | |

Output Section Specifications

| Item | Specification | | | |
|---|--|--|--|--|
| Model | CRT1-MD16S | CRT1-MD16S-1 | CRT1-MD16SH | CRT1-MD16SH-1 |
| I/O capacity | 8 outputs | | | |
| Internal I/O common | NPN | PNP | NPN | PNP |
| Rated output current | 0.5 A/output, 2 A/common | | | |
| Residual voltage | 1.2 V max. (0.5 A DC, between each output terminal and the G terminal) | 1.2 V max. (0.5 A DC, between each output terminal and the V terminal) | 1.2 V max. (0.5 A DC, between each output terminal and the G terminal) | 1.2 V max. (0.5 A DC, between each output terminal and the V terminal) |
| Leakage current | 0.1 mA max. | | | |
| ON delay | 0.5 ms max. | | | |
| OFF delay | 1.5 ms max. | | | |
| Load short-circuit detection | --- | | Supported. | |
| Disconnection detection | --- | | Operates at 3 mA/point max. (Does not operate at over 3 mA.) | |
| Number of circuits per common | 8 outputs/common | | | |
| Isolation method | Photocoupler | | | |
| Output indicators | LED (yellow) | | | |
| Power supply type | Multi-power supply | | | |
| Current supplied to output devices | 100 mA/output | | | |
| I/O power supply current consumption | 15 mA max. for 24-VDC power supply voltage | | | 35 mA max. for 24-VDC power supply voltage |
| Output handling for communications errors | Select either hold or clear from CX-Integrator. | | | |

●16-point Input and 16-point Output Units

Common Specifications

| Item | Specification | | | |
|---|--|--------------|--|---------------|
| Model | CRT1-MD32S | CRT1-MD32S-1 | CRT1-MD32SH | CRT1-MD32SH-1 |
| Installation | DIN Track | | | |
| Communications power supply current consumption | 120 mA max. for 24-VDC power supply voltage 140 mA max. for 14-VDC power supply voltage | | 135 mA max. for 24-VDC power supply voltage 155 mA max. for 14-VDC power supply voltage | |
| Weight | 180 g max. | | | |

Input Section Specifications

| Item | Specification | | | |
|--------------------------------------|--|--|--|--|
| Model | CRT1-MD32S | CRT1-MD32S-1 | CRT1-MD32SH | CRT1-MD32SH-1 |
| I/O capacity | 16 inputs | | | |
| Internal I/O common | NPN | PNP | NPN | PNP |
| ON voltage | 10.5 VDC min. (between each input terminal and the V terminal) | 10.5 VDC min. (between each input terminal and the G terminal) | 10.5 VDC min. (between each input terminal and the V terminal) | 10.5 VDC min. (between each input terminal and the G terminal) |
| OFF current | 1.0 mA max. | | | |
| Input current | At 24 VDC: 6.0 mA max./input At 11 VDC: 3.0 mA min./input | | | |
| ON delay | 1.5 ms max. | | | |
| OFF delay | 1.5 ms max. | | | |
| Power supply short-circuit detection | --- | | Operates at 50 mA/point min. | |
| Disconnection detection | --- | | Operates at 0.3 mA/point max. | |
| Number of circuits per common | 16 inputs/common | | | |
| Isolation method | Photocoupler | | | |
| Input indicator | LED (yellow) | | | |
| Power supply type | Network power supply | | | |
| Power short-circuit protection | Operates at 50 mA/point min. | | | |
| Current supplied to input devices | 50 mA/input | | | |

Output Section Specifications

| Item | Specification | | | |
|---|--|--|--|--|
| Model | CRT1-MD32S | CRT1-MD32S-1 | CRT1-MD32SH | CRT1-MD32SH-1 |
| I/O capacity | 16 outputs | | | |
| Internal I/O common | NPN | PNP | NPN | PNP |
| Rated output current | 0.5 A/output, 4 A/common | | | |
| Residual voltage | 1.2 V max. (0.5 A DC, between each output terminal and the G terminal) | 1.2 V max. (0.5 A DC, between each output terminal and the V terminal) | 1.2 V max. (0.5 A DC, between each output terminal and the G terminal) | 1.2 V max. (0.5 A DC, between each output terminal and the V terminal) |
| Leakage current | 0.1 mA max. | | | |
| ON delay | 0.5 ms max. | | | |
| OFF delay | 1.5 ms max. | | | |
| Load short-circuit detection | --- | | Supported. | |
| Disconnection detection | --- | | Operates at 3 mA/point max. (Does not operate at over 3 mA.) | |
| Number of circuits per common | 16 outputs/common | | | |
| Isolation method | Photocoupler | | | |
| Output indicators | LED (yellow) | | | |
| Power supply type | Multi-power supply | | | |
| Current supplied to output devices | 100 mA/output | | | |
| I/O power supply current consumption | 20 mA max. for 24-VDC power supply voltage | | 15 mA max. for 24-VDC power supply voltage | 60 mA max. for 24-VDC power supply voltage |
| Output handling for communications errors | Select either hold or clear from CX-Integrator. | | | |

Dimensions

(Unit: mm)

CRT1-ID16S (-1)
 CRT1-ID16SH (-1)

When a DCN4-TB4 Open Type Connectors Is Mounted

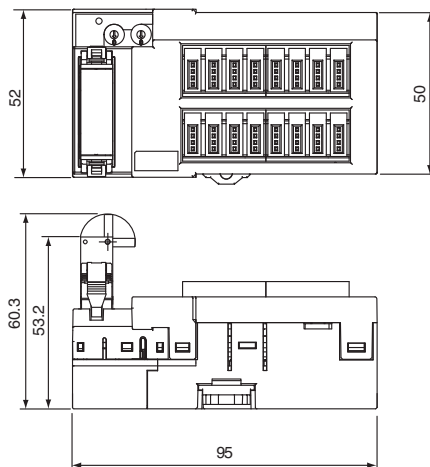

CRT1-MD16S (-1)
 CRT1-MD16SH (-1)
 CRT1-OD16S (-1)
 CRT1-OD16SH (-1)

When a DCN4-TB4 Open Type Connectors Is Mounted

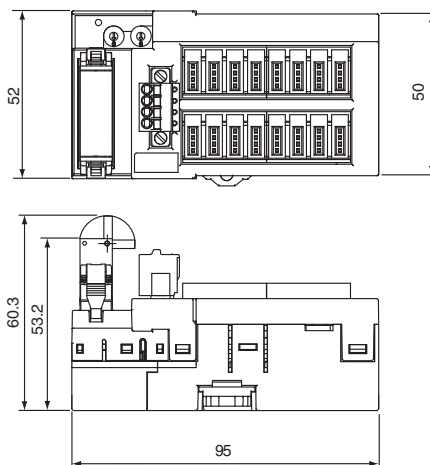

CRT1-ID32S (-1)
 CRT1-ID32SH (-1)

When a DCN4-TB4 Open Type Connectors Is Mounted

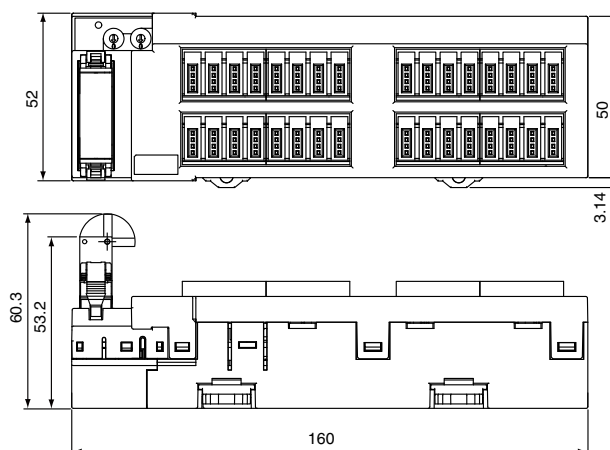

CRT1-OD32S (-1)
 CRT1-OD32SH (-1)

When a DCN4-TB4 Open Type Connectors Is Mounted

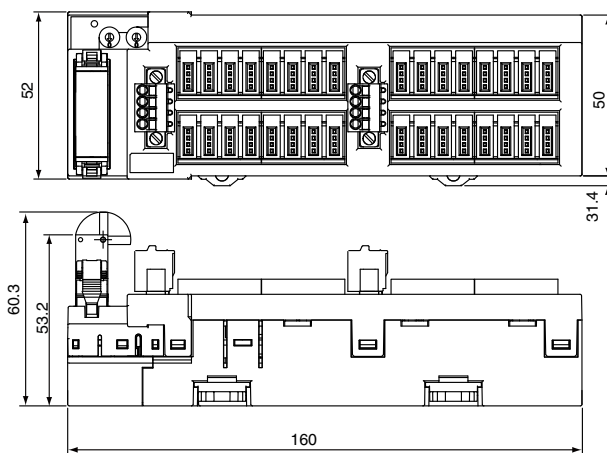

CRT1-MD32S (-1)
 CRT1-MD32SH (-1)

When a DCN4-TB4 Open Type Connectors Is Mounted

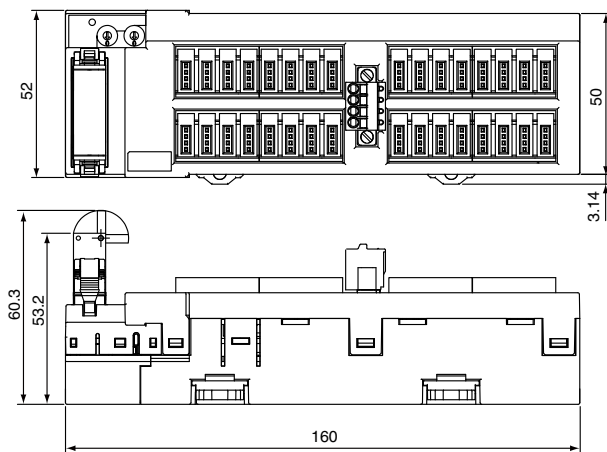

Digital I/O Slave Units with e-CON Connector (Vertical type)

CRT1-VID08S(-1)/VOD08S(-1)

A vertical slave unit of little wiring and size

Industrial standard e-CON connectors allow direct connection of the unit to sensing devices without use of terminal blocks. This minimizes requirement in installation space and wiring work.

- Industrial standard e-CON connectors require less wiring work.
- Connector interface of input and output sections can downsize the unit.
- Various data such as network status at start-up, equipment operation and deterioration can be provided.
- DIN tracks and metal fixtures allow flexible installation.



Ordering Information

| Name | Specifications | | | Model |
|--------------------|---|-----------|-----|---|
| e-CON Connectors * | Inputs | 8 inputs | NPN | Without Short-circuit and Disconnected Line Detection |
| | | | PNP | |
| | Outputs | 8 outputs | NPN | |
| | | | PNP | |
| Mounting Bracket | Unit with e-CON Connectors CRT1-V□D08S(-1) | | | CRT1-ATT02 |

* These Units are also available with a DCN-TB4 Terminal Conversion Adapter included in the package. Add "(-B)" to the end of the model number to receive the Adapter as well.

Slave External I/O Connections in the appendix for applicable connectors.

Performance Specifications

For Basic Performance Specifications of Slave Units, refer to page 30.

Input Section Specifications

| Item | Specification | |
|---|--|--|
| Model | CRT1-VID08S | CRT1-VID08S-1 |
| I/O capacity | 8 inputs | |
| Internal I/O common | NPN | PNP |
| ON voltage | 10.5 VDC min. (between each input terminal and the V terminal) | 10.5 VDC min. (between each input terminal and the G terminal) |
| OFF voltage | 5 VDC max. (between each input terminal and the V terminal) | 5 VDC max. (between each input terminal and the G terminal) |
| OFF current | 1.0 mA max. | |
| Input current | At 24 VDC: 6.0 mA max./input At 11 VDC: 3.0 mA min./input | |
| ON delay | 1.5 ms max. | |
| OFF delay | 1.5 ms max. | |
| Number of circuits per common | 8 inputs/common | |
| Isolation method | Photocoupler | |
| Input indicator | LED (yellow) | |
| Installation | DIN Track or Mounting Bracket | |
| Power supply type | Network power supply | |
| Power short-circuit protection | Operates at 50 mA/point min. | |
| Current supplied to input devices | 50 mA/input | |
| Communications power supply current consumption | 35 mA max. for 24-VDC power supply voltage 50 mA max. for 14-VDC power supply voltage | |
| Weight | 80 g max. | |

Output Section Specifications

| Item | Specification | |
|---|--|--|
| Model | CRT1-VOD08S | CRT1-VOD08S-1 |
| I/O capacity | 8 outputs | |
| Internal I/O common | NPN | PNP |
| Rated output current | 0.3 A/output, 2 A/common | |
| Residual voltage | 1.2 V max. (0.3 A DC, between each output terminal and the G terminal) | 1.2 V max. (0.3 A DC, between each output terminal and the V terminal) |
| Leakage current | 0.1 mA max. | |
| ON delay | 0.5 ms max. | |
| OFF delay | 1.5 ms max. | |
| Number of circuits per common | 8 outputs/common | |
| Isolation method | Photocoupler | |
| Output indicators | LED (yellow) | |
| Installation | DIN Track or Mounting Bracket | |
| Power supply type | Multi-power supply | |
| Current supplied to output devices | 100 mA/output | |
| Communications power supply current consumption | 40 mA max. for 24-VDC power supply voltage 60 mA max. for 14-VDC power supply voltage | |
| I/O power supply current consumption | 15 mA max. for 24-VDC power supply voltage | |
| Output handling for communications errors | Select either hold or clear from CX-Integrator. | |
| Weight | 80 g max. | |

Dimensions

(Unit: mm)

CRT1-VID08S (-1)
CRT1-VOD08S (-1)

When a DCN4-TB4 Open Type Connectors Is Mounted

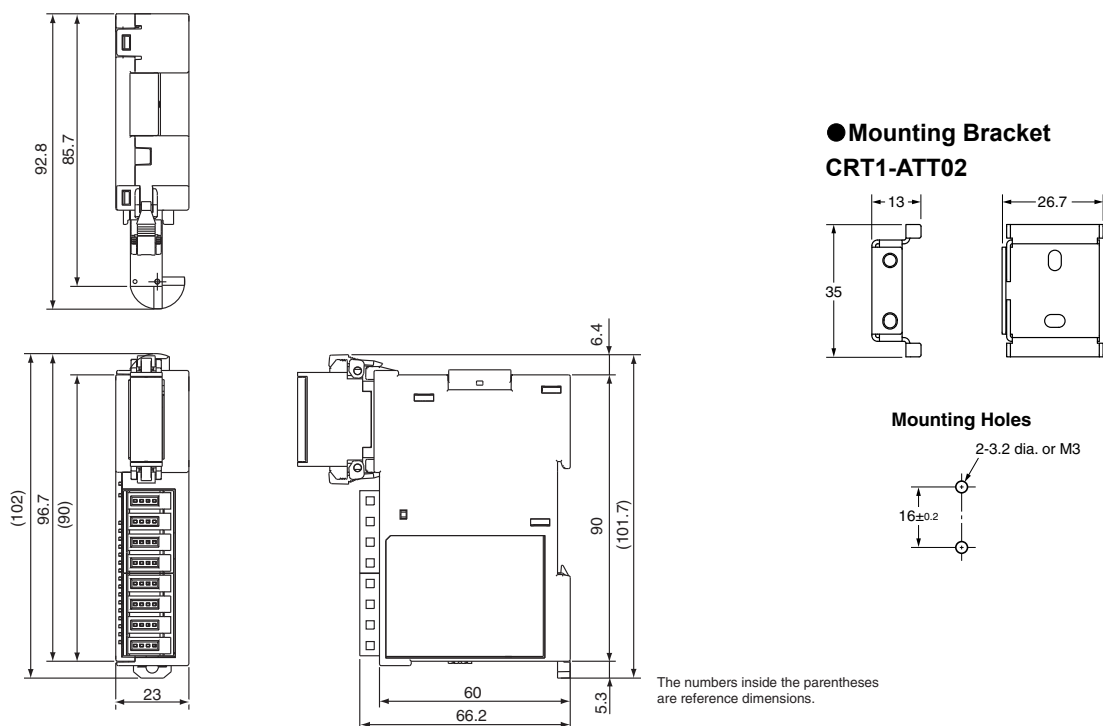

Digital I/O Slave Units with MIL Connector (Vertical type)

CRT1-VID16ML(-1)/VOD16ML(-1)

Thinnest in the industry!

Ultimately little space and wiring are required.

MIL connectors expand I/O interface options to include direct connection to actuators and to terminal block conversion units.

- Super thin width of 15 mm could downsize the control panel.
- Connector interface between the communications unit and the I/O units can reduce start-up time and raise maintenance ability.
- Various maintenance data such as operation status and deterioration of equipment can be collected to improve productivity.
- DIN tracks and metal fixtures allow flexible installation.
- Wide range of connection styles are available including direct connection to actuators and to terminal block conversion units.



Ordering Information

| Name | Specifications | | | Model |
|------------------|--------------------------|------------|-----|----------------|
| MIL Connector * | Inputs | 16 inputs | NPN | CRT1-VID16ML |
| | | | PNP | CRT1-VID16ML-1 |
| | Outputs | 16 outputs | NPN | CRT1-VOD16ML |
| | | | PNP | CRT1-VOD16ML-1 |
| Mounting Bracket | Unit with MIL Connectors | | | CRT1-ATT01 |

* These Units are also available with a DCN-TB4 Terminal Conversion Adapter included in the package. Add "(-B)" to the end of the model number to receive the Adapter as well.

Slave External I/O Connections in the appendix for applicable connectors.

Performance Specifications

For Basic Performance Specifications of Slave Units, refer to page 30.

Input Section Specifications

| Item | Specification | |
|---|--|---|
| Model | CRT1-VID16ML | CRT1-VID16ML-1 |
| I/O capacity | 16 inputs | |
| Internal I/O common | NPN | PNP |
| ON voltage | 17 VDC min. (between each input terminal and the V terminal) | 17 VDC min. (between each input terminal and the G terminal) |
| OFF voltage | 5 VDC max. (between each input terminal and the V terminal) | 5 VDC max. (between each input terminal and the G terminal) |
| OFF current | 1.0 mA max. | |
| Input current | At 24 VDC: 6.0 mA max./input At 17 VDC: 3.0 mA min./input | |
| ON delay | 1.5 ms max. | |
| OFF delay | 1.5 ms max. | |
| Number of circuits per common | 16 inputs/common | |
| Isolation method | Photocoupler | |
| Input indicator | LED (yellow) | |
| Installation | DIN Track or Mounting Bracket | |
| Power supply type | Multi-power supply | |
| Communications power supply current consumption | 40 mA max. for 24-VDC power supply voltage 60 mA max. for 14-VDC power supply voltage | |
| I/O power supply current consumption | 5 mA max. for 24-VDC power supply voltage | |
| Weight | 80 g max. | |

Output Section Specifications

| Item | Specification | |
|---|--|--|
| Model | CRT1-VOD16ML | CRT1-VOD16ML-1 |
| I/O capacity | 16 outputs | |
| Internal I/O common | NPN | PNP |
| Rated output current | 0.3 A/output, 2 A/common * | |
| Residual voltage | 1.2 V max. (0.3 A DC, between each output terminal and the G terminal) | 1.2 V max. (0.3 A DC, between each output terminal and the V terminal) |
| Leakage current | 0.1 mA max. | |
| ON delay | 0.5 ms max. | |
| OFF delay | 1.5 ms max. | |
| Number of circuits per common | 16 outputs/common | |
| Isolation method | Photocoupler | |
| Output indicators | LED (yellow) | |
| Installation | DIN Track or Mounting Bracket | |
| Power supply type | Multi-power supply | |
| Communications power supply current consumption | 45 mA max. for 24-VDC power supply voltage 65 mA max. for 14-VDC power supply voltage | |
| I/O power supply current consumption | 15 mA max. for 24-VDC power supply voltage | |
| Output handling for communications errors | Select either hold or clear from CX-Integrator. | |
| Weight | 70 g max. | |

* Do not use a total external load current of more than 2 A, and do not use more than 1 A per V terminal or G terminal.

Dimensions

(Unit: mm)

CRT1-VID16ML (-1)
CRT1-VOD16ML (-1)

When a DCN4-TB4 Open Type Connectors Is Mounted

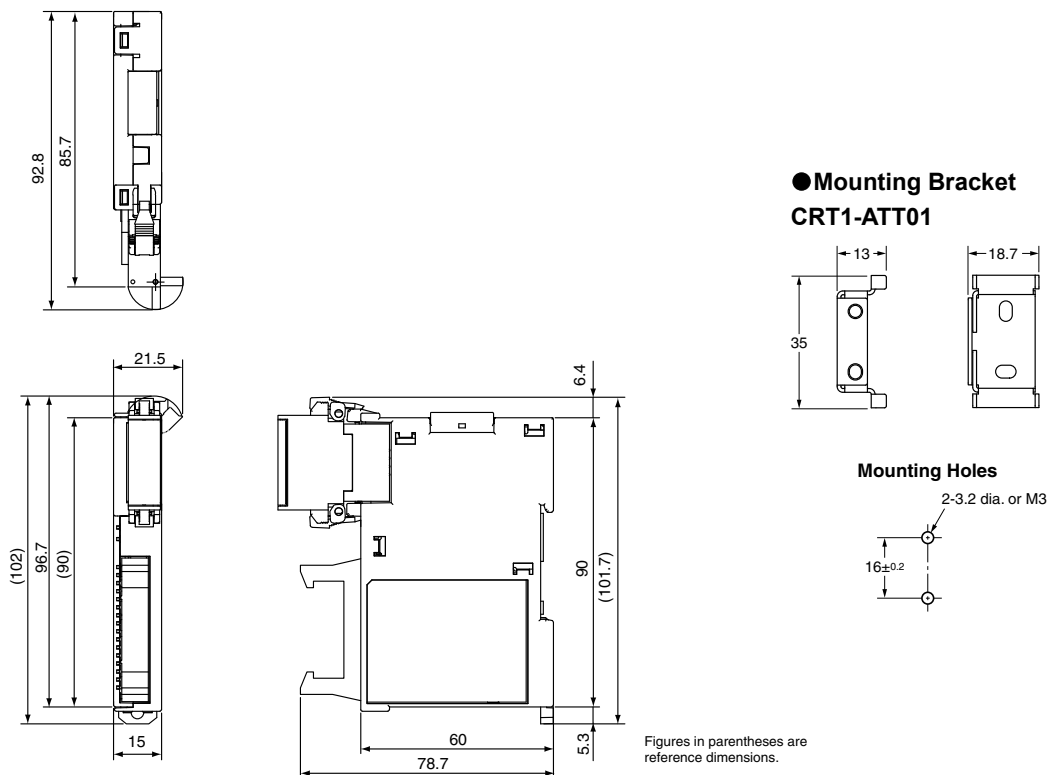

Digital I/O Slave Units with MIL Connector (Vertical type)

CRT1-VID32ML(-1)/VOD32ML(-1)/VMD32ML(-1)

Aggregation of multi-I/O points!

A compact and little wiring slave with 32 points and MIL connector

MIL connectors expand I/O interface options to include collective connection of multiple I/O points to boards as well as direct connection to actuators via branching cables.

- Super compact slave with 32 points and MIL connector (35 mm wide x 60 mm deep x 80 mm high)
- Aggregation of multi I/O points enables connection to actuators and boards.
- Connector interface between the communications unit and the I/O units greatly reduces wiring man-hour.
- DIN tracks and metal fixtures allow flexible installation.
- Various maintenance data such as operation status and deterioration of equipment can be collected to improve productivity.



Ordering Information

| Name | Specifications | | | Model |
|------------------|--|--------------------------|-----|----------------|
| MIL Connector * | Inputs | 32 inputs | NPN | CRT1-VID32ML |
| | | | PNP | CRT1-VID32ML-1 |
| | Outputs | 32 outputs | NPN | CRT1-VOD32ML |
| | | | PNP | CRT1-VOD32ML-1 |
| | Inputs/ Outputs | 16 inputs/ 16 outputs | NPN | CRT1-VMD32ML |
| | | | PNP | CRT1-VMD32ML-1 |
| Mounting Bracket | Unit with MIL Connectors CRT1-V□D32ML(-1) | | | SRT1-ATT02 |

* These Units are also available with a DCN-TB4 Terminal Conversion Adapter included in the package. Add "(-B)" to the end of the model number to receive the Adapter as well.

Slave External I/O Connections in the appendix for applicable connectors.

Performance Specifications

For Basic Performance Specifications of Slave Units, refer to page 30.

Input Section Specifications

| Item | Specification | |
|---|--|---|
| Model | CRT1-VID32ML | CRT1-VID32ML-1 |
| I/O capacity | 32 inputs | |
| Internal I/O common | NPN | PNP |
| ON voltage | 17 VDC min. (between each input terminal and the V terminal) | 17 VDC min. (between each input terminal and the G terminal) |
| OFF voltage | 5 VDC max. (between each input terminal and the V terminal) | 5 VDC max. (between each input terminal and the G terminal) |
| OFF current | 1.0 mA max. | |
| Input current | At 24 VDC: 6.0 mA max./input At 17 VDC: 3.0 mA min./input | |
| ON delay | 1.5 ms max. | |
| OFF delay | 1.5 ms max. | |
| Number of circuits per common | 32 inputs/common | |
| Number of simultaneous inputs | 32 max. * | |
| Isolation method | Photocoupler | |
| Input indicator | LED (yellow) | |
| Installation | DIN Track or Mounting Bracket | |
| Power supply type | Multi-power supply | |
| Communications power supply current consumption | 40 mA max. for 24-VDC power supply voltage 60 mA max. for 14-VDC power supply voltage | |
| I/O power supply current consumption | 2 mA max. for 24-VDC power supply voltage | |
| Weight | 120 g max. | |

* When Units Are Mounted Facing Upwards:

If 16 points may be turned ON simultaneously, the distance between the Units must be restricted depending on the ambient operating temperature, as shown in the following graph. For example, when the ambient operating temperature is 55°C, a space of at least 10 mm is required between Units.

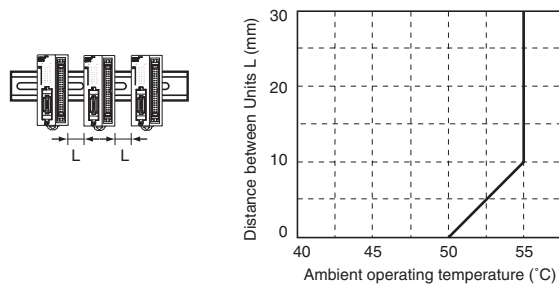

Output Section Specifications

| Item | Specification | |
|---|--|--|
| Model | CRT1-VOD32ML | CRT1-VOD32ML-1 |
| I/O capacity | 32 outputs | |
| Internal I/O common | NPN | PNP |
| Rated output current | 0.3 A/output, 4 A/common * | |
| Residual voltage | 1.2 V max. (0.3 A DC, between each output terminal and the G terminal) | 1.2 V max. (0.3 A DC, between each output terminal and the V terminal) |
| Leakage current | 0.1 mA max. | |
| ON delay | 0.5 ms max. | |
| OFF delay | 1.5 ms max. | |
| Number of circuits per common | 32 outputs/common | |
| Isolation method | Photocoupler | |
| Output indicators | LED (yellow) | |
| Installation | DIN Track or Mounting Bracket | |
| Power supply type | Multi-power supply | |
| Communications power supply current consumption | 50 mA max. for 24-VDC power supply voltage 80 mA max. for 14-VDC power supply voltage | |
| I/O power supply current consumption | 6.5 mA max. for 24-VDC power supply voltage | |
| Output handling for communications errors | Select either hold or clear from CX-Integrator. | |
| Weight | 100 g max. | |

* Do not use a total external load current of more than 4 A, and do not use more than 1 A per V terminal or G terminal.

Input and Output Section Specifications

● Sixteen-point Input and Sixteen-point Output Units

Common Specifications

| Item | Specification | |
|---|--|----------------|
| Model | CRT1-VMD32ML | CRT1-VMD32ML-1 |
| Installation | DIN Track or Mounting Bracket | |
| Communications power supply current consumption | 45 mA max. for 24-VDC power supply voltage 70 mA max. for 14-VDC power supply voltage | |
| Weight | 110 g max. | |

Input Section Specifications

| Item | Specification | |
|--------------------------------------|--|--|
| Model | CRT1-VMD32ML | CRT1-VMD32ML-1 |
| I/O capacity | 16 inputs | |
| Internal I/O common | NPN | PNP |
| ON voltage | 17 VDC min. (between each input terminal and the V terminal) | 17 VDC min. (between each input terminal and the G terminal) |
| OFF voltage | 5 VDC min. (between each input terminal and the V terminal) | 5 VDC min. (between each input terminal and the G terminal) |
| OFF current | 1.0 mA max. | |
| Input current | At 24 VDC: 6.0 mA max./input At 17 VDC: 3.0 mA min./input | |
| ON delay | 1.5 ms max. | |
| OFF delay | 1.5 ms max. | |
| Number of circuits per common | 16 inputs/common | |
| Number of simultaneous inputs | 16 max. * | |
| Isolation method | Photocoupler | |
| Input indicator | LED (yellow) | |
| Power supply type | Multi-power supply | |
| I/O power supply current consumption | 2 mA max. | |

* When Slave Units are mounted facing upwards, and 16 inputs may all turn ON, leave the specified distance between Units according to the ambient temperature.

Output Section Specifications

| Item | Specification | |
|---|--|--|
| Model | CRT1-VMD32ML | CRT1-VMD32ML-1 |
| I/O capacity | 16 outputs | |
| Internal I/O common | NPN | PNP |
| Rated output current | 0.3 A/output, 2 A/common * | |
| Residual voltage | 1.2 V max. (0.3 A DC, between each output terminal and the G terminal) | 1.2 V max. (0.3 A DC, between each output terminal and the V terminal) |
| Leakage current | 0.1 mA max. | |
| ON delay | 0.5 ms max. | |
| OFF delay | 1.5 ms max. | |
| Number of circuits per common | 16 outputs/common | |
| Isolation method | Photocoupler | |
| Output indicators | LED (yellow) | |
| Power supply type | Multi-power supply | |
| I/O power supply current consumption | 6.5 mA max. for 24-VDC power supply voltage | |
| Output handling for communications errors | Select either hold or clear from CX-Integrator. | |

* Do not use a total external load current of more than 2 A, and do not use more than 1 A per V terminal or G terminal.

Dimensions

(Unit: mm)

- CRT1-VID32ML (-1)
- CRT1-VOD32ML (-1)
- CRT1-VMD32ML (-1)

When a DCN4-TB4 Open Type Connectors Is Mounted

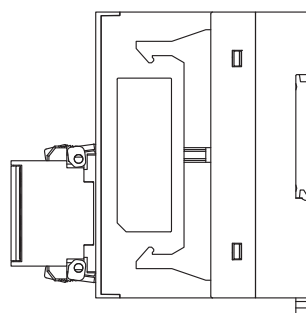
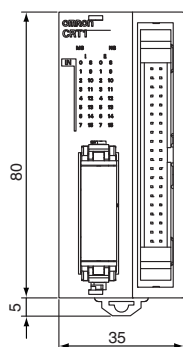
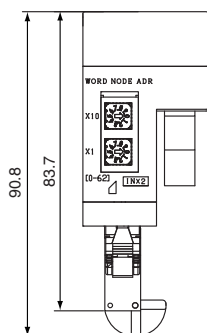

**● Mounting Bracket
SRT2-ATT02**

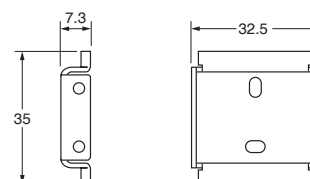

Mounting Holes

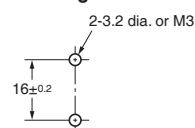

Digital I/O Slaves Units with Clamp Terminals

CRT1-□D08SL(-1)/□D16SL(-1)

Screw-less Terminal Wiring Further Reduces Wiring Work and Saves Labor at the Production Site.

- Screw-less (M3) design reduces the need for extra tightening.
- Removable terminal block gives powerful support to maintenance work.
- One-step wiring. Wire simply by inserting the ferrules.
- Applicable wire: AWG24 to AWG16 (cross-section: 0.2 to 1.25 mm²)

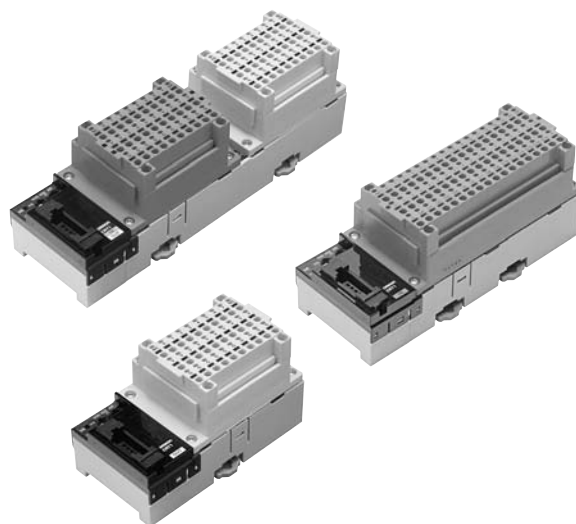

Ordering Information

| Name | Specifications | | Model | |
|--------------------|------------------------|------------|---------------|---------------|
| Clamp Terminals | Inputs | 8 inputs | NPN | CRT1-ID08SL |
| | | | PNP | CRT1-ID08SL-1 |
| | Outputs | 8 outputs | NPN | CRT1-OD08SL |
| | | | PNP | CRT1-OD08SL-1 |
| | Inputs | 16 inputs | NPN | CRT1-ID16SL |
| | | | PNP | CRT1-ID16SL-1 |
| | Outputs | 16 outputs | NPN | CRT1-OD16SL |
| | | | PNP | CRT1-OD16SL-1 |
| Inputs/ Outputs | 8 inputs/ 8 outputs | NPN | CRT1-MD16SL | |
| | | PNP | CRT1-MD16SL-1 | |

Slave External I/O Connections in the appendix for applicable ferrules.

Performance Specifications

For Basic Performance Specifications of Slave Units, refer to page 30.

Input Section Specifications

● Eight-point Input Units

| Item | Specification | |
|---|--|---|
| | CRT1-ID08SL | CRT1-ID08SL-1 |
| Model | CRT1-ID08SL | CRT1-ID08SL-1 |
| I/O capacity | 8 inputs | |
| Internal I/O common | NPN | PNP |
| ON voltage | 15 VDC min. (between each input terminal and the V terminal) | 15 VDC min. (between each input terminal and the G terminal) |
| OFF voltage | 5 VDC max. (between each input terminal and the V terminal) | 5 VDC max. (between each input terminal and the G terminal) |
| OFF current | 1 mA max. | |
| Input current | At 24 VDC: 6.0 mA max./input At 17 VDC: 3.0 mA min./input | |
| ON delay | 1.5 ms max. | |
| OFF delay | 1.5 ms max. | |
| Number of circuits per common | 8 inputs/common | |
| Isolation method | Photocoupler | |
| Input indicator | LED (yellow) | |
| Installation | DIN Track | |
| Power supply type | Multi-power supply | |
| Current supplied to input devices | 100 mA/input | |
| Communications power supply current consumption | 30 mA max. for 24-VDC power supply voltage 50 mA max. for 14-VDC power supply voltage | |
| I/O power supply current consumption | 15 mA max. for 24-VDC power supply voltage | |
| Weight | 170 g max. | |

● Sixteen-point Input Units

| Item | Specification | |
|---|--|---|
| | CRT1-ID16SL | CRT1-ID16SL-1 |
| Model | CRT1-ID16SL | CRT1-ID16SL-1 |
| I/O capacity | 16 inputs | |
| Internal I/O common | NPN | PNP |
| ON voltage | 15 VDC min. (between each input terminal and the V terminal) | 15 VDC min. (between each input terminal and the G terminal) |
| OFF voltage | 5 VDC max. (between each input terminal and the V terminal) | 5 VDC max. (between each input terminal and the G terminal) |
| OFF current | 1.0 mA max. | |
| Input current | At 24 VDC: 6.0 mA max./input At 17 VDC: 3.0 mA max./input | |
| ON delay | 1.5 ms max. | |
| OFF delay | 1.5 ms max. | |
| Number of circuits per common | 16 inputs/common | |
| Isolation method | Photocoupler | |
| Input indicator | LED (yellow) | |
| Installation | DIN Track mounting | |
| Power supply type | Multi-power supply | |
| Communications power supply current consumption | 35 mA max. for 24-VDC power supply voltage 55 mA max. for 14-VDC power supply voltage | |
| I/O power supply current consumption | 15 mA max. for 24-VDC power supply voltage | |
| Weight | 250 g max. | |

Output Section Specifications

● Eight-point Output Units

| Item | Specification | |
|---|--|--|
| | CRT1-OD08SL | CRT1-OD08SL-1 |
| Model | CRT1-OD08SL | CRT1-OD08SL-1 |
| I/O capacity | 8 outputs | |
| Internal I/O common | NPN | PNP |
| Rated output current | 0.5 A/output, 2 A/common | |
| Residual voltage | 1.2 V max. (0.5 A DC, between each output terminal and the G terminal) | 1.2 V max. (0.5 A DC, between each output terminal and the V terminal) |
| Leakage current | 0.1 mA max. | |
| ON delay | 0.5 ms max. | |
| OFF delay | 1.5 ms max. | |
| Number of circuits per common | 8 outputs/common | |
| Isolation method | Photocoupler | |
| Output indicators | LED (yellow) | |
| Installation | DIN Track | |
| Power supply type | Multi-power supply | |
| Current supplied to output devices | 100 mA/output | |
| Communications power supply current consumption | 35 mA max. for 24-VDC power supply voltage 55 mA max. for 14-VDC power supply voltage | |
| I/O power supply current consumption | 25 mA max. for 24-VDC power supply voltage | |
| Output handling for communications errors | Select either hold or clear from CX-Integrator. | |
| Weight | 170 g max. | |

● Sixteen-point Output Unit

| Item | Specification | |
|---|--|--|
| | CRT1-OD16SL | CRT1-OD16SL-1 |
| Model | CRT1-OD16SL | CRT1-OD16SL-1 |
| I/O capacity | 16 outputs | |
| Internal I/O common | NPN | PNP |
| Rated output current | 0.5 A/output, 4 A/common | |
| Residual voltage | 1.2 V max. (0.5 A DC, between each output terminal and the G terminal) | 1.2 V max. (0.5 A DC, between each output terminal and the V terminal) |
| Leakage current | 0.1 mA max. | |
| ON delay | 0.5 ms max. | |
| OFF delay | 1.5 ms max. | |
| Number of circuits per common | 16 outputs/common | |
| Isolation method | Photocoupler | |
| Output indicators | LED (yellow) | |
| Installation | DIN Track mounting | |
| Power supply type | Multi-power supply | |
| Communications power supply current consumption | 35 mA max. for 24-VDC power supply voltage 60 mA max. for 14-VDC power supply voltage | |
| I/O power supply current consumption | 30 mA max. for 24-VDC power supply voltage | |
| Output handling for communications errors | Hold or clear can be selected. (CompoNet Support Software) | |
| Weight | 250 g max. | |

Input and Output Section Specifications

● Eight-point Input and Eight-point Output Units

Common Specifications

| Item | Specification | |
|---|--|---------------|
| Model | CRT1-MD16SL | CRT1-MD16SL-1 |
| Installation | DIN Track | |
| Communications power supply current consumption | 35 mA max. for 24-VDC power supply voltage 60 mA max. for 14-VDC power supply voltage | |
| Weight | 290 g max. | |

Input Specifications

| Item | Specification | |
|--------------------------------------|---|---|
| Model | CRT1-MD16SL | CRT1-MD16SL-1 |
| I/O capacity | 8 inputs | |
| Internal I/O common | NPN | PNP |
| ON voltage | 15 VDC min. (between each input terminal and the V terminal) | 15 VDC min. (between each input terminal and the G terminal) |
| OFF voltage | 5 VDC min. (between each input terminal and the V terminal) | 5 VDC min. (between each input terminal and the G terminal) |
| OFF current | 1.0 mA max. | |
| Input current | At 24 VDC: 6.0 mA max./input At 11 VDC: 3.0 mA min./input | |
| ON delay | 1.5 ms max. | |
| OFF delay | 1.5 ms max. | |
| Number of circuits per common | 8 inputs/common | |
| Isolation method | Photocoupler | |
| Input indicator | LED (yellow) | |
| Power supply type | Multi-power supply | |
| Current supplied to input devices | 100 mA/input | |
| I/O power supply current consumption | 15 mA max. for 24-VDC power supply voltage | |

Output Specifications

| Item | Specification | |
|---|--|--|
| Model | CRT1-MD16SL | CRT1-MD16SL-1 |
| I/O capacity | 8 outputs | |
| Internal I/O common | NPN | PNP |
| Rated output current | 0.5 A/output, 2 A/common | |
| Residual voltage | 1.2 V max. (0.5 A DC, between each output terminal and the G terminal) | 1.2 V max. (0.5 A DC, between each output terminal and the V terminal) |
| Leakage current | 0.1 mA max. | |
| ON delay | 0.5 ms max. | |
| OFF delay | 1.5 ms max. | |
| Number of circuits per common | 8 outputs/common | |
| Isolation method | Photocoupler | |
| Output indicators | LED (yellow) | |
| Power supply type | Multi-power supply | |
| Current supplied to output devices | 100 mA/output | |
| I/O power supply current consumption | 25 mA max. for 24-VDC power supply voltage | |
| Output handling for communications errors | Select either hold or clear from CX-Integrator. | |

Dimensions

(Unit: mm)

CRT1-ID08SL (-1)
 CRT1-OD08SL (-1)

When a DCN4-TB4 Open Type Connectors Is Mounted

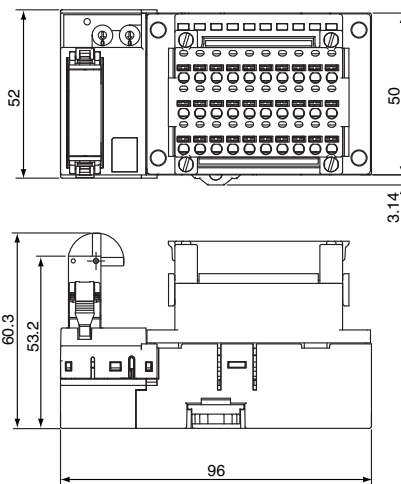

CRT1-ID16SL (-1)
 CRT1-OD16SL (-1)

When a DCN4-TB4 Open Type Connectors Is Mounted

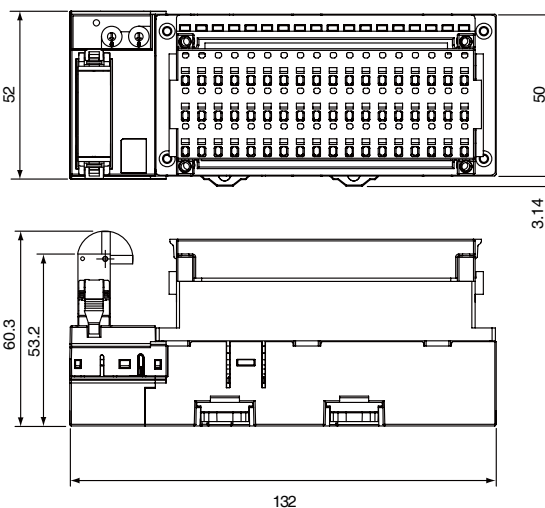

CRT1-MD16SL (-1)

When a DCN4-TB4 Open Type Connectors Is Mounted

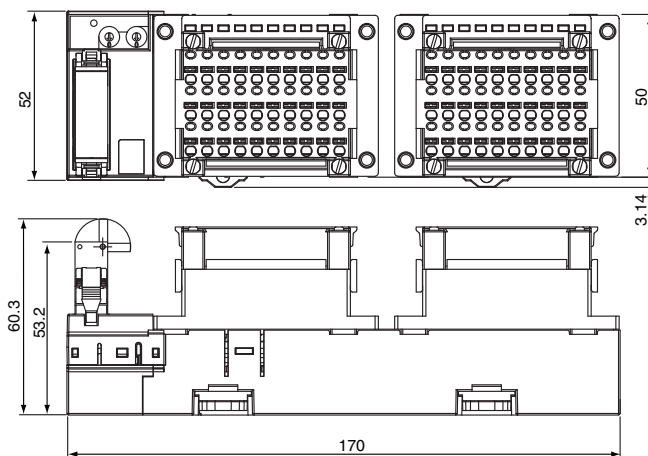

Analog I/O Slave Units

CRT1-AD04/DA02

Convert to Smart for Smarter Processing! Simple and Intelligent Analog I/O Slaves

In addition to analog data input and output, Analog I/O Slave Units can use a variety of functions internally, such as scaling, that previously required processing in ladder programming at the host PLC.

- Analog processing equivalent to digital panel meters is supported, such as with the scaling function.
- Use deviation and cumulative counter functions for analog calculations, such as for equipment error prediction and flow rate applications.
- The user adjustment function can be used to compensate offsets in inputs or outputs.
- Easily change the input or output range with a switch setting.

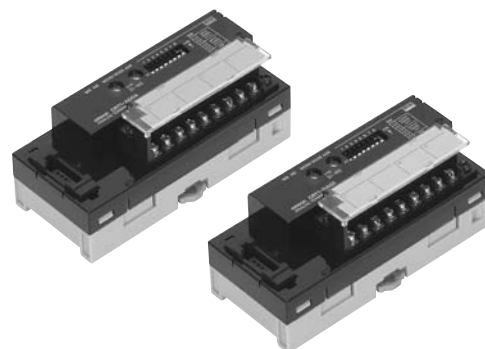

Ordering Information

| Name | Specifications | | Model |
|--------------------------|----------------|-----------|-----------|
| Analog I/O Slave Units * | Analog inputs | 4 inputs | CRT1-AD04 |
| | Analog outputs | 2 outputs | CRT1-DA02 |

* These Units are also available with a DCN-TB4 Terminal Conversion Adapter included in the package. Add "(-B)" to the end of the model number to receive the Adapter as well.

Performance Specifications

For Basic Performance Specifications of Slave Units, refer to page 30.

Input Section Specifications

| Item | Specification | | |
|--|---|--------------------------|----------|
| | Voltage input | Current input | |
| Model | CRT1-AD04 | | |
| Input signal ranges | 0 to 5 V 1 to 5 V 0 to 10 V -10 to 10 V | 0 to 20 mA 4 to 20 mA | |
| Maximum signal input | ±15 V | ±30 mA | |
| Input impedance | 1 M Ω min. | Approx. 250 Ω | |
| Resolution | 1/6,000 (full scale) | | |
| Overall accuracy | 25°C | ±0.3% FS | ±0.4% FS |
| | -10 to 55°C | ±0.6% FS | ±0.8% FS |
| Conversion cycle | 1 ms/1 points | | |
| AD conversion data | -10 to 10 V range: F448 to 0BB8 hex full scale (-3,000 to 3,000) Other ranges: 0000 to 1770 hex full scale (0 to 6,000) AD conversion range: ±5% FS of the above data ranges. | | |
| Isolation method | Photocoupler isolation (between input and communications lines) No isolation between input signal wires | | |
| Mounting | DIN Track mounting | | |
| Power supply type | Multi-power supply | | |
| Communications power current consumption | 110 mA max. for 24-VDC power supply 175 mA max. for 14-VDC power supply | | |
| Weight | 153 g | | |

Output Section Specifications

| Item | Specification | | |
|---|---|--------------------------|------------|
| | Voltage output | Current output | |
| Model | CRT1-DA02 | | |
| Output signal ranges | 0 to 5 V 1 to 5 V 0 to 10 V -10 to 10 V | 0 to 20 mA 4 to 20 mA | |
| External output allowable load resistance | 1 kΩ min. | 600 Ω max. | |
| Resolution | 1/6,000 (full scale) | | |
| Overall accuracy | 25°C | ±0.4% FS | ±0.4% FS * |
| | -10 to 55°C | ±0.8% FS | ±0.8% FS * |
| Conversion cycle | 2 ms/2 points | | |
| DA conversion data | -10 to 10 V range: F448 to 0BB8 hex full scale (-3,000 to 3,000) Other ranges: 0000 to 1770 hex full scale (0 to 6,000) AD conversion range: ±5% FS of the above data ranges. | | |
| Isolation method | Photocoupler isolation (between output and communications lines) No isolation between output signal wires. | | |
| Mounting | DIN Track mounting | | |
| Power supply type | Multi-power supply | | |
| Communications power current consumption | 125 mA max. for 24-VDC power supply 205 mA max. for 14-VDC power supply | | |
| Weight | 155 g | | |

* The specified accuracy does not apply below 0.2 mA when using the 0 to 20 mA range.

Dimensions

(Unit: mm)

CRT1-AD04

CRT1-DA02

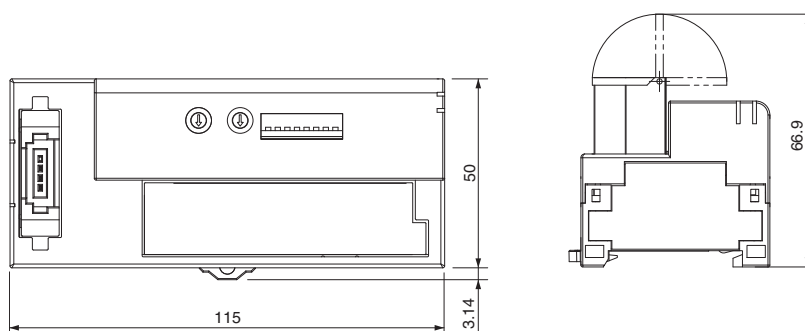

Analog I/O Slave Units with MIL Connectors/e-CON Connectors

CRT1-VAD04□□/-VDA02□□

Analog Slave Units with the Industry's Narrowest Width Help Save Space in Equipment and Panels

- The series includes Slave Units with a width of only 15 mm, the narrowest in the industry. Models with e-CON connectors boast a width of only 23 mm, making them the smallest in their class to save even more space.
- I/O interface wiring can be performed easily with either MIL connectors or e-CON connectors.
- Just make a few switch settings to complete Unit setup.
- Enhanced Smart functions in a slim body. Reduce your total cost of operation by collecting maintenance data by using only the Slave Unit.



Ordering Information

| Name | Specifications | | Model |
|----------------------|----------------------------|-----------|--------------|
| | Input/Output | Points | |
| MIL Connector Type | Analog Inputs | 4 inputs | CRT1-VAD04ML |
| | Analog Outputs | 2 outputs | CRT1-VDA02ML |
| e-CON Connector Type | Analog Inputs | 4 inputs | CRT1-VAD04S |
| | Analog Outputs | 2 outputs | CRT1-VDA02S |
| Mounting Bracket | Unit with MIL Connectors | | CRT1-ATT01 |
| | Unit with e-CON Connectors | | CRT1-ATT02 |

Slave External I/O Connections in the appendix for applicable connectors.

Performance Specifications

For Basic Performance Specifications of Slave Units, refer to page 30.

Input Section Specifications

● Four-point Analog Input Unit (with MIL Connectors) CRT1-VAD04ML

| Item | Specification | | |
|--|---|--------------------------|----------|
| | Voltage input | Current input | |
| Input signal ranges | 0 to 5 V 1 to 5 V 0 to 10 V -10 to 10 V | 0 to 20 mA 4 to 20 mA | |
| Maximum signal input | ±15 V | ±30 mA | |
| Input impedance | 1 MΩ min. | Approx. 250 Ω | |
| Resolution | 1/6,000 (full scale) | | |
| Overall accuracy | 25°C | ±0.3% FS | ±0.4% FS |
| | -10 to 55°C | ±0.6% FS | ±0.8% FS |
| Conversion cycle | 1 ms/ 1 point | | |
| AD conversion data | -10 to 10 V range: F448 to 0BB8 hex full scale (-3,000 to 3,000) Other ranges: 0000 to 1770 hex full scale (0 to 6,000) AD conversion range: ±5% FS of the above data ranges. | | |
| Isolation method | Photocoupler isolation (between input and communications lines) No isolation between input signal wires | | |
| Mounting | DIN Track mount or mount for Mounting Bracket | | |
| Power supply type | Multi-power supply | | |
| Communications power current consumption | 75 mA max. for 24-VDC power supply 115 mA max. for 14-VDC power supply | | |
| Weight | 70 g max. | | |

● Four-point Analog Input Unit (with e-CON Connectors) CRT1-VAD04S

| Item | Specification | | |
|--|---|--------------------------|----------|
| | Voltage input | Current input | |
| Input signal ranges | 0 to 5 V 1 to 5 V 0 to 10 V -10 to 10 V | 0 to 20 mA 4 to 20 mA | |
| Maximum signal input | ±15 V | ±30 mA | |
| Input impedance | 1 MΩ min. | Approx. 250 Ω | |
| Resolution | 1/6,000 (full scale) | | |
| Overall accuracy | 25°C | ±0.3% FS | ±0.4% FS |
| | -10 to 55°C | ±0.6% FS | ±0.8% FS |
| Conversion cycle | 1 ms/ 1 point | | |
| AD conversion data | -10 to 10 V range: F448 to 0BB8 hex full scale (-3,000 to 3,000) Other ranges: 0000 to 1770 hex full scale (0 to 6,000) AD conversion range: ±5% FS of the above data ranges. | | |
| Isolation method | Photocoupler isolation (between input and communications lines) No isolation between input signal wires | | |
| Mounting | DIN Track mount or mount for Mounting Bracket | | |
| Power supply type | Multi-power supply | | |
| Communications power current consumption | 75 mA max. for 24-VDC power supply 115 mA max. for 14-VDC power supply | | |
| Sensor power supply current * | Less than 200 mA (for each CH) | | |
| Weight | 85 g max. | | |

* In order to provide power to the sensor through the I/O connector, a 24-VDC power supply must be connected to the sensor power supply connector.

Output Section Specifications

● Two-point Analog Output Unit (with MIL Connectors) CRT1-VDA02ML

| Item | Specification | | |
|---|---|--------------------------|------------|
| | Voltage Output | Current Output | |
| Output signal ranges | 0 to 5 V 1 to 5 V 0 to 10 V -10 to 10 V | 0 to 20 mA 4 to 20 mA | |
| External output allowable load resistance | 1 kΩ min. | 600 Ω max. | |
| Resolution | 1/6,000 (full scale) | | |
| Overall accuracy | 25°C | ±0.4% FS | ±0.4% FS * |
| | -10 to 55°C | ±0.8% FS | ±0.8% FS * |
| Conversion cycle | 2 ms/ 2 points | | |
| DA conversion data | -10 to 10 V range: F448 to 0BB8 hex full scale (-3,000 to 3,000) Other ranges: 0000 to 1770 hex full scale (0 to 6,000) DA conversion range: ±5% FS of the above data ranges. | | |
| Isolation method | Photocoupler isolation (between output and communications lines) No isolation between output signal wires. | | |
| Mounting | DIN Track mount or mount for Mounting Bracket | | |
| Power supply type | Multi-power supply | | |
| Communications power current consumption | 105 mA max. for 24-VDC power supply 170 mA max. for 14-VDC power supply | | |
| Weight | 75 g max. | | |

* The specified accuracy does not apply below 0.2 mA when using the 0 to 20 mA range.

● Two-point Analog Output Unit (with e-CON Connectors) CRT1-VDA02S

| Item | Specification | | |
|---|---|--------------------------|------------|
| | Voltage Output | Current Output | |
| Output signal ranges | 0 to 5 V 1 to 5 V 0 to 10 V -10 to 10 V | 0 to 20 mA 4 to 20 mA | |
| External output allowable load resistance | 1 kΩ min. | 600 Ω max. | |
| Resolution | 1/6,000 (full scale) | | |
| Overall accuracy | 25°C | ±0.4% FS | ±0.4% FS * |
| | -10 to 55°C | ±0.8% FS | ±0.8% FS * |
| Conversion cycle | 2 ms/ 2 points | | |
| DA conversion data | -10 to 10 V range: F448 to 0BB8 hex full scale (-3,000 to 3,000) Other ranges: 0000 to 1770 hex full scale (0 to 6,000) DA conversion range: ±5% FS of the above data ranges. | | |
| Isolation method | Photocoupler isolation (between output and communications lines) No isolation between output signal wires. | | |
| Mounting | DIN Track mount or mount for Mounting Bracket | | |
| Power supply type | Multi-power supply | | |
| Communications power current consumption | 105 mA max. for 24-VDC power supply 170 mA max. for 14-VDC power supply | | |
| Weight | 85 g max. | | |

* The specified accuracy does not apply below 0.2 mA when using the 0 to 20 mA range.

Dimensions

● Four-point Analog Input Unit (with MIL Connectors) CRT1-VAD04ML

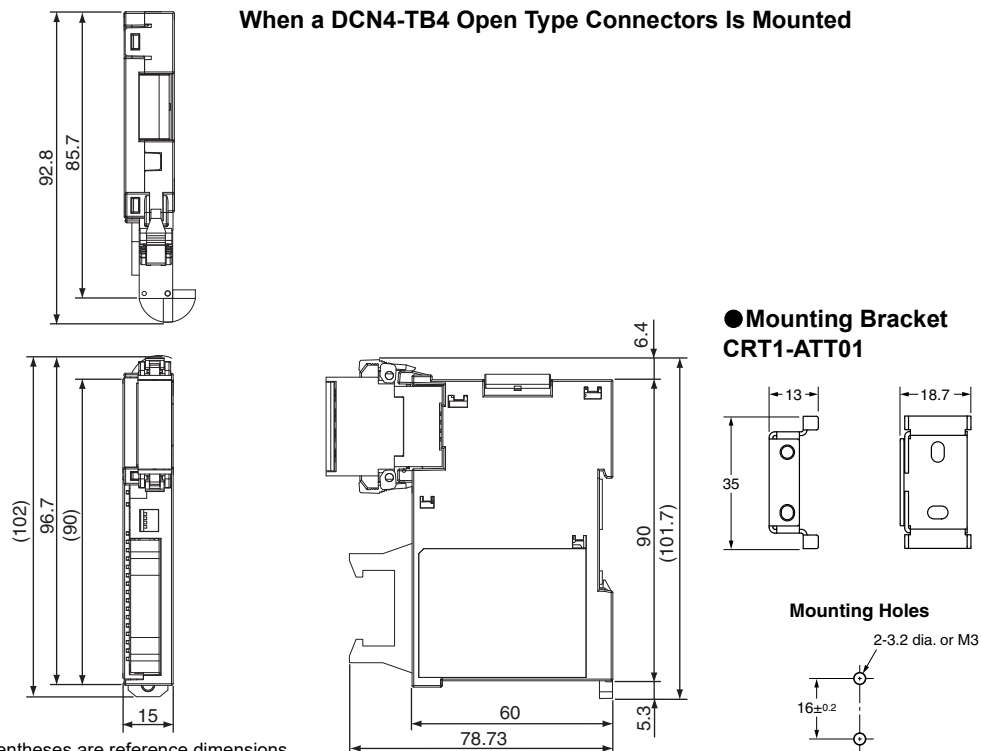

● Two-point Analog Output Unit (with MIL Connectors) CRT1-VDA02ML

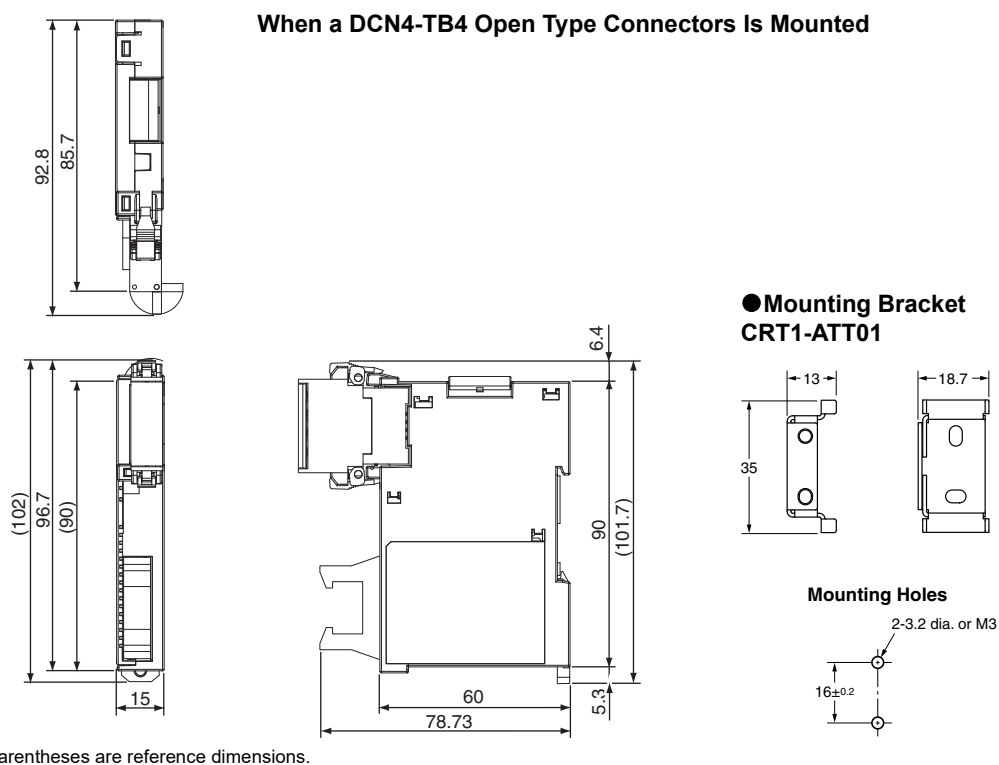

● Four-point Analog Input Unit (with e-CON Connectors)
CRT1-VAD04S

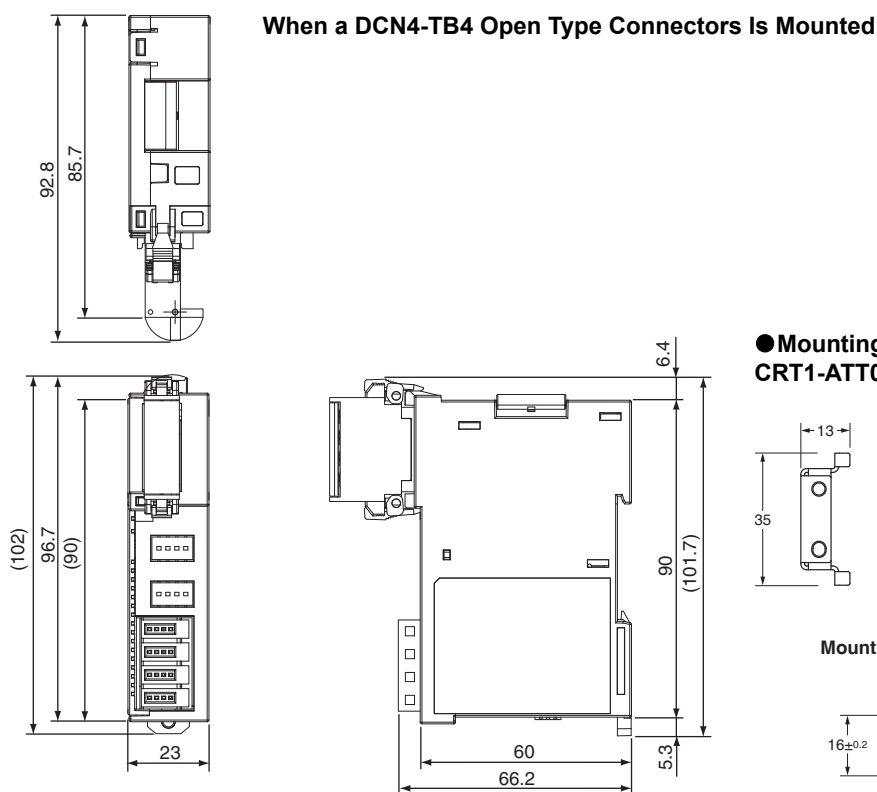

Note: The numbers inside the parentheses are reference dimensions.

● Two-point Analog Output Unit (with e-CON Connectors)
CRT1-VDA02S

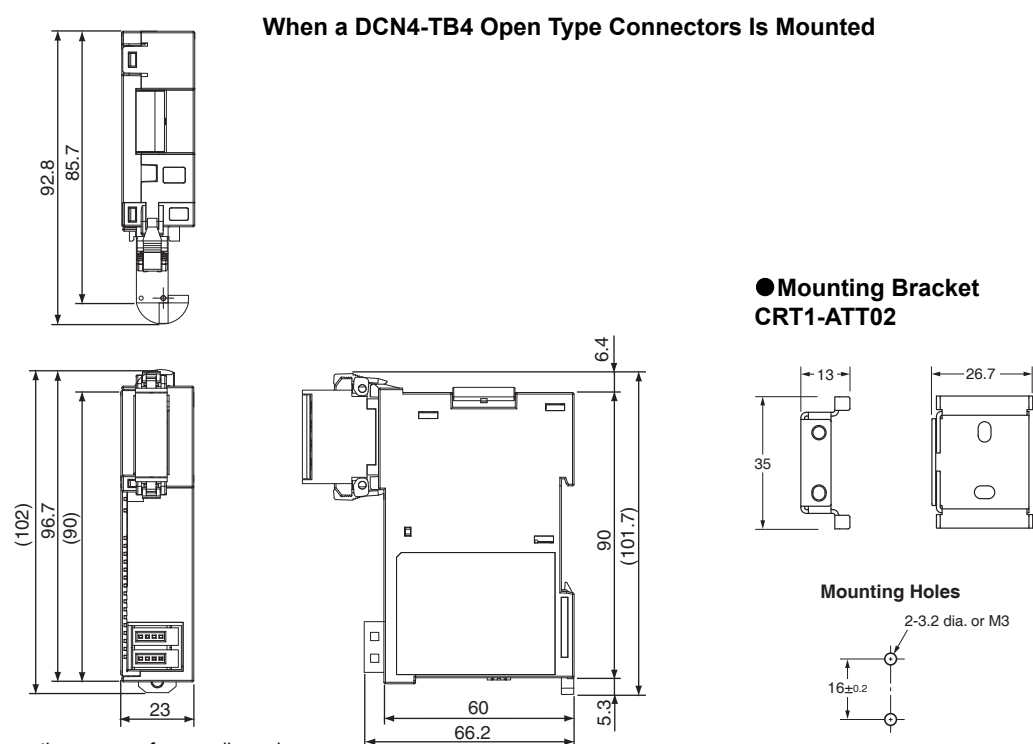

Note: The numbers inside the parentheses are reference dimensions.

Temperature Input Units

CRT1-TS04T/-TS04P

High-speed Transfer of Temperature Data with CompoNet.

Enhanced Smart Functions.

You can use either of two types of temperature input sensors: Thermocouple and resistance thermometer.

Each Unit provides four temperature inputs. Plus, the Units support scaling, comparators, and other data processing, reducing the processing load on the ladder program.

- Product lineup includes models with thermocouple inputs and models with resistance thermometer inputs.
- The node address, input types, and other settings can all be made using the switches on the Slave. (No Support Software is required.)
- Detachable terminal blocks enable easy maintenance without the need to remove wiring.
- Smart functions in the Slave reduce ladder programming and make maintenance easier. For example, scaling to convert input data to desired values, comparators to compare process values with preset upper and lower limits, and integrator to calculate the heat values of equipment or Sensors by from the temperature and measurement time.
- The Sensor open-circuit detection function reduces wiring errors.

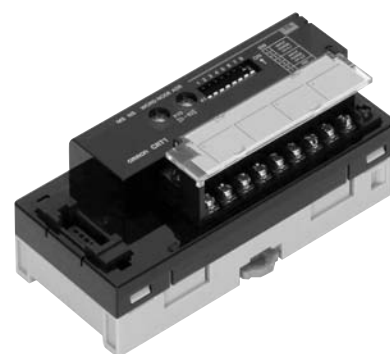

Ordering Information

| Name | Specifications | | | Model |
|------------------------|---------------------------------------|----------|---|------------|
| | Input/Output | Points | Specifications | |
| Temperature Input Unit | Thermocouple Input | 4 inputs | Switchable between R, S, K, J, T, E, B, N, L, U, W, and PL2 | CRT1-TS04T |
| | Platinum-resistance thermometer input | | PT100 (-200 to 850°C) PT100 (-200 to 200°C) | CRT1-TS04P |

Performance Specifications

For Basic Performance Specifications of Slave Units, refer to page 30.

Specifications

| Item | model | CRT1-TS04T | CRT1-TS04P | | | | | | | | | | | | | | |
|-------------------------------------|---|---|--|----------------|--------------------------|--------------------|---------|--------------------|---------------------|--------------------|---------------|----------------|---|---|-----|---|--|
| Input type | | Switchable between R, S, K, J, T, E, B, N, L, U, W, and PL2 When set with CX-Integrator: Input types can be set individually for each input. When set with DIP switch: The same input type setting applies to all 4 inputs. | Switchable between PT100 (-200 to 850°C) and PT100 (-200 to 200°C) When set with CX-Integrator: Input types can be set individually for each input. When set with DIP switch: The same input type setting applies to all 4 inputs. | | | | | | | | | | | | | | |
| Indicator accuracy | | (±0.3% of indication value or ±1°C, whichever is larger) ±1 digit max. Indicator Accuracy in Exceptional Cases <table border="1"> <thead> <tr> <th>Input type and temperature range</th> <th>Input accuracy</th> </tr> </thead> <tbody> <tr> <td>K, T, and N below -100°C</td> <td>±2°C ±1 digit max.</td> </tr> <tr> <td>U and L</td> <td>±2°C ±1 digit max.</td> </tr> <tr> <td>R and S below 200°C</td> <td>±3°C ±1 digit max.</td> </tr> <tr> <td>B below 400°C</td> <td>Not specified.</td> </tr> <tr> <td>W</td> <td>±0.3% of indication value or ±3°C (whichever is larger) ±1 digit max.</td> </tr> <tr> <td>PL2</td> <td>±0.3% of indication value or ±2°C (whichever is larger) ±1 digit max.</td> </tr> </tbody> </table> | Input type and temperature range | Input accuracy | K, T, and N below -100°C | ±2°C ±1 digit max. | U and L | ±2°C ±1 digit max. | R and S below 200°C | ±3°C ±1 digit max. | B below 400°C | Not specified. | W | ±0.3% of indication value or ±3°C (whichever is larger) ±1 digit max. | PL2 | ±0.3% of indication value or ±2°C (whichever is larger) ±1 digit max. | -200 to 850°C input range: (±0.3% of indication value or ±0.8°C, whichever is larger) ±1 digit max. -200 to 200°C input range: (±0.3% of indication value or ±0.5°C, whichever is larger) ±1 digit max. |
| Input type and temperature range | Input accuracy | | | | | | | | | | | | | | | | |
| K, T, and N below -100°C | ±2°C ±1 digit max. | | | | | | | | | | | | | | | | |
| U and L | ±2°C ±1 digit max. | | | | | | | | | | | | | | | | |
| R and S below 200°C | ±3°C ±1 digit max. | | | | | | | | | | | | | | | | |
| B below 400°C | Not specified. | | | | | | | | | | | | | | | | |
| W | ±0.3% of indication value or ±3°C (whichever is larger) ±1 digit max. | | | | | | | | | | | | | | | | |
| PL2 | ±0.3% of indication value or ±2°C (whichever is larger) ±1 digit max. | | | | | | | | | | | | | | | | |
| Conversion cycle | | 250 ms/4 points | | | | | | | | | | | | | | | |
| Temperature conversion data | | Binary data (4-digit hexadecimal when Normal Display Mode is selected or 8-digit hexadecimal when 1/100 Display Mode is selected.) | | | | | | | | | | | | | | | |
| Isolation method | | Between input and communication lines: Photocoupler isolation Between temperature input signals: Photocoupler isolation | | | | | | | | | | | | | | | |
| Mounting method | | 35-mm DIN track mounting | | | | | | | | | | | | | | | |
| Communications power supply current | | 75 mA max. at 24 VDC 110 mA max. at 14 VDC | 75 mA max. at 24 VDC 110 mA max. at 14 VDC | | | | | | | | | | | | | | |
| Weight | | 148 g max. | 147 g max. | | | | | | | | | | | | | | |

Effects of Mounting Direction on Accuracy

A cold junction compensator is included in the Terminal Block of the CRT1-TS04T. The input accuracy depends on the mounting direction if only the Unit is replaced.

| Mounting direction | Input accuracy | | | | | | | | | | | | | | |
|---|--|----------------------------------|----------------|--------------------------|--------------------|---------|--------------------|---------------------|--------------------|---------------|----------------|---|---|-----|---|
| Mounted normally | As specified in the Performance Specifications. | | | | | | | | | | | | | | |
| Mounted in any direction other than the above | ±0.3% of indication value or ±2°C (whichever is larger) ±1 digit max. Indicator Accuracy in Exceptional Cases <table border="1"> <thead> <tr> <th>Input type and temperature range</th> <th>Input accuracy</th> </tr> </thead> <tbody> <tr> <td>K, T, and N below -100°C</td> <td>±3°C ±1 digit max.</td> </tr> <tr> <td>U and L</td> <td>±3°C ±1 digit max.</td> </tr> <tr> <td>R and S below 200°C</td> <td>±4°C ±1 digit max.</td> </tr> <tr> <td>B below 400°C</td> <td>Not specified.</td> </tr> <tr> <td>W</td> <td>±0.3% of indication value or ±4°C (whichever is larger) ±1 digit max.</td> </tr> <tr> <td>PL2</td> <td>±0.3% of indication value or ±3°C (whichever is larger)</td> </tr> </tbody> </table> | Input type and temperature range | Input accuracy | K, T, and N below -100°C | ±3°C ±1 digit max. | U and L | ±3°C ±1 digit max. | R and S below 200°C | ±4°C ±1 digit max. | B below 400°C | Not specified. | W | ±0.3% of indication value or ±4°C (whichever is larger) ±1 digit max. | PL2 | ±0.3% of indication value or ±3°C (whichever is larger) |
| Input type and temperature range | Input accuracy | | | | | | | | | | | | | | |
| K, T, and N below -100°C | ±3°C ±1 digit max. | | | | | | | | | | | | | | |
| U and L | ±3°C ±1 digit max. | | | | | | | | | | | | | | |
| R and S below 200°C | ±4°C ±1 digit max. | | | | | | | | | | | | | | |
| B below 400°C | Not specified. | | | | | | | | | | | | | | |
| W | ±0.3% of indication value or ±4°C (whichever is larger) ±1 digit max. | | | | | | | | | | | | | | |
| PL2 | ±0.3% of indication value or ±3°C (whichever is larger) | | | | | | | | | | | | | | |

Dimensions

CRT1-TS04T
 CRT1-TS04P

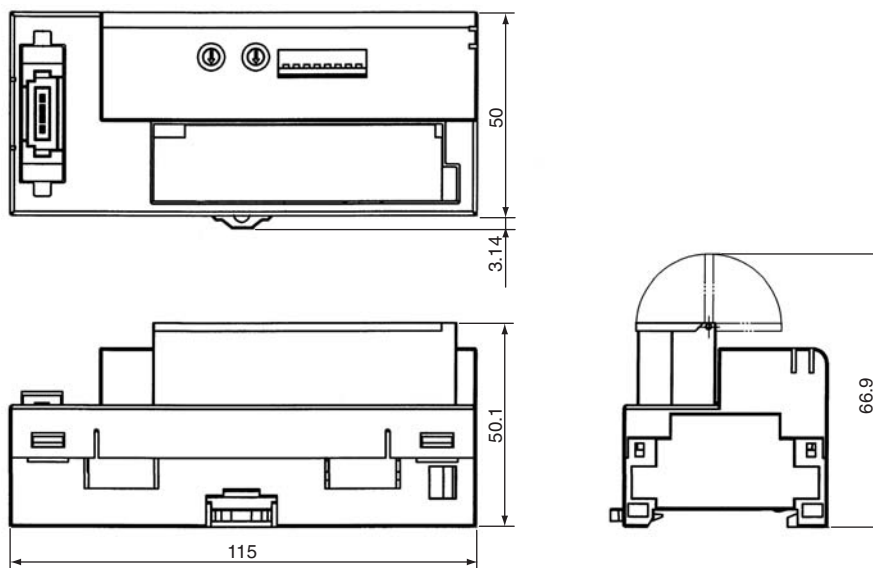

Expansion Units

XWT-ID08(-1)/OD08(-1)/ID16(-1)/OD16(-1)

Expansion I/O Units make expansion easy!

One Expansion Unit can be added to each Digital I/O Slave Unit. This makes a variety of I/O combinations possible, such as 16 inputs + 8 outputs, extending the range of possible system configurations.

- Flexible expansion with many different combinations.
- Removable I/O terminal block enables faster startup time and improved maintainability.
- Collect various preventive maintenance data required to improve productivity, such as information on equipment deterioration due to aging and equipment operating time data.

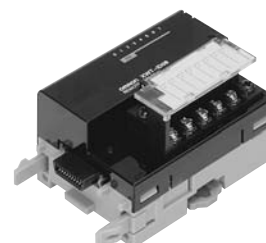

Ordering Information

| Name | Specifications | | | Model |
|-----------------|----------------|------------|-----|------------|
| Expansion Units | Inputs | 8 inputs | NPN | XWT-ID08 |
| | | | PNP | XWT-ID08-1 |
| | Outputs | 8 outputs | NPN | XWT-OD08 |
| | | | PNP | XWT-OD08-1 |
| | Inputs | 16 inputs | NPN | XWT-ID16 |
| | | | PNP | XWT-ID16-1 |
| | Outputs | 16 outputs | NPN | XWT-OD16 |
| | | | PNP | XWT-OD16-1 |

One Expansion Unit can be mounted to one CRT1-ID16(-1), CRT1-OD16(-1), CRT1-ROS16, or CRT1-ROF16 Digital I/O Slave.

Performance Specifications

For Basic Performance Specifications of Slave Units, refer to page 30.

Input Section Specifications

| Item | Specification | | | |
|---|--|--|--|--|
| Model | XWT-ID08 | XWT-ID08-1 | XWT-ID16 | XWT-ID16-1 |
| Internal I/O common | NPN | PNP | NPN | PNP |
| I/O capacity | 8 inputs | | 16 inputs | |
| ON voltage | 15 VDC min. (between each input terminal and the V terminal) | 15 VDC min. (between each input terminal and the G terminal) | 15 VDC min. (between each input terminal and the V terminal) | 15 VDC min. (between each input terminal and the G terminal) |
| OFF voltage | 5 VDC max. (between each input terminal and the V terminal) | 5 VDC max. (between each input terminal and the G terminal) | 5 VDC max. (between each input terminal and the V terminal) | 5 VDC max. (between each input terminal and the G terminal) |
| OFF current | 1.0 mA max. | | | |
| Input current | At 24 VDC: 6.0 mA max./input At 17 VDC: 3.0 mA max./input | | | |
| ON delay | 1.5 ms max. | | | |
| OFF delay | 1.5 ms max. | | | |
| Number of circuits per common | 8 inputs/common | | 16 inputs/common | |
| Communications power supply current consumption | 5 mA max. (24 VDC), 5 mA max. (11 VDC) | | 10 mA max. (24 VDC), 15 mA max. (11 VDC) | |
| Weight | 80 g max. | | 120 g max. | |

Output Section Specifications

| Item | Specification | | | |
|---|--|--|--|--|
| Model | XWT-OD08 | XWT-OD08-1 | XWT-OD16 | XWT-OD16-1 |
| Internal I/O common | NPN | PNP | NPN | PNP |
| I/O capacity | 8 outputs | | 16 outputs | |
| Rated output current | 0.5 A/output, 2.0 A/common | | 0.5 A/output, 4.0 A/common | |
| Residual voltage | 1.2 V max. (0.5 A DC, between each output terminal and the G terminal) | 1.2 V max. (0.5 A DC, between each output terminal and the V terminal) | 1.2 V max. (0.5 A DC, between each output terminal and the G terminal) | 1.2 V max. (0.5 A DC, between each output terminal and the V terminal) |
| Leakage current | 0.1 mA max. | | | |
| ON delay | 0.5 ms max. | | | |
| OFF delay | 1.5 ms max. | | | |
| Number of circuits per common | 8 outputs/common | | 16 outputs/common | |
| Communications power supply current consumption | 5 mA max. (24 VDC), 5 mA max. (11 VDC) | | 10 mA max. (24 VDC), 15 mA max. (11 VDC) | |
| Weight | 80 g max. | | 120 g max. | |

Dimensions

(Unit: mm)

XWT-ID08 (-1)

XWT-OD08 (-1)

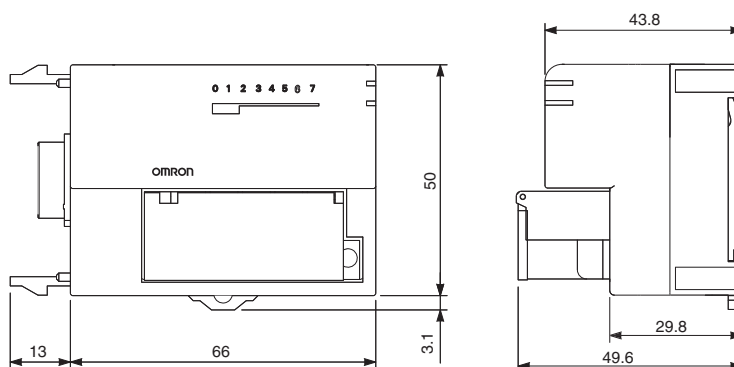

XWT-ID16 (-1)

XWT-OD16 (-1)

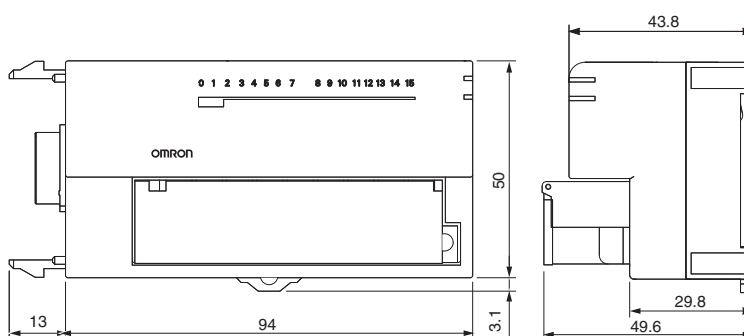

SmartSlice GRT1-series

Flexible I/O Configuration Matched to the Application to Down-size Panels, Lower Costs, and Reduce Wiring Work.

System Configuration

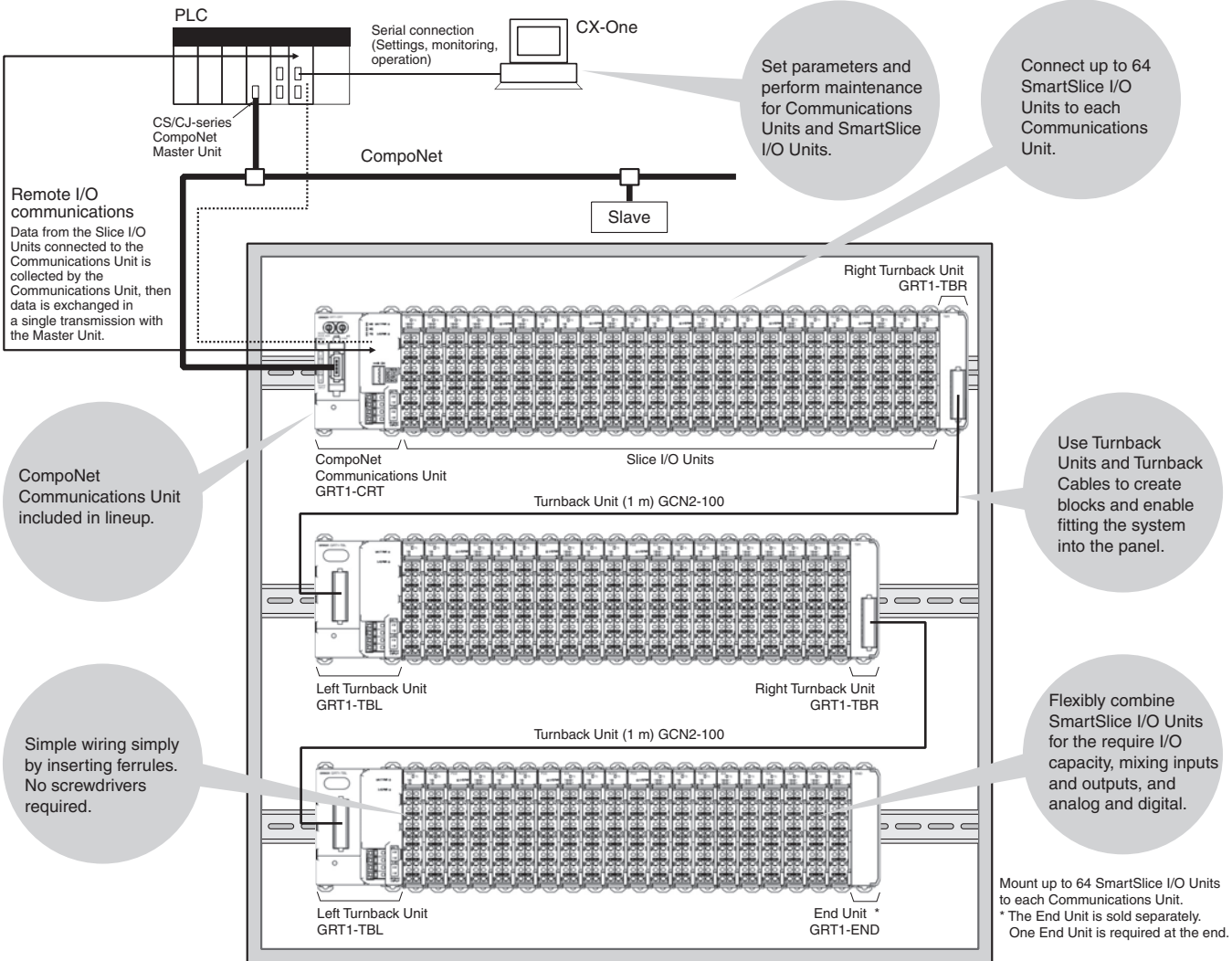

Internal Circuit Configuration

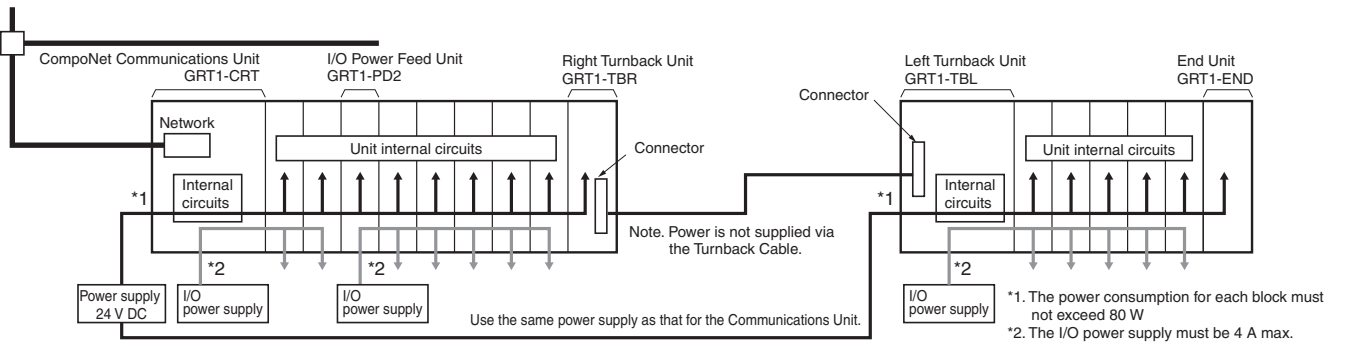

SmartSlice CompoNet Communications Unit

GRT1-CRT

The CompoNet-compliant unit can interface up to 256 inputs and 256 outputs at one node.

- Connects to up to 64 SmartSlice I/O Units.
- Concentrate I/O at one Slave: Up to 256 inputs and 256 outputs.
- Mix different I/O types at one Slave to help save space.
- Just set the node address for easy startup.
- Replace SmartSlice I/O Units online while continuing communications, minimizing system downtime.
- Smart function provided to monitor operating status, facilitating preventive maintenance and increasing operating rates.
- Register dummy SmartSlice I/O to reduce design work for future expansions.



Ordering Information

| Name | Specifications | Model |
|------------------------------|---|----------|
| CompoNet Communications Unit | Connects to up to 64 SmartSlice I/O Units (Inputs: 32 bytes maximum, Outputs: 32 bytes maximum) | GRT1-CRT |

Specifications

| Item | Model | GRT1-DRT |
|-------------------------------|-------|---|
| Network power supply voltage | | 14 to 26.4 V DC |
| Unit power supply voltage | | 20.4 to 26.4 V DC (24 V +10%/–15%) |
| I/O power supply voltage | | 20.4 to 26.4 V DC * (24 V +10%/–15%) |
| Noise immunity | | Conforms to IEC 61000-4-4, 2 kV (power line) |
| Vibration resistance+ | | 10 to 60 Hz, 0.7-mm double amplitude 60 to 150 Hz: 50 m/s ² |
| Shock resistance | | 150 m/s ² |
| Dielectric strength | | 500 V AC between isolated circuits |
| Insulation resistance | | 20 MΩ min. between isolated circuits |
| Ambient operating temperature | | –10 to 55°C (with no icing or condensation) |
| Ambient operating humidity | | 25% to 85% |
| Ambient operating environment | | No corrosive gases |
| Ambient storage temperature | | –25 to 65°C (with no icing or condensation) |
| Mounting method | | 35-mm DIN track mounting |

* For power supply input to the Slice I/O Units.

Specifications of the CompoNet Communications Unit

| Item | Specification |
|--|--|
| I/O points | Inputs: 32 bytes maximum (including status and areas which the Unit does not use) Output: 32 bytes maximum (including areas which the Unit does not use) |
| Maximum number of SmartSlice I/O Units | 64 (Do not count the End Unit.) |
| Status area | 1 word (This word shows the status of the CompoNet Communications Unit.) |
| Parameter backup and restore | You can back up or restore a maximum of 2 KB of data for one CompoNet Communications Unit. |
| Baud rate | The CompoNet Communications Unit uses the baud rate of the CompoNet Master Unit (93.75 kbps, 1.5 Mbps, 3 Mbps, or 4 Mbps). |
| Communications media | You can use these cables: Round Cable I (JIS C 3306, VCTF 2-core 0.75-mm ² twisted-pair cable) Round Cable II (JIS C 3306, VCTF 4-core 0.75-mm ² twisted-pair cable) Flat Cable I (without sheath, DCA4-4F10) Note: The Round Cable I, Round Cable II and Flat Cable I are different types of cable. You must use a Repeater to divide a branch line from the main line to use more than one type of cable. |
| Indicators | MS (green/red): This indicator shows the status of the CompoNet Communications Unit. NS (green/red): This indicator shows the communications status of the CompoNet network. TS (green/red): This indicator shows the status of the SmartSlice I/O Terminal. UNIT PWR (green): This indicator shows the status of the Unit power supply. I/O PWR (green): This indicator shows the status of the I/O power supply. |
| Switches | Rotary switches: There are two rotary switches. You use them to set the node address. DIP switch: There is one DIP switch with four pins. You use them to set the operating mode. |
| Connectors | There is one CompoNet communications connector. |
| Terminals | Clamp terminals for Unit power supply (24 VDC) Clamp terminals for I/O power supply (24 VDC) |
| Power consumption | 2.5 W |
| Power consumption for each SmartSlice I/O Terminal block | 80 W max. (You must divide the I/O Terminal into blocks to use more than 80 W.) |
| SmartSlice I/O Terminal blocks | Main block and a maximum of two expansion blocks |
| Current consumption for I/O power supply | 4 A max. |
| Weight | 137 g |
| Accessories | None |







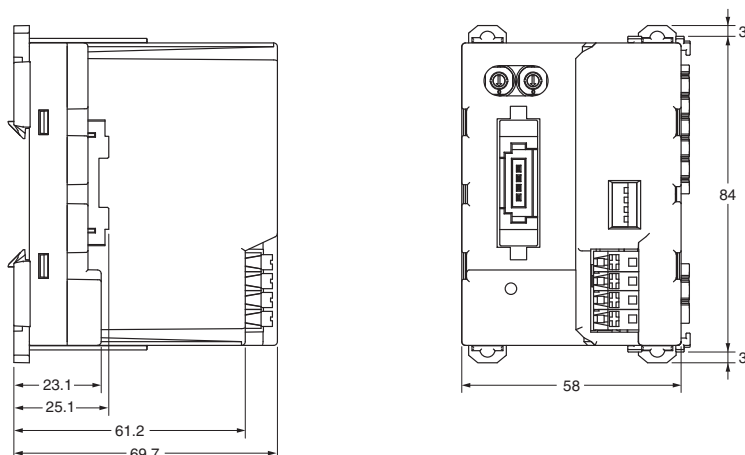

Dimensions

(Unit: mm)

GRT1-CRT



SmartSlice Ordering Information

| Name | | Appearance | Specifications | Model |
|-----------------------------|---|---|--|------------|
| CompoNet Communication Unit | |  | Up to 64 Slice I/O Units can be connected (Inputs: 32 bytes maximum, Output: 32 bytes maximum) | GRT1-CRT |
| Slice I/O Units | Digital I/O Units |  | 4 inputs NPN | GRT1-ID4 |
| | | | 4 inputs PNP | GRT1-ID4-1 |
| | | | 4 outputs NPN | GRT1-OD4 |
| | | | 4 outputs PNP | GRT1-OD4-1 |
| | | | 8 inputs NPN | GRT1-ID8 |
| | | | 8 inputs PNP | GRT1-ID8-1 |
| | | | 8 outputs NPN | GRT1-OD8 |
| | | | 8 outputs PNP | GRT1-OD8-1 |
| | | | Relay Outputs 2 points | GRT1-ROS2 |
| | | | AC Input 4 points | GRT1-IA4-1 |
| | | | | GRT1-IA4-2 |
| | Analog I/O Units |  | Analog inputs (current/voltage) | GRT1-AD2 |
| | | | Analog outputs (current) | GRT1-DA2C |
| | | | Analog output (voltage) | GRT1-DA2V |
| | Temperature Input (Resistance Thermometers) |  | Temperature input (Resistance thermometer:Pt100) 2 points | GRT1-TS2P |
| | | | Temperature input (Resistance thermometer:Pt1000) 2 points | GRT1-TS2PK |
| | | | Thermocouple Input 2 points | GRT1-TS2T |
| | Counter Units |  | Counter inputs: 1, External outputs: 1 NPN | GRT1-CT1 |
| | | | Counter inputs: 1, External outputs: 1 PNP | GRT1-CT1-1 |
| System Units | Turnback Units |  | Right Turnback Unit (Mounts to the right side of Slice I/O Terminal.) | GRT1-TBR |
| | |  | Left Turnback Unit (Mounts to the left side of Slice I/O Terminal. Can supply power to I/O Units.) | GRT1-TBL |
| | Turnback Cable *1 | --- | 1 m | GCN2-100 |
| | I/O Power Feed Unit |  | Use when the total current consumption of the I/O Power Supply exceeds 4 A, or to make the I/O Power Supply a separate system. | GRT1-PD2 |
| | | | | GRT1-PD2G |
| | | | | GRT1-PD8 |
| | | | | GRT1-PD8-1 |
| End Unit *2 |  | Use to add V/G terminals for I/O power supply. | GRT1-PC8 | |
| | | | GRT1-PC8-1 | |
| Option | Terminal Block | --- | Package of 5 Terminal Blocks | GRT1-BT1-5 |

*1 Use the Turnback Cable together with the Turnback Units.

*2 The End Unit is sold separately. It is not provided with the Communications Unit.

Bit Slave Units with Compact Connectors

CRT1B-□D02JS(-1)/□D04JS(-1)

Bit slave of smallest class in industry Innovation in wiring for any type of machinery

- Available in 2 types: 2-point Bit Slave Unit and 4-point Bit Slave Unit.
- Compact size for installation in limited space. Save space and wiring since bit slave can be installed near I/O devices.
- Industry first bit slave connectable with round cables which can be easily purchased at a lower price. Connectable with flat cables, too for easy wiring. Cables are selectable depending on applications.



Ordering Information

| Name | Specifications | | | Model | |
|--------------------|------------------|--------------------|-----|----------------|------------|
| Compact Connectors | Inputs | 2 inputs | NPN | CRT1B-ID02JS | |
| | | 2 outputs | PNP | CRT1B-ID02JS-1 | |
| | Outputs | 2 inputs | NPN | CRT1B-OD02JS | |
| | | 2 outputs | PNP | CRT1B-OD02JS-1 | |
| | Inputs/Outputs | 1 input/1 output | NPN | CRT1B-MD02JS | |
| | | 1 input/1 output | PNP | CRT1B-MD02JS-1 | |
| | Inputs | 4 inputs | NPN | CRT1B-ID04JS | |
| | | 4 outputs | PNP | CRT1B-ID04JS-1 | |
| | Outputs | 4 inputs | NPN | CRT1B-OD04JS | |
| | | 4 outputs | PNP | CRT1B-OD04JS-1 | |
| | Inputs/Outputs | 2 inputs/2 outputs | NPN | CRT1B-MD04JS | |
| | | 2 inputs/2 outputs | PNP | CRT1B-MD04JS-1 | |
| | Mounting Bracket | | | | CRT1-ATT03 |

● Peripheral Devices

For Round Cable I

| Name | Model |
|---|-----------------|
| Open Type Connector (for Unit connection) (Honda Tsushin Kogyo Co.,Ltd.) | HCN-TB4LMZG+ *1 |
| Terminating Resistor | DRS1-T |

For Round Cable II

| Name | Model |
|---|-----------------|
| Open Type Connector (for Unit connection) (Honda Tsushin Kogyo Co.,Ltd.) | HCN-TB4LMZG+ *1 |
| Terminating Resistor | DCN4-TM4 *2 |
| Flat Connector Socket | DCN4-TR4 *2 |

Note: The DCN4-MD4 Multidrop Connector cannot be used with Bit Slaves with Compact Connectors. Use Open Type Connector from Honda Tsushin Kogyo Co., Ltd.

For Flat Cable I

| Name | Model |
|-------------------------------|-------------|
| Flat Connector Socket | DCN4-TR4 *2 |
| Flat Connector Plug | DCN4-BR4 *2 |
| Flat Multidrop Connector Plug | DCN4-MR4 *2 |
| Terminating Resistor | DCN4-TM4 *2 |
| Special Tools | DWT-A01 |

Note: The DCN4-MD4 Multidrop Connector cannot be used with Bit Slaves with Compact Connectors.

*1 For information of HCN-TB4LMZG+, contact to Honda Tsushin Kogyo Co.,Ltd. Tel:+81-52-242-2111

*2 The minimum quantity packaged is 10 Connectors.Oder the Connectors in multiples of 10.

● Compact Connectors

The compact connectors use XA-series Connectors from JST Mfg. Co., Ltd. Special cable connectors must be attached for cables connecting to external devices if a Slave Unit with Compact Connectors is used.

| Name | | Applicable cable range | | | Model | Crimping Tool |
|----------|----------------|------------------------|----------|-------------------------------|---------------|---------------|
| | | mm ² | AWG# | Wire sheath external diameter | | |
| Contacts | Loose terminal | 0.08 to 0.33 | 28 to 22 | 1.2 to 1.9 | BXA-001T-P0.6 | YC-692R |
| | Chain terminal | | | | SXA-001T-P0.6 | YRS-692 |
| | Loose terminal | 0.22 to 0.5 | 24 to 20 | 1.5 to 1.9 | BXA-01T-P0.6 | YC-701R |
| | Chain terminal | | | | SXA-01T-P0.6 | YRS-701 |
| Housing | --- | --- | --- | --- | XAP-03V-1 | --- |

Note 1. Automated Crimp Tools are also available. For details, contact the manufacturer.

2. For information on the processing procedure, refer to the instruction manual included with the tool or contact the manufacturer (JST Mfg. Co., Ltd.).

Performance Specifications

For Basic Performance Specifications of Slave Units, refer to page 30.

Input Section Specifications

| Item | Specification | | | |
|---|---|--|---|--|
| | CRT1B-ID02JS | CRT1B-ID02JS-1 | CRT1B-ID04JS | CRT1B-ID04JS-1 |
| Model | CRT1B-ID02JS | CRT1B-ID02JS-1 | CRT1B-ID04JS | CRT1B-ID04JS-1 |
| I/O capacity | 2 inputs | | 4 inputs | |
| Internal I/O common | NPN | PNP | NPN | PNP |
| ON voltage | 10.5 VDC min. (between each input terminal and the V terminal) | 10.5 VDC min. (between each input terminal and the G terminal) | 10.5 VDC min. (between each input terminal and the V terminal) | 10.5 VDC min. (between each input terminal and the G terminal) |
| OFF voltage | --- | --- | --- | --- |
| OFF current | 1.0 mA max. | | 1.0 mA max. | |
| Input current | 3.0 mA min./input (at 10.5 VDC) | | 3.0 mA min./input (at 10.5 VDC) | |
| Sensor power supply voltage | Communications power supply voltage 0 V (max.) Communications power supply voltage -1 V (min.) | | Communications power supply voltage 0 V (max.) Communications power supply voltage -1 V (min.) | |
| ON delay | 1.5 ms max. | | 1.5 ms max. | |
| OFF delay | 1.5 ms max. | | 1.5 ms max. | |
| Number of circuits per common | 2 inputs/common | | 4 inputs/common | |
| Power short-circuit detection | Not supported. | | Not supported. | |
| Isolation method | No isolation | | No isolation | |
| Input indicators | LEDs (yellow) | | LEDs (yellow) | |
| Degree of protection | IEC standard IP20 | | IEC standard IP20 | |
| Installation | M4 screw mounting using CRT1B-ATT03 Mounting Bracket | | M4 screw mounting using CRT1B-ATT03 Mounting Bracket | |
| Power supply type | Network power supply | | Network power supply | |
| Communications power supply current consumption * | 25 mA max. for 24-VDC power supply voltage 30 mA max. for 14-VDC power supply voltage | | 35 mA max. for 24-VDC power supply voltage 40 mA max. for 14-VDC power supply voltage | |
| Input device supply current | 50 mA/point (G terminal) | 50 mA/point (V terminal) | 50 mA/point (G terminal) | 50 mA/point (V terminal) |
| Weight | 16 g max. | | 21 g max. | |

* The current consumption is for Bit Slave Unit communications current when all inputs are OFF, i.e., it does not include input device current consumption. The communications power supply is also used for the I/O power supply for sensors. Be sure to consider the sensor current consumption and the number of sensors connected in addition to the communications power.

The power supply current consumption is expressed by the following formula.

Communications power supply current consumption = Bit Slave Unit communications current consumption + (Bit Slave Unit input current × number of inputs used) + (sensor current consumption × number of sensors used)

Output Section Specifications

| Item | Specification | | | |
|---|---|--|---|--|
| Model | CRT1B-OD02JS | CRT1B-OD02JS-1 | CRT1B-OD04JS | CRT1B-OD04JS-1 |
| I/O capacity | 2 outputs | | 4 outputs | |
| Internal I/O common | NPN | PNP | NPN | PNP |
| Rated output current | 0.1 A/output | | 0.1 A/output | |
| Load power supply voltage | Communications power supply voltage 0 V (max.) Communications power supply voltage -1.2 V (min.) | | Communications power supply voltage 0 V (max.) Communications power supply voltage -1.2 V (min.) | |
| Residual voltage | 1.2 V max. (0.1 A DC, between each output terminal and G terminal) | 1.2 V max. (0.1 A DC, between each output terminal and V terminal) | 1.2 V max. (0.1 A DC, between each output terminal and G terminal) | 1.2 V max. (0.1 A DC, between each output terminal and V terminal) |
| Leakage current | 0.1 mA max. | | 0.1 mA max. | |
| ON delay | 0.5 ms max. | | 0.5 ms max. | |
| OFF delay | 1.5 ms max. | | 1.5 ms max. | |
| Number of circuits per common | 2 outputs/common | | 4 outputs/common | |
| Load short-circuit detection | Not supported. | | Not supported. | |
| Isolation method | No isolation | | No isolation | |
| Output indicators | LEDs (yellow) | | LEDs (yellow) | |
| Degree of protection | IEC standard IP20 | | IEC standard IP20 | |
| Installation | M4 screw mounting using CRT1B-ATT03 Mounting Bracket | | M4 screw mounting using CRT1B-ATT03 Mounting Bracket | |
| Power supply type | Network power supply | | Network power supply | |
| Communications power supply current consumption (See note.) | 25 mA max. for 24-VDC power supply voltage 30 mA max. for 14-VDC power supply voltage | | 30 mA max. for 24-VDC power supply voltage 35 mA max. for 14-VDC power supply voltage | |
| Output device supply current | 30 mA/point (G terminal) | 30 mA/point (V terminal) | 30 mA/point (G terminal) | 30 mA/point (V terminal) |
| Weight | 16 g max. | | 21 g max. | |

* The current consumption is for Bit Slave Unit communications current when all outputs are OFF, i.e., it does not include the output device load current consumption. The communications power supply is also used for the I/O power supply for actuators. Be sure to consider the actuator load current consumption and the number of sensors connected in addition to the communications power. The power supply current consumption is expressed by the following formula.

Communications power supply current consumption = Bit Slave Unit communications current consumption + (actual load current × number of actuators used)

Input and Output Section Specifications

● 1-point Input and 1-point Output units

Input Section Specification

| Item | Specification | |
|---|---|---|
| | CRT1B-MD02JS | CRT1B-MD02JS-1 |
| Model | CRT1B-MD02JS | CRT1B-MD02JS-1 |
| I/O capacity | 1 input | |
| Internal I/O common | NPN | PNP |
| ON voltage | 10.5 VDC min. (between each input terminal and the V terminal) | 10.5 VDC min. (between each input terminal and the G terminal) |
| OFF voltage | --- | --- |
| OFF current | 1.0 mA max. | |
| Input current | 3.0 mA min./input (at 10.5 VDC) | |
| Sensor power supply voltage | Communications power supply voltage 0 V (max.) Communications power supply voltage -1 V (min.) | |
| ON delay | 1.5 ms max. | |
| OFF delay | 1.5 ms max. | |
| Number of circuits per common | 1 input/common | |
| Power short-circuit detection | Not supported. | |
| Isolation method | No isolation | |
| Input indicators | LEDs (yellow) | |
| Degree of protection | IEC standard IP20 | |
| Installation | M4 screw mounting using CRT1B-ATT03 Mounting Bracket | |
| Power supply type | Network power supply | |
| Communications power supply current consumption * | 25 mA max. for 24-VDC power supply voltage 30 mA max. for 14-VDC power supply voltage | |
| Input device supply current | 50 mA/point (G terminal) | 50 mA/point (V terminal) |
| Weight | 16 g max. | |

Output Section Specification

| Item | Specification | |
|-------------------------------|---|---|
| | CRT1B-MD02JS | CRT1B-MD02JS-1 |
| Model | CRT1B-MD02JS | CRT1B-MD02JS-1 |
| I/O capacity | 1 output | |
| Internal I/O common | NPN | PNP |
| Rated output current | 0.1 A/output | |
| Load power supply voltage | Communications power supply voltage 0 V (max.) Communications power supply voltage -1.2 V (min.) | |
| Residual voltage | 1.2 V max. (DC, 0.1 A, between each output terminal and G terminal) | 1.2 V max. (DC, 0.1 A, between each output terminal and V terminal) |
| Leakage current | 0.1 mA max. | |
| ON delay | 0.5 ms max. | |
| OFF delay | 1.5 ms max. | |
| Number of circuits per common | 1 output/common | |
| Load short-circuit detection | Not supported. | |
| Isolation method | No isolation | |
| Output indicators | LEDs (yellow) | |
| Degree of protection | IEC standard IP20 | |
| Installation | M4 screw mounting using CRT1B-ATT03 Mounting Bracket | |
| Power supply type | Network power supply | |
| Output device supply current | 30 mA/point (G terminal) | 30 mA/point (V terminal) |

* The current consumption is for Bit Slave Unit communications current when all inputs are OFF, i.e., it does not include input device current consumption. The communications power supply is also used for the I/O power supply for sensors. Be sure to consider the sensor current consumption and the number of sensors connected in addition to the communications power. The power supply current consumption is expressed by the following formula.

Communications power supply current consumption = Bit Slave Unit communications current consumption + (Bit Slave Unit input current × number of inputs used) + (sensor current consumption × number of sensors used)

● 2-points Inputs and 2-points Outputs units

Input Section Specification

| Item | Specification | |
|---|---|---|
| Model | CRT1B-MD04JS | CRT1B-MD04JS-1 |
| I/O capacity | 2 inputs | |
| Internal I/O common | NPN | PNP |
| ON voltage | 10.5 VDC min. (between each input terminal and the V terminal) | 10.5 VDC min. (between each input terminal and the G terminal) |
| OFF voltage | --- | --- |
| OFF current | 1.0 mA max. | |
| Input current | 3.0 mA min./input (at 10.5 VDC) | |
| Sensor power supply voltage | Communications power supply voltage 0 V (max.) Communications power supply voltage -1 V (min.) | |
| ON delay | 1.5 ms max. | |
| OFF delay | 1.5 ms max. | |
| Number of circuits per common | 2 inputs/common | |
| Power short-circuit detection | Not supported. | |
| Isolation method | No isolation | |
| Input indicators | LEDs (yellow) | |
| Degree of protection | IEC standard IP20 | |
| Installation | M4 screw mounting using CRT1B-ATT03 Mounting Bracket | |
| Power supply type | Network power supply | |
| Communications power supply current consumption * | 35 mA max. for 24-VDC power supply voltage 40 mA max. for 14-VDC power supply voltage | |
| Input device supply current | 50 mA/point (G terminal) | 50 mA/point (V terminal) |
| Weight | 21 g max. | |

Output Section Specification

| Item | Specification | |
|-------------------------------|---|---|
| Model | CRT1B-MD04JS | CRT1B-MD04JS-1 |
| I/O capacity | 2 outputs | |
| Internal I/O common | NPN | PNP |
| Rated output current | 0.1 A/output | |
| Load power supply voltage | Communications power supply voltage 0 V (max.) Communications power supply voltage -1.2 V (min.) | |
| Residual voltage | 1.2 V max. (DC, 0.1 A, between each output terminal and G terminal) | 1.2 V max. (DC, 0.1 A, between each output terminal and V terminal) |
| Leakage current | 0.1 mA max. | |
| ON delay | 0.5 ms max. | |
| OFF delay | 1.5 ms max. | |
| Number of circuits per common | 2 outputs/common | |
| Load short-circuit detection | Not supported. | |
| Isolation method | No isolation | |
| Output indicators | LEDs (yellow) | |
| Degree of protection | IEC standard IP20 | |
| Installation | M4 screw mounting using CRT1B-ATT03 Mounting Bracket | |
| Power supply type | Network power supply | |
| Output device supply current | 30 mA/point (G terminal) | 30 mA/point (V terminal) |

* The current consumption is for Bit Slave Unit communications current when all inputs are OFF, i.e., it does not include input device current consumption. The communications power supply is also used for the I/O power supply for sensors. Be sure to consider the sensor current consumption and the number of sensors connected in addition to the communications power. The power supply current consumption is expressed by the following formula.

Communications power supply current consumption = Bit Slave Unit communications current consumption + (Bit Slave Unit input current × number of inputs used) + (sensor current consumption × number of sensors used)

Wiring Wire colors have been changed according to revisions in the JIS standards for photoelectric and proximity sensors. The colors in parentheses are the wire colors prior to the revisions.

The I/O connector section uses compact connectors. Pin arrangements and signals are shown below. The figure of connector shows the side to insert cables.

●2-points Inputs/4-points Inputs type

CRT1B-ID02JS (NPN)
CRT1B-ID04JS (NPN)

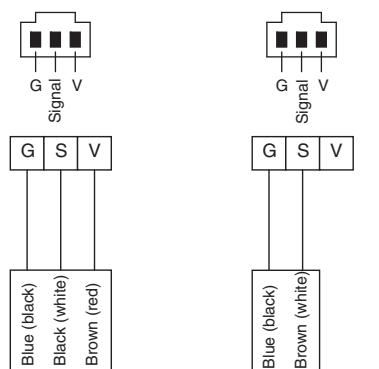

3-wire sensor with NPN output (photoelectric sensor or proximity sensor)

2-wire sensor (e.g., limit switch)

CRT1B-ID02JS-1 (PNP)
CRT1B-ID04JS-1 (PNP)

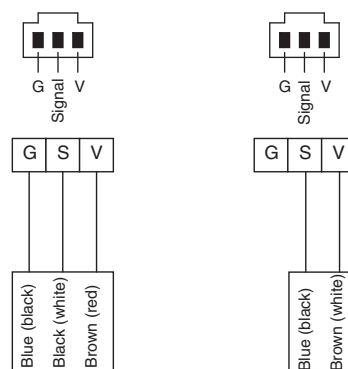

3-wire sensor with PNP output (photoelectric sensor or proximity sensor)

2-wire sensor (e.g., limit switch)

●2-points Outputs/4-points Outputs type

CRT1B-OD02JS (NPN)
CRT1B-OD04JS (NPN)

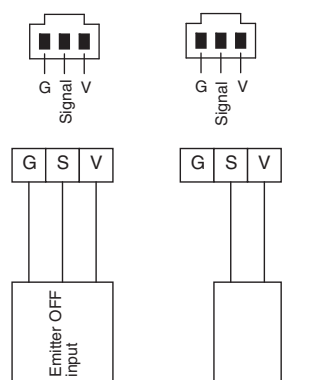

Photoelectric sensor, emitter, etc.

Solenoid, valve, etc.

CRT1B-OD02JS-1 (PNP)
CRT1B-OD04JS-1 (PNP)

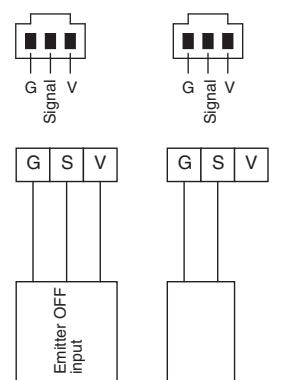

Photoelectric sensor, emitter, etc.

Solenoid, valve, etc.

● 1-point Input/1-point Output type, 2-points Inputs/2-points Outputs type

CRT1B-MD02JS (NPN)

CRT1B-MD04JS (NPN)

Input Connectors

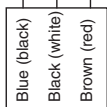
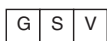
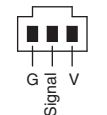

3-wire sensor with NPN output (photoelectric sensor or proximity sensor)

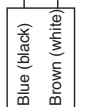
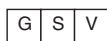
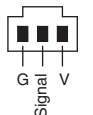

2-wire sensor (e.g., limit switch)

Output Connectors

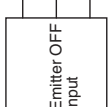
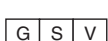
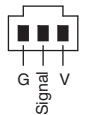

Photoelectric sensor, emitter, etc.

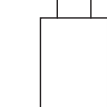
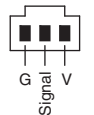

Solenoid, valve, etc.

CRT1B-MD02JS-1 (PNP)

CRT1B-MD04JS-1 (PNP)

Input Connectors

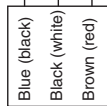
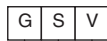
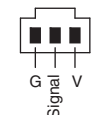

3-wire sensor with PNP output (photoelectric sensor or proximity sensor)

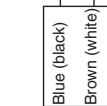
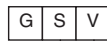
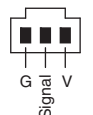

2-wire sensor (e.g., limit switch)

Output Connectors

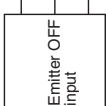
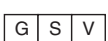
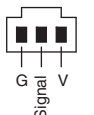

Photoelectric sensor, emitter, etc.

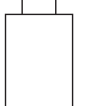
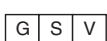
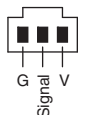

Solenoid, valve, etc.

Dimensions

(Unit: mm)

●2-points Inputs, 2-points Outputs, 1-point Input/1-point Output type

- CRT1B-ID02JS
- CRT1B-ID02JS-1
- CRT1B-OD02JS
- CRT1B-OD02JS-1
- CRT1B-MD02JS
- CRT1B-MD02JS-1

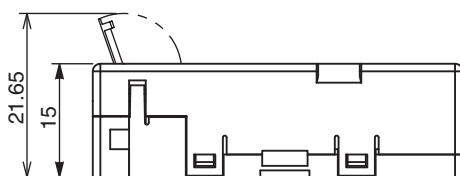
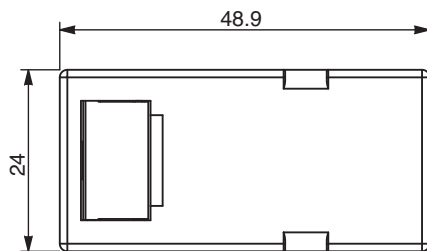

●4-points Inputs, 4-points Outputs, 2-points Inputs/2-points Outputs type

- CRT1B-ID04JS
- CRT1B-ID04JS-1
- CRT1B-OD04JS
- CRT1B-OD04JS-1
- CRT1B-MD04JS
- CRT1B-MD04JS-1

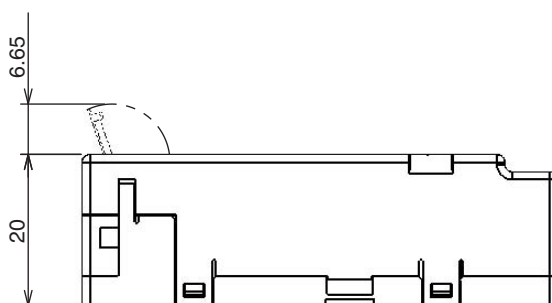
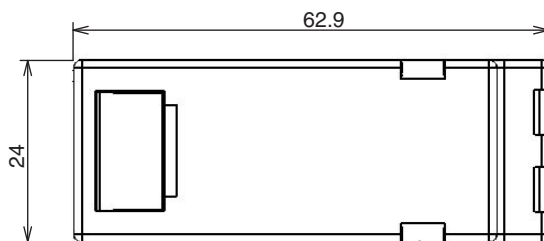

Bit Slave Units with e-CON Connectors

CRT1B-□D02S(-1)**Simple and Intelligent Bit Slaves with Industry-standard e-CON connectors.**

Slave Units capable of 2-point bit-level distribution. The I/O power supply is supplied from the communications power in the previously connected flat cable, and has a short-circuit detection function for protection.

- Industry-standard e-CON connectors
- Short-circuit protection safeguards the network from I/O short circuits.
- Simple communications connections with flat cable and connectors.
- Bit-level distribution to support essentially any application.

**Ordering Information**

| Name | Specifications | | | Model |
|---------------------------------------|----------------|-----------|-----|---------------|
| Bit Slave Units with e-CON Connectors | Inputs | 2 inputs | NPN | CRT1B-ID02S |
| | | | PNP | CRT1B-ID02S-1 |
| | Outputs | 2 outputs | NPN | CRT1B-OD02S |
| | | | PNP | CRT1B-OD02S-1 |

Performance Specifications

For Basic Performance Specifications of Slave Units, refer to page 30.

Input Section Specifications

| Item | Specification | |
|---|--|--|
| Model | CRT1B-ID02S | CRT1B-ID02S-1 |
| I/O capacity | 2 inputs | |
| Internal I/O common | NPN | PNP |
| ON voltage | 10.5 VDC min. (between each input terminal and the V terminal) | 10.5 VDC min. (between each input terminal and the G terminal) |
| OFF voltage | 5 VDC max. (between each input terminal and the V terminal) | 5 VDC max. (between each input terminal and the G terminal) |
| OFF current | 1.0 mA max. | |
| Input current | 3.0 mA max./input (at 10.5 VDC) | |
| Sensor power supply voltage | Communications power supply voltage + 0 V (max.) Communications power supply voltage - 1 V (min.) | |
| ON delay | 1.5 ms max. | |
| OFF delay | 1.5 ms max. | |
| Number of circuits per common | 2 inputs/common | |
| Power short-circuit detection | Supported | |
| Isolation method | No isolation | |
| Input indicators | LEDs (yellow) | |
| Degree of protection | IEC standard IP20 | |
| Installation | Screw installation (M4) | |
| Power supply type | Network power supply | |
| Communications power supply current consumption * | 65 mA max. for 24-VDC power supply voltage 80 mA max. for 14-VDC power supply voltage | 45 mA max. for 24-VDC power supply voltage 65 mA max. for 14-VDC power supply voltage |
| Weight | 70 g max. | |

* The current consumption is for Bit Slave Unit communications current when all inputs are OFF, i.e., it does not include input device current consumption. The communications power supply is also used for the I/O power supply for sensors. Be sure to consider the sensor current consumption and the number of sensors connected in addition to the communications power.

The power supply current consumption is expressed by the following formula.

Communications power supply current consumption = Bit Slave Unit communications current consumption + (Bit Slave Unit input current x number of inputs used) + (sensor current consumption x number of sensors used)

Output Section Specifications

| Item | Specification | |
|---|--|--|
| Model | CRT1B-OD02S | CRT1B-OD02S-1 |
| I/O capacity | 2 outputs | |
| Internal I/O common | NPN | PNP |
| Rated output current | 0.2 A/output | |
| Load power supply voltage | Communications power supply voltage + 0 V (max.) Communications power supply voltage – 1.2 V (min.) | |
| Residual voltage | 1.2 V max. (0.2 A DC, between each output terminal and the BS- | 1.2 V max. (0.2 A DC, between each output terminal and the BS+ |
| Leakage current | 0.1 mA max. | |
| ON delay | 0.5 ms max. | |
| OFF delay | 1.5 ms max. | |
| Number of circuits per common | 2 outputs/common | |
| Load power short-circuit detection | Supported | |
| Isolation method | No isolation | |
| Output indicators | LEDs (yellow) | |
| Degree of protection | IEC standard IP20 | |
| Installation | Screw installation (M4) | |
| Power supply type | Network power supply | |
| Communications power supply current consumption * | 55 mA max. for 24-VDC power supply voltage 75 mA max. for 14-VDC power supply voltage | 55 mA max. for 24-VDC power supply voltage 70 mA max. for 14-VDC power supply voltage |
| Weight | 59 g max. | |

* The current consumption is for Bit Slave Unit communications current when all outputs are OFF, i.e., it does not include output device load current consumption. The communications power supply is also used for the I/O power supply for actuators. Be sure to consider the actuator load current consumption and the number of actuators connected in addition to the communications power.

The power supply current consumption is expressed by the following formula.

Communications power supply current consumption = Bit Slave Unit communications current consumption + (Bit Slave Unit input current x number of inputs used) + (actuator load current x number of actuators used)

Dimensions

(Unit: mm)

CRT1B-ID02S(-1)
 CRT1B-OD02S(-1)

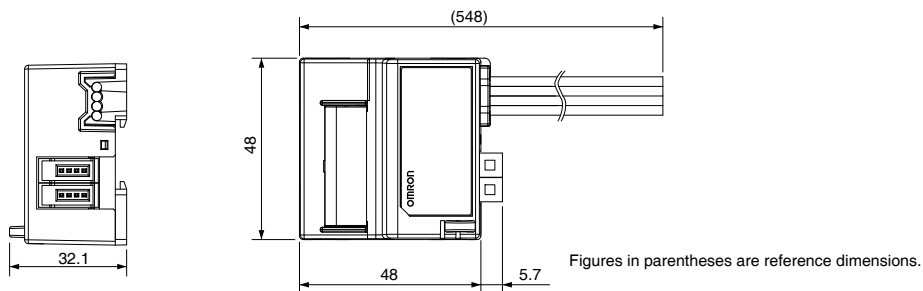

Repeater Unit

CRS1-RPT01

Simple and Intelligent Repeater Units Extend the Network

Repeater Units can make CompoNet Networks easier to wire, and extend cable length.

When Repeater Units are connected in series from the Master Unit, up to two extra segment layers can be created (i.e., up to 2 Repeater Units are allowed between a Slave Unit and the Master Unit).

- Expand the network to up to 1,500 m using two segment layers of Repeater Units (baud rate: 93.75 kbps).
- Avoid total system breakdown caused by errors in lower-level Units.
- Repeater Units allow a different cable types to be used in the same network.
- Implement various network layouts by branching lines or extending the trunk line.
- Display a network configuration list or identify error locations by using the setting and monitoring software for CompoNet.
- Monitor the power supply for the entire network with communications power supply monitoring function.



Ordering Information

| Name | Specifications | Model |
|---------------|--|--------------|
| Repeater Unit | A sub-trunk line can be connected downstream (for trunk-branch line configuration) or further branching is enabled downstream (for configurations with no wiring restrictions) in the same way as for a Master Unit. A Repeater Unit can be used to branch the trunk line and increase the number of connected Units, as well as to extend the length of the communications line. | CRS1-RPT01 * |

* These Units are also available with a DCN-TB4 Terminal Conversion Adapter included in the package. Add "(-B)" to the end of the model number to receive the Adapter as well.

Specifications

| Item | Specification |
|--|---|
| Model | CRS1-RPT01 |
| Communications ports | Upstream port (port 1): Trunk line or sub-trunk line Downstream port (port 2): Sub-trunk line (Can be wired with the same communications specifications as the Master Unit.) Different types of communications cable can be connected to the upstream and downstream ports. |
| Maximum number of layers | Up to two extra segment layers can be created from the Master Unit. |
| Number of nodes per network (per Master Unit) | 64 nodes |
| Number of nodes per trunk line or sub-trunk line | 32 nodes (Including Slave Units) |
| Communications power supply connector | One downstream communications port power supply connector Note: Communications power for the Repeater Unit is supplied from the BS+ and BS- terminals on the upstream port communications connector (PORT1). |
| Communications power supply connector allowable current capacity | 5 A max. |
| Noise immunity | Conforms to IEC 61000-4-4 2 kV (power line). |
| Vibration resistance | 10 to 150 Hz with double-amplitude of 0.7 mm or 50 m/s ² |
| Shock resistance | 150 m/s ² |
| Dielectric strength | 500 VAC (between isolated circuits) |
| Insulation resistance | 20 MΩ min. (between isolated circuits) |
| Ambient operating temperature | -10 to 55°C |
| Ambient operating humidity | 25% to 85% (with no condensation) |
| Ambient operating atmosphere | No corrosive gases |
| Storage temperature | -25 to 65°C |
| Storage humidity | 25% to 85% (with no condensation) |
| Installation | DIN Track or M4 screws |
| Weight | 73 g |
| Communications power supply voltage | 14 to 26.4 VDC |
| Communications power supply current consumption | 95 mA max. |

● Slave Port Communications Power Supply Connector

This connector supplies communications power to Slave Units and Repeater Units connected to the Slave port communications connector (port 2).

| | |
|-----|-------------------------------|
| BS+ | Communications power supply + |
| BS- | Communications power supply - |

Note: Communications power for the Repeater Unit is supplied from the BS+ and BS- terminals on the upstream port communications connector (port 1).

Recommended Ferrules

The following ferrules are recommended for the communications power supply cable.

| Product number | Applicable power cable size | Crimping tool | Manufacturer |
|----------------|-----------------------------|--|----------------------------|
| AI0,5-10 WH | 0.5 mm (AWG20) | CRIMPFOX UD6 (Product No. 1204436) or CRIMPTFOX ZA3 series | Phoenix Contact K.K. |
| H0.5/16 orange | 0.5 mm (AWG20) | Crimper PZ1.5 (Product No. 900599) | Weidmueller Japan Co.,Ltd. |

The following screwdriver is recommended for use when removing ferrules.

| Product number | Manufacturer |
|----------------|-------------------|
| XW4Z-00C | OMRON Corporation |

Dimensions

(Unit: mm)

CRS1-RPT01

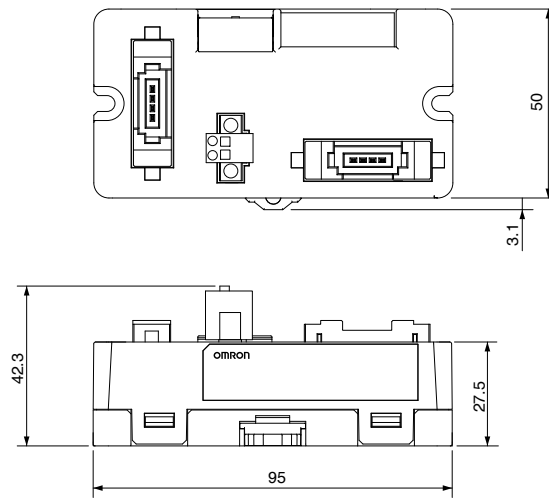

Sensor Communication Unit (CompoNet)

E3X-CRT

CompoNet Sensor Communications Unit that Simplifies Sensor Setting Management

- Transmit ON/OFF signals to a PLC without a program (CompoNet communication slave function).
- Supports operations such as reading, writing, and teaching detection amounts, threshold values, and function settings (by way of the explicit message function).
- Supports wire saving by requiring only the wiring necessary to connect the communication cable to the amplifier placed next to the E3X-CRT.
- Supports connection 16 pcs amplifier (max).*

* Change by operation mode



Ordering Information

● CompoNet Slave Sensor Communication Unit

| I/O Classification | Allocated bits | Internal circuit power supply | Power Supply Voltage | Model |
|-----------------------------|----------------|--|----------------------|---------|
| Change by operation model * | | Supplied along with communications power | 24VDC | E3X-CRT |

* The E3X-CRT has two operating modes; I/O mode 1 and I/O mode 2. The following table gives the differences between these modes.

| Mode | I/O Classification | Allocated bits | Connection amplifier number (max) |
|-----------|-----------------------|-------------------------------|-----------------------------------|
| I/O mode1 | Input Unit | Input: 32bit | 15 |
| I/O mode2 | Input and Output Unit | Input: 64bit Output: 64bit | 16 |

● Supports Sensor Amplifier

| Unit | Characteristic | Connection Method | Power Supply | Model |
|-------------------------------|---|---|---|-------------|
| Standard fiber amplifier | Simple setting and operation Fiber Amplifier | Connect to a communication unit Only by connector | Supplied along with a power supply connector. | E3X-HD0 |
| 2CH Fiber amplifier | Supports connection 2CH fiber Amplifier | | | E3X-MDA0 * |
| High-function fiber amplifier | Supports setting 2 thresholds fiber Amplifier | | | E3X-DA0-S * |
| Laser sensor amplifier | Laser type digital Sensor Amplifier | | | E3C-LDA0 * |
| Proximity sensor amplifier | High Precision Proximity Sensor Amplifier | | | E2C-EDA0 |

Note. Limitation about amplifier setting: See the E3X-ECT User's manual (Man No.E413).

* Product no longer available to order.

Ratings and Specifications

| | |
|---|---|
| Communications power | DC14-26.4V(supply from communication connector) |
| Power supply wattage and current | 2.4 W (max) (Not include sensors current) 100 mA (max) DC24V (Not include sensors current) |
| Communication method | CompoNet |
| Function | I/O communication, explicit message, Sensor Error Output |
| Indicators | MS (green/red), NS (green/red), SS (Sensor Status) (green/red) |
| Vibration resistance | 10 to 150 Hz with double-amplitude of 0.7 mm or 50 m/s ² 80 minutes |
| Shock resistance | 150 m/s ² 3 directions each 3 times |
| Dielectric strength | AC 500V 50/60Hz 1min |
| Insulation resistance | 20 MΩ min. |

| | |
|--|---|
| Ambient operating temperature | 0 to 55°C * |
| Ambient operating humidity | 25-85% (with no condensation) |
| Storage temperature | -30 to +70°C (No icing or condensation) |
| Storage humidity | 25 to 85% (No icing or condensation) |
| Installation | Mounted on 35-mm DIN Track |
| Accessories | Connector Cover, Brackets for DIN |
| Weight (packed state/unit only) | 220/95 g (max) |

* Limitation of the temperature by connection amplifiers number below.

- 1 to 2 : 0 to 55 °C,
- 3 to 10: 0 to 50 °C,
- 11 to 16: 0 to 45 °C

Dimensions

(Unit: mm)

E3X-CRT

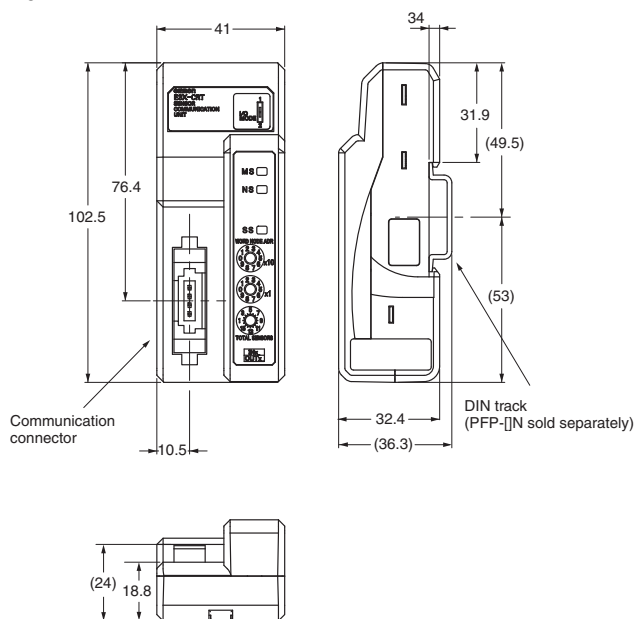

E3X-HD0

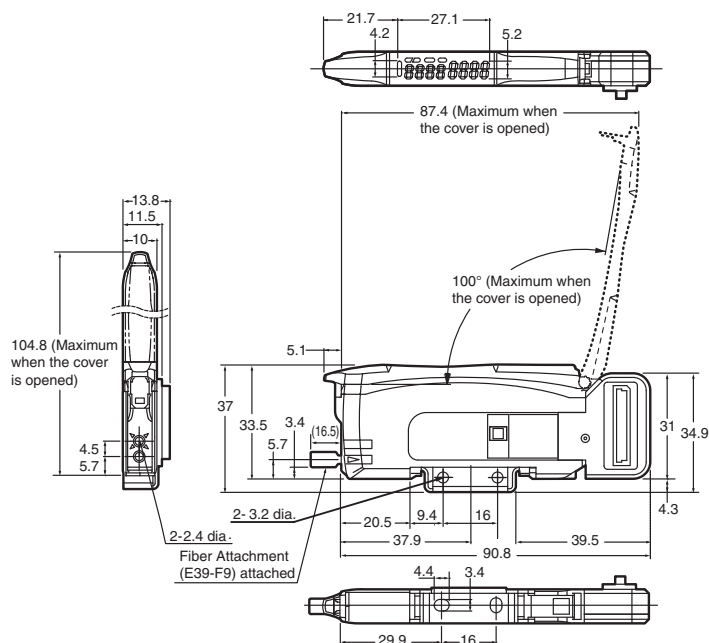

E3C-LDA0 *

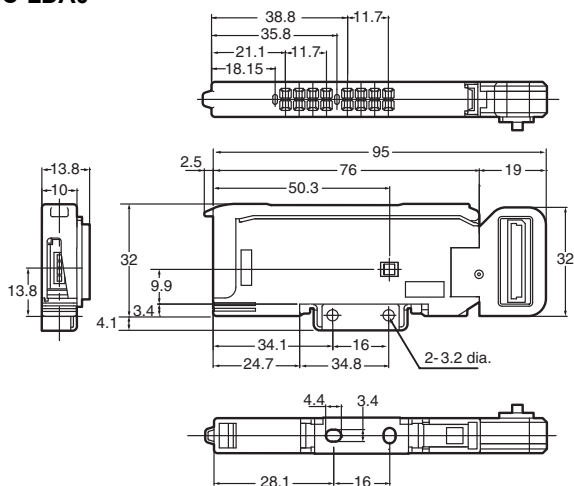

E3X-MDA0 *

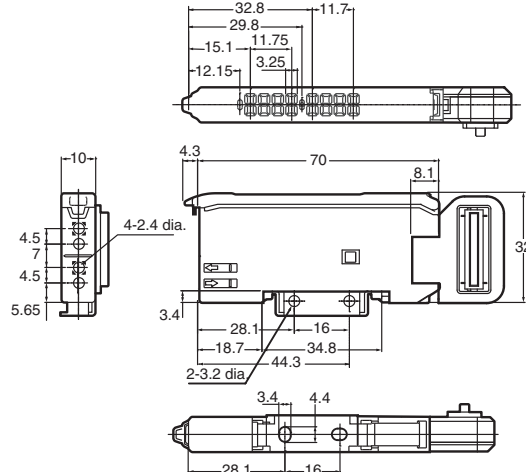

E2C-EDA0

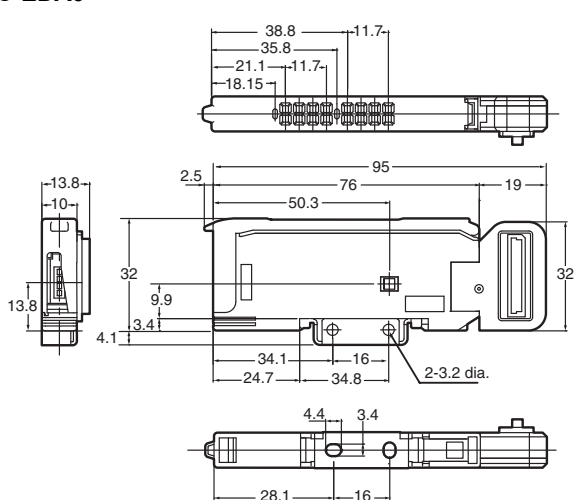

E3X-DA0-S *

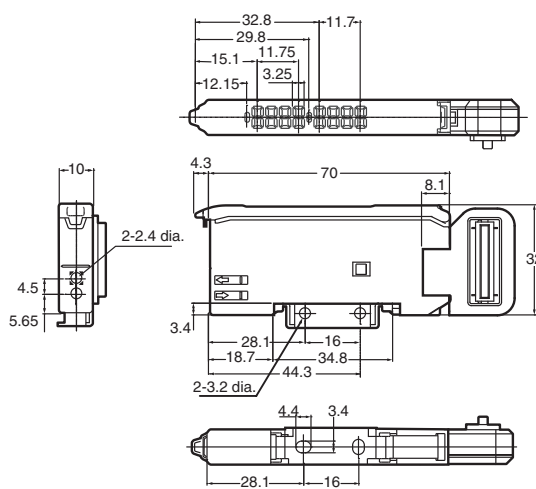

* Product no longer available to order.

Multi-function Compact Inverter MX2-Series V1 type CompoNet Communication Unit 3G3AX-MX2-CRT-E

Support for open network with CompoNet Communications Unit

- Reduced wiring of Multi-function compact inverter MX2 series *1
- 8 types of remote I/O functions
The unique remote I/O functions in addition to remote I/O functions of CompoNet communications standard
- Parameter edit via CompoNet by using support tool CX-Drive *2

*1 CompoNet communication unit can be used with the inverter 3G3MX2 of unit version 1.1 or higher.
*2 CX-Drive can be used with version 2.6 or higher.



Ordering Information

| Name | Mountable Inverter | Model |
|-----------------------------|--------------------|-----------------|
| CompoNet communication unit | MX2-series | 3G3AX-MX2-CRT-E |

Performance Specifications

| | |
|-------------------------------|---|
| Power supply | Supplied from the inverter |
| Protective structure | IP20 |
| Ambient Operating Temperature | -10 to 50°C |
| Ambient Storage Temperature | -20 to 65°C |
| Ambient Operating Humidity | 20 to 90%RH (with no condensation) |
| Vibration Resistance | 5.9m/s ² (0.6G) , 10 to 55Hz |
| Application Environment | At a maximum altitude of 1,000 m; indoors (without corrosive gases or dust) |
| Insulation Resistance | 500VAC (between isolated circuits) |
| Weight | 100 g max. (Shipping weight: approx. 170 g) |
| Number of Words allocated | Initial setting IN:2CH/OUT:2CH (At maximum setting IN:8CH/OUT:8CH) |

Note. For detail, refer to the MX2-series Catalog (Cat. No.I916).

Dimensions

(Unit: mm)

3G3AX-MX2-CRT-E

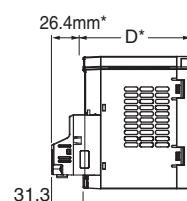
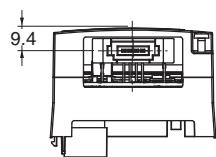
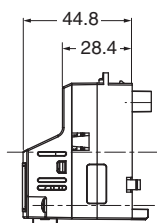
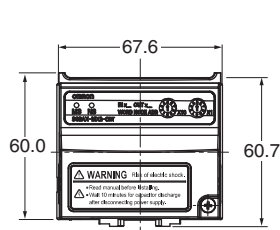

Note. After the CompoNet Communication Unit is installed, dimension D of the inverter increases by 26.4 mm. (Dimension D of the inverter varies depending on the capacity. Refer to the MX2-series USER'S MANUAL(Cat.No.I570))

High-function General-purpose Inverter RX-Series V1 type CompoNet Communication Unit 3G3AX-RX-CRT-E

Support for open network with CompoNet Communications Unit

- Reduced wiring of High-function General-purpose Inverter RX-Series V1 type *1
- 8 types of remote I/O functions

The unique remote I/O functions in addition to remote I/O functions of CompoNet communications standard

- Parameter edit via CompoNet by using support tool CX-Drive *2

*1 It is not possible to use a CompoNet Communication Unit with a RX-series (Model without "-V1").

*2 CX-Drive can be used with version 2.6 or higher.

Note. Inverters RX-Series V1 type in this catalog have been discontinued.



Ordering Information

| Name | Mountable Inverter | Model |
|-----------------------------|--------------------|----------------|
| CompoNet communication unit | RX-Series V1 type | 3G3AX-RX-CRT-E |

Performance Specifications

| | |
|-------------------------------|---|
| Power supply | Supplied from the inverter |
| Protective structure | IP20 |
| Ambient Operating Temperature | -10 to 50°C |
| Ambient Storage Temperature | -20 to 65°C |
| Ambient Operating Humidity | 20 to 90%RH (with no condensation) |
| Vibration Resistance | 5.9m/s ² (0.6G) , 10 to 55Hz |
| Application Environment | At a maximum altitude of 1,000 m; indoors (without corrosive gases or dust) |
| Insulation Resistance | 500VAC (between isolated circuits) |
| Weight | 100 g max. (Shipping weight: approx. 170 g) |
| Number of Words allocated | Initial setting IN:2CH/OUT:2CH (At maximum setting IN:8CH/OUT:8CH) |

Note. For detail, refer to the RX-Series V1 type Catalog (Cat. No.I919).

Dimensions

(Unit: mm)

3G3AX-RX-CRT-E

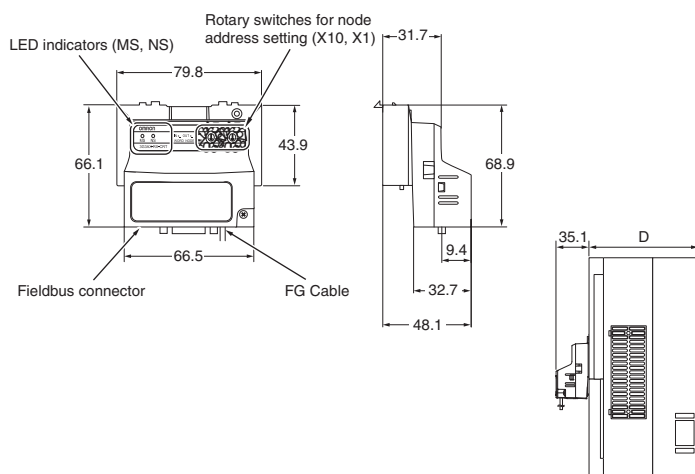

Note. After the CompoNet Communication Unit is installed, dimension D of the inverter increases by 35.1 mm. (Dimension D of the inverter varies depending on the capacity. Refer to the RX-Series V1 type USER'S MANUAL(Cat.No.I578))

Appendix

| | |
|--|-----|
| CompoNet Network Configuration Elements | 96 |
| Types of Node Addresses for CompoNet Networks..... | 97 |
| CompoNet Network Specification | 98 |
| Communications and I/O Power Supply Wiring | 99 |
| Connecting External I/O for Slave Units..... | 101 |
| ■ Connecting to e-CON Connector Terminals | |
| ■ Connecting to MIL Connector Terminals | |
| ■ Connecting to Screw-less Clamp Terminal Blocks | |

CompoNet Network Configuration Elements

A CompoNet Network is a remote I/O system that consists of the following elements.

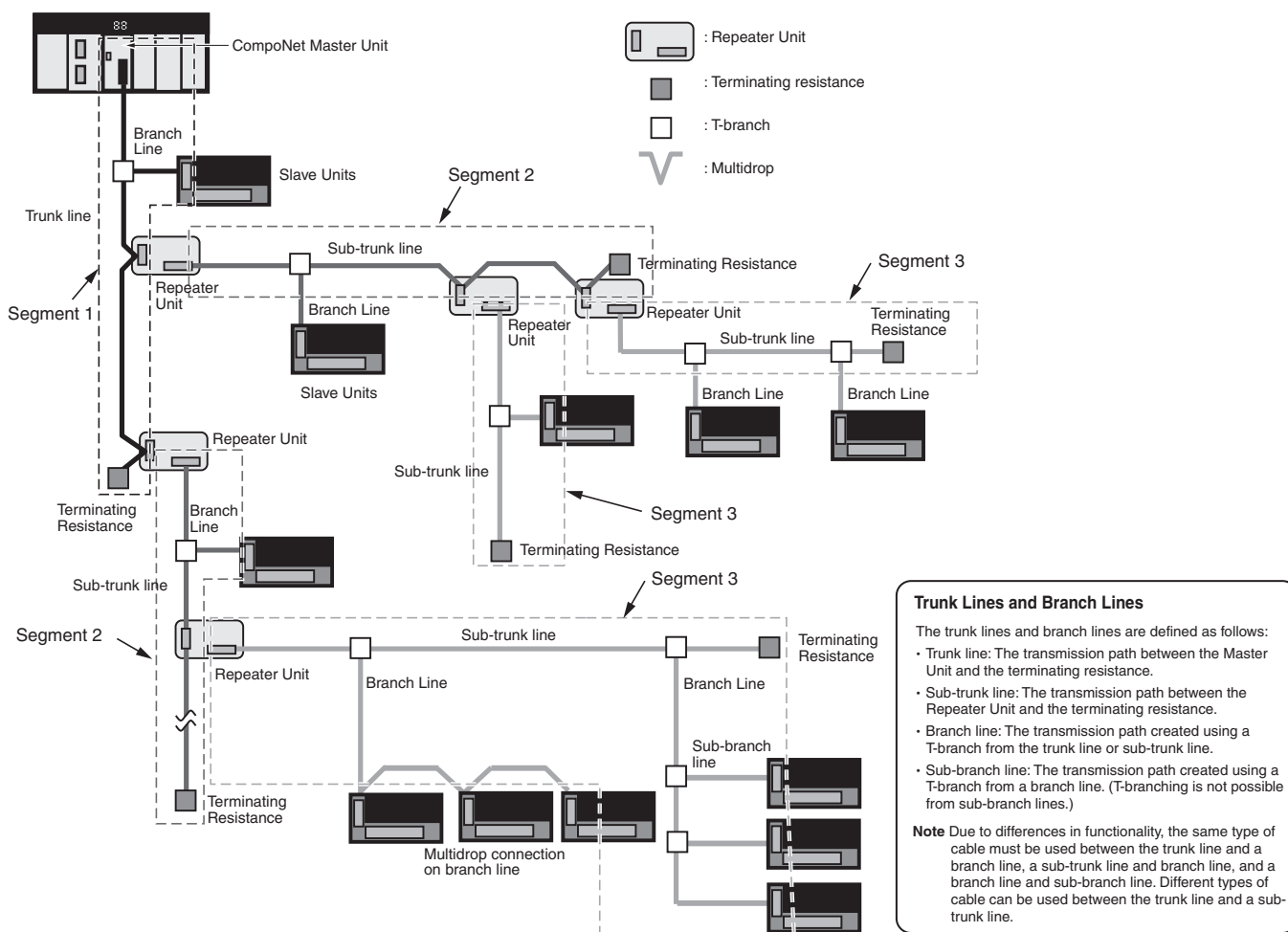

Segment

■ Segment layers

When Repeater Units are used, the CompoNet Network is divided into segments by the Repeater Units.

Each segment is connected to the network, but is isolated electrically.

Three layers of these isolated segments can be configured, called segments 1, 2, and 3, counted in order from the Master Unit.

Repeater Units can be used to add a maximum of two extra segment layers.

Including Repeater Units connected using multidrop connections, a maximum of 64 Repeater Units can be connected in a single network (i.e., to a single Master Unit).

■ Number of Units Per Segment

Within the same segment, you can connect up to 32 slave ports (upstream port on Slave Units or Repeater Units) to one master port (downstream ports on Master Unit or Repeater Unit).

Types of Node Addresses for CompoNet Networks

The following types of node addresses are used when setting node addresses for CompoNet networks.

| Node address type | Address range | Applicable slaves |
|--------------------------------------|---------------|---|
| Word input slave Word mixed slave | 0 to 63 | Input slaves or I/O slaves that are allocated inputs or outputs in 16-point units |
| Word output slave | 0 to 63 | Output slaves that are allocated outputs in 16-point units |
| Bit input slave Bit mixed slave | 0 to 127 | Input slaves or I/O slaves that are allocated inputs or outputs in 2-point units |
| Bit output slave | 0 to 127 | Output slaves that are allocated outputs in 2-point units |
| Repeater Unit | 0 to 63 | Repeater Units |

■ Node address types for mixed slaves are the same as those for input slaves.

- Word input slaves and word mixed slaves have the same node address type.
- Bit input slaves and bit mixed slaves have the same node address type.
- If a Word Input Expansion Unit (XWT-ID16 or XWT-ID08) is connected to a word output slave, it is treated as a mixed slave. The node address type will be a word mixed slave instead of a word output slave.

■ The same node addresses can sometimes be used as long as the node address types are different.

The same node address can be used for different node address types as long as the allocated words or bits do not overlap.

The same node address cannot be used for word mixed slaves and word output slaves because the allocated words overlap. The same thing applies to bit mixed slaves and bit output slaves.

Example 1: You can use a word input slave with a node address of 0 and a word output slave with a node address of 0 at the same time.

Example 2: You can use a word mixed slave with a node address of 1 and a bit mixed slave with a node address of 1 at the same time.

Example 3: You can use a word input slave with a node address of 2 and a Repeater with a node address of 2 at the same time.

■ The same node address cannot be used for slaves with the same node address type.

Example 1: You cannot use two word input slaves with a node address of 1.

Example 2: You cannot use a bit input slave with a node address of 2 and a bit mixed slave with a node address of 2 at the same time.

■ Nodes for which the bit or word allocations overlap cannot be used at the same time.

Example 1: A 64-point word output slave with a node address of 2 is allocated the words for node addresses 2, 3, 4, and 5 for word output slaves. Therefore, word output slaves with node addresses of 3, 4, and 5 cannot be used at the same time.

Example 2: Example 2: A word mixed slave with 32 inputs, 32 outputs, and a node address of 0 uses node addresses 0 and 1 for both word mixed slaves and word output slaves. Therefore, word input slaves, word mixed slaves, and word output slaves with a node address of 1 cannot be used at the same time.

CompoNet Network Specification

Slave Unit I/O information and status information is allocated in the Special I/O Unit memory area or a user-specified area of the CPU Unit to which the Master Unit is mounted.

The area is determined by the unit number of the Master Unit as a Special I/O Unit and by the communications mode number. The user specifies the communications mode number using the CompoNet Support Software. The bits used by Slave Units are determined by the node address for each Slave Unit.

The relationship between communications mode numbers, the number of connected nodes, and the number of points that can be controlled is described next.

| Communications mode number | Mode name | Connectable node addresses | Control points | Memory area | Number of unit numbers used by each Master Unit |
|----------------------------|-----------------------|--|--|---|---|
| 0 | Mode 0 | Word Slave Units: IN0 to IN7 and OUT0 to OUT7 | 128 inputs and 128 outputs (Word Slave Units) | Special I/O Unit Area (First word depends on unit number of Master Unit.) | 2 |
| 1 | Mode 1 | Word Slave Units: IN0 to IN15 and OUT0 to OUT15 | 256 inputs and 256 outputs (Word Slave Units) | | 4 |
| 2 | Mode 2 | Word Slave Units: IN0 to IN31 and OUT0 to OUT31 | 512 inputs and 512 outputs (Word Slave Units) | | 8 |
| 3 | Mode 3 | Word Slave Units: IN0 to IN15 and OUT0 to OUT15 Bit Slave Units: IN0 to IN63 and OUT0 to OUT63 | 256 inputs and 256 outputs (Word Slave Units) 128 inputs and 128 outputs (Word Slave Units) | | 8 |
| 4 | Reserved | --- | --- | --- | --- |
| 5 | Reserved | --- | --- | --- | --- |
| 6 | Reserved | --- | --- | --- | --- |
| 7 | Reserved | --- | --- | --- | --- |
| 8 | Software Setting Mode | Can be set within the following ranges: Word Slave Units: IN0 to IN63 and OUT0 to OUT63 Bit Slave Units: IN0 to IN127 and OUT0 to OUT127 | Can be set within the following ranges: Word Slave Units: 1,024 inputs and 1,024 outputs Bit Slave Units: 256 inputs and 256 outputs | Can be allocated anywhere in the CIO, DM, WR, or HR Area. Status and parameters are allocated in the Special I/O Unit Area. Note: Status and parameters are allocated in the Special I/O Unit Area. | 1 |
| 9 | Reserved | --- | --- | --- | --- |

- Note 1.** In a CompoNet Network, Word Slave Units have 16 bits per node address. Bit Slave Units have two bits allocated per node address.
2. Do not use the reserved communications mode numbers (4 to 7 and 9). A communications mode setting error (H4 at the 7-segment LED indicator) will occur if any of these mode numbers is set.
 3. CompoNet Network for CompoNet Gateway Unit, refer to the CompoNet Gateway Unit page.

Communications and I/O Power Supply Wiring

The following power supplies are required to operate the CompoNet Network.

- Communications power supply: Used for communications with individual Units and for internal circuit operations of Units.
- I/O power supply: Used for I/O operations for Units with external I/O.

The method for supplying communications power and I/O power depends on the types of cable and Slave Unit that are used. The differences are shown in the following table.

| Power supply method | Cable types | Communications power supply | I/O power supply |
|----------------------|------------------------------------|--|---|
| Multi-power supply | Flat Cable I, II Round Cable II | Supplied through the Communications Cable by supplying power to the Master Unit. | Supplied to individual Units separately from the communications power supply. |
| | Round Cable I | Supplied to Units individually | |
| Network power supply | Flat Cable I, II Round Cable II | The communications power supply and the I/O power supply are provided together through Communications Cable. | |
| | Round Cable I | Cannot be used. | |

Connection Locations for Communications Power Supply

■ Round Cable II Flat Cable

Connect a 24-VDC power supply to the Master Unit's communications power supply connector (BS+ and BS-). This provides communications power to each Slave Unit and Repeater Unit connected by Round Cable II or Flat Cable. Connect only one communications power supply for the trunk line. The cable between the communications power supply and the communications power supply connector must be no longer than 3 m.

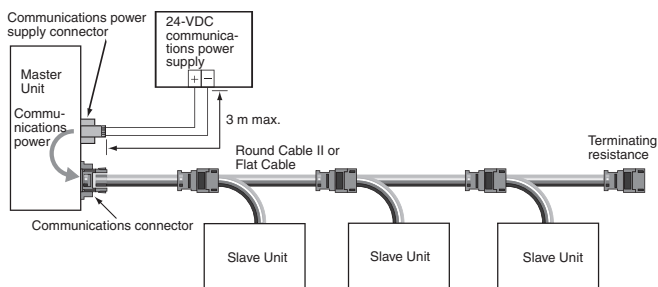

When Repeater Units are used, communications power to sub-trunk lines is supplied by the downstream port communications power supply connectors (BS+ and BS-) of the Repeater Units. The cable between the communications power supply and the communications power supply connector must be no longer than 3 m.

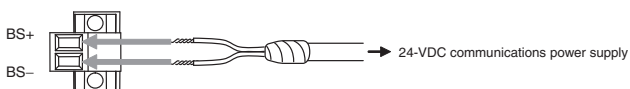
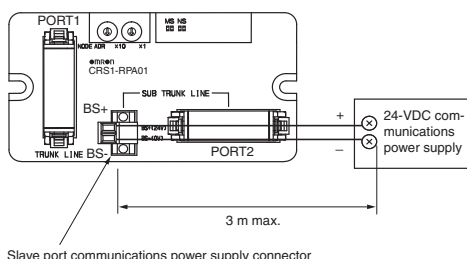

■ Round Cable I

A 24-VDC power supply is connected individually to each Slave Unit. Power does not need to be supplied to the Master Unit.

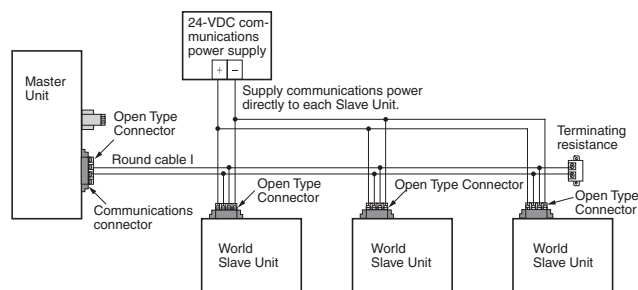

Before connecting the power supply, first connect a DCN4-TB4 Open Type Connector to the communications connector to convert it to a screw terminal block.

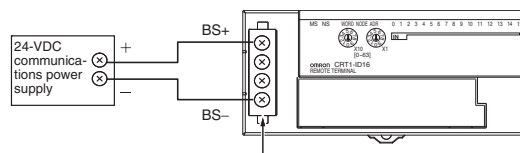

Connect an Open Type Connector here.

When using a Repeater Unit, supply power through the BS+ and BS- terminals of the Repeater Unit's PORT1 connector.

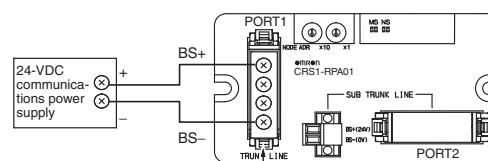

Connect an Open Type Connector here.

● Ferrules

The following ferrules are recommended for the communications power supply cable.

| Model | Applicable wire size | Crimping tool | Manufacturer |
|-----------------|----------------------|--|---------------------------|
| A10, 5-10 WH | 0.5 mm/AWG20 | CRIMPFOX UD6 (product number 1204436) or the CRIMPFOX ZA3 Series | Phoenix Contact K.K. |
| H 0.5/16 orange | 0.5 mm/AWG20 | Crimper PZ 1.5 (Product number 900599) | Weidmuellr Japan Co.,Ltd. |

The following screwdriver is recommended for removing ferrules.

| Model | Manufacturer |
|----------|-------------------|
| XW4Z-00C | OMRON Corporation |

Restrictions

The following restrictions apply when supplying communications power through Round Cable II or Flat Cable.

- The communications power supply can be connected at only one location for the trunk line and one location each for the sub-trunk lines.
- Communications power to the trunk line can be supplied only through the communications power supply connector on the Master Unit. Communications power to a sub-trunk line can be supplied only through the slave port communications power supply connector on the Repeater Unit. Communications power cannot be supplied at any other location.

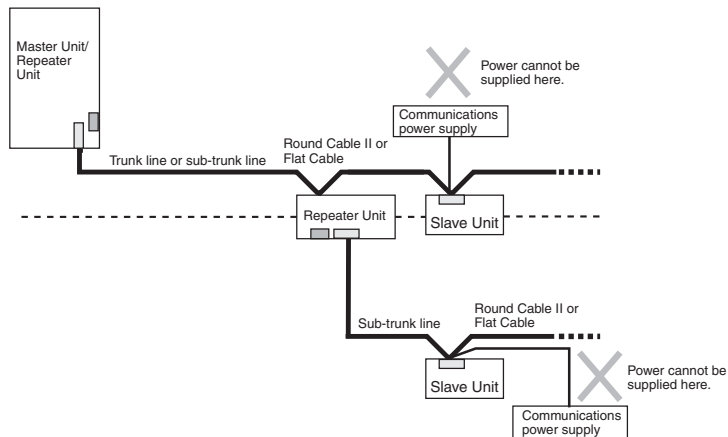
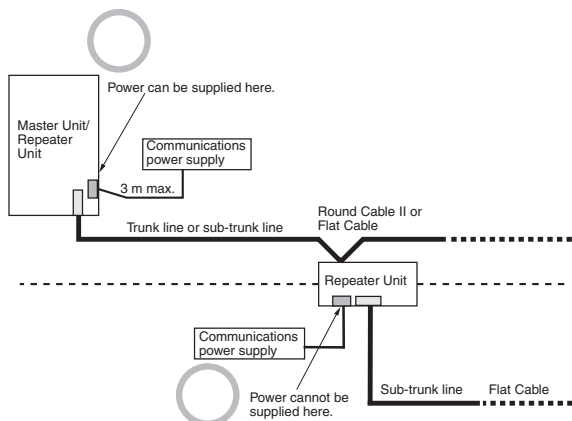

- Use separate power supplies for the Master Unit trunk line and for each sub-trunk line (i.e., for the trunk line on the Master side of the Repeater Unit and the sub-trunk line on the Slave side).

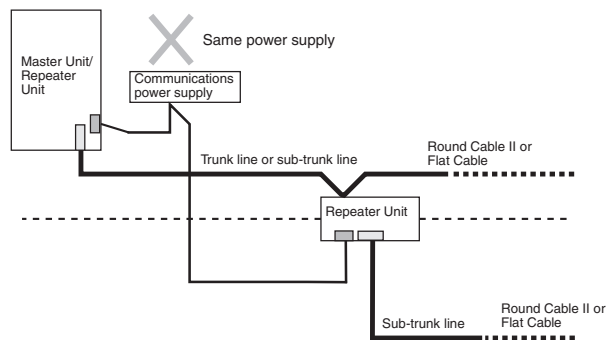
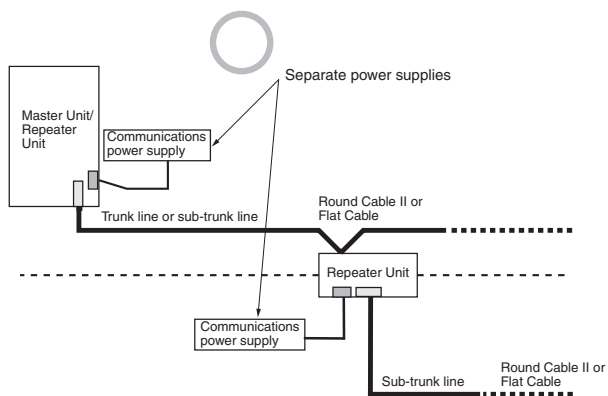

Transmission quality will not be maintained and communications errors may occur if this restriction is not observed.

Connecting External I/O for Slave Units

Connecting to e-CON Connector Terminals

For Slave Units with e-CON connector terminals, a special cable connector must be attached to an external device cable. Follow the procedure below to attach the connector to the cable.

■ Checking the Cable Connector and Cable Wire Size

The wire size and sheath diameter of applicable cables depend on the type of cable connector. Use the following table to check that the cable connector and external device cable wire size and sheath diameter are compatible.

● Tyco Electronics Connectors

| Model | Housing color | Applicable wire range | |
|-------------|---------------|--|---|
| 3-1473562-4 | Orange | sheath outer diameter: 0.9 to 1.0 mm | Cross-sectional area: 0.08 to 0.5 mm ² |
| 1-1473562-4 | Red | sheath outer diameter: 0.9 to 1.0 mm | |
| 1473562-4 | Yellow | sheath outer diameter: 1.0 to 1.15 mm | |
| 2-1473562-4 | Blue | sheath outer diameter: 1.15 to 1.35 mm | |
| 4-1473562-4 | Green | sheath outer diameter: 1.35 to 1.60 mm | |

● Sumitomo 3M Connectors

| Model | Housing color | Applicable wire range |
|------------------|---------------|---|
| 37104-3101-000FL | Red | AWG26 (0.14 mm ²) to AWG24 (0.2 mm ²), sheath outer diameter: 0.8 to 1.0 mm |
| 37104-3122-000FL | Yellow | AWG26 (0.14 mm ²) to AWG24 (0.2 mm ²), sheath outer diameter: 1.0 to 1.2 mm |
| 37104-3163-000FL | Orange | AWG26 (0.14 mm ²) to AWG24 (0.2 mm ²), sheath outer diameter: 1.2 to 1.6 mm |
| 37104-2124-000FL | Green | AWG22 (0.3 mm ²) to AWG20 (0.5 mm ²), sheath outer diameter: 1.0 to 1.2 mm |
| 37104-2165-000FL | Blue | AWG22 (0.3 mm ²) to AWG20 (0.5 mm ²), sheath outer diameter: 1.2 to 1.6 mm |
| 37104-2206-000FL | Gray | AWG22 (0.3 mm ²) to AWG20 (0.5 mm ²), sheath outer diameter: 1.6 to 2.0 mm |

● OMRON Connectors

| Model | Specification | Applicable wire range |
|-----------|-------------------|---|
| XN2A-1470 | Spring clamp type | Stranded wire AWG28 (0.08 mm ²) to AWG20 (0.5 mm ²), sheath outer diameter: 1.5 mm max. |

Connecting to MIL Connector Terminals

Use any of the following methods to connect to a MIL connector.

- Use an OMRON MIL Cable.
- Pressure-weld a Flat Cable to a MIL Socket.
- Pressure-weld a loose-wire cable to a MIL connector.

■ Using OMRON MIL Cable

- Connecting Relay Terminals

The MIL Cables for connecting OMRON Relay Terminals are shown in the following table. Select the appropriate Cable depending on the combination of Remote I/O Terminals and Relay Terminals that are used.

CRT1-□D16ML(-1)

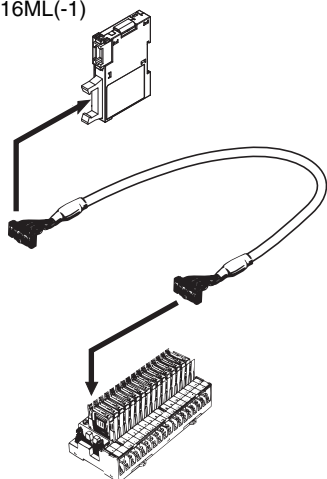

CRT1-□D32ML(-1)

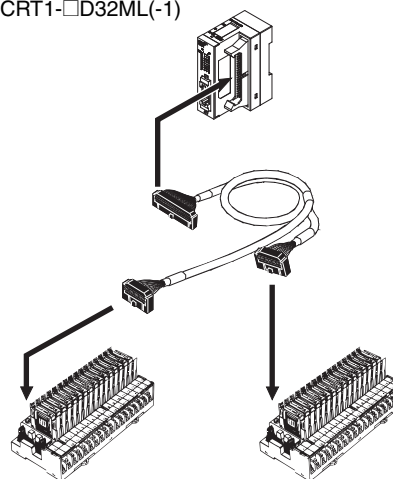

| Slave model | MIL Cable model | Connected Relay Terminal | Remarks |
|----------------------------------|--|---|--|
| CRT1-VID16ML | XW2Z-RI□C | G7TC-ID16 G7TC-IA16 | --- |
| CRT1-VOD16ML/ XWT-VOD16ML | XW2Z-RO□C | G7TC-OC16/OC08 G7OD-SOC16/VSOC16 G7OD-FOM16/VFOM16 G7OA-ZOC16-3 G7OD-SOC08 G7OR-SOC08 | --- |
| CRT1-VOD16ML-1/ XWT-VOD16ML-1 | XW2Z-RI□C | G7TC-OC16-1 | --- |
| | XW2Z-RO□C | G7OD-SOC16-1 G7OD-FOM16-1 G7OA-ZOC16-4 | |
| CRT1-VID32ML | XW2Z-RI50-25-D1 (50 cm) XW2Z-RI75-50-D1 (75 cm) | G7TC-ID16 G7TC-IA16 | --- |
| CRT1-VOD32ML | XW2Z-RO50-25-D1 (50 cm) XW2Z-RO75-50-D1 (75 cm) | G7TC-OC16/OC08 G7OD-SOC16/VSOC16 G7OD-FOM16/VFOM16 G7OA-ZOC16-3 G7OD-SOC08 G7OR-SOC08 | --- |
| CRT1-VOD32ML-1 | XW2Z-RO50-25-D1 (50 cm) XW2Z-RO75-50-D1 (75 cm) | G7OD-SOC16-1 G7OD-FOM16-1 G7OA-ZOC16-4 | --- |
| | XW2Z-RI50-25-D1 (50 cm) XW2Z-RI75-50-D1 (75 cm) | G7TC-OC16-1 | |
| CRT1-VMD32ML | XW2Z-RM50-25-D1 (50 cm) XW2Z-RM75-50-D1 (75 cm) | Inputs: G7TC-ID16 G7TC-IA16 Outputs: G7TC-OC16/OC08 G7OD-SOC16/VSOC16 G7OD-FOM16/VFOM16 G7OA-ZOC16-3 G7OD-SOC08 G7OR-SOC08 | Inputs and outputs are distinguished by color. Input tube color: Red Output tube color: Yellow |
| CRT1-VMD32ML-1 | XW2Z-RM50-25-D2 (50 cm) XW2Z-RM75-50-D2 (75 cm) | Inputs: G7OA-ZIM16-5 G7OD-SOC16-1 G7OD-FOM16-1 G7OA-ZOC16-4 | Inputs and outputs are distinguished by color. Input tube color: Red Output tube color: Yellow |

Note: Including models whose production were discontinued.

- Connecting to a Connector-Terminal Block Conversion Unit
The following Connector-Terminal Block Conversion Units are available.
For details, refer to the *SYSMAC Selection Guide* (Cat. No. X066).

| Type | Series |
|---------------------------------|--------|
| Slim | XW2D |
| Through-type | XW2B |
| With common terminal | XW2C |
| Three-tier with common terminal | XW2E |
| Screw-less clamp terminals | XW2F |
| e-CON connector | XW2N |

- Connecting Loose Wires to Devices
The following table shows the Cables available when the Slave Unit has a MIL connector and the other device has loose wires. Use these Cables as needed.

| Slave model | MIL Cable model | Remarks |
|------------------------------|---|---|
| CRT1-V□D16ML/ XWT-V□D16ML | XW2Z-RA200C (2 m) XW2Z-RA500C (5 m) | Loose wire size: AWG24 Loose wires are cut. |
| | XW2Z-RY100C (1 m) XW2Z-RY150C (1.5 m) XW2Z-RY200C (2 m) XW2Z-RY300C (3 m) XW2Z-RY500C (5 m) | Forked terminals are attached to the loose wires. Forked terminal: 161071-M2 (JST Mfg. Co., Ltd.) |
| CRT1-V□D32ML | XW2Z-RA200C-D1 (2 m) XW2Z-RA500C-D1 (5 m) | Loose wire size: AWG28 Loose wires are cut. |
| | XW2Z-RY100C-D1 (1 m) XW2Z-RY200C-D1 (2 m) XW2Z-RY500C-D1 (5 m) | Forked terminals are attached to the loose wires. Forked terminal: 161071-M2 (JST Mfg. Co., Ltd.) |
| CRT1-VDA02ML | 10 pins | Indicated cable is not available |
| CRT1-VAD04ML | 16 pins | |

■ Pressure-welding a Flat Cable to a MIL Socket

To make your own connecting cable by pressure-welding the flat cable to the MIL socket, use the components shown in the table below and follow the directions.

- Required Components

| Number of connector pins | Model | |
|--------------------------|---------------------|-------------|
| 10 pins | No polarity guide | XG4M-1031-T |
| | Uses polarity guide | XG4M-1030-T |
| 16 pins | XG4M-1630-T | |
| 20 pins | XG4M-2030-T | |
| 40 pins | XG4M-4030-T | |

■ Pressure-welding a Loose-wire Cable to a MIL Connector

To prepare a connecting cable by pressure-welding a loose-wire cable to a MIL connector, assemble the connector from the components shown in the following table.

• 10-pin Cable

| Component | | Wire size: AWG24 | Wire size: AWG28 to AWG26 |
|--------------|---------------------|------------------|------------------------------|
| Socket | No polarity guide | XG5M-1031-N | XG5M-1034-N |
| | Uses polarity guide | XG5M-1032-N | XG5M-1035-N |
| Semi-cover * | | XG5S-0501 | |

• 16-pin Cable

| Component | | Wire size: AWG24 | Wire size: AWG28 to AWG26 |
|--------------|--|------------------|------------------------------|
| Socket | | XG5M-1632-N | XG5M-1635-N |
| Semi-cover * | | XG5S-0801 | |

• 20-pin Cable

| Component | | Wire size: AWG24 | Wire size: AWG28 to AWG26 |
|--------------|--|------------------|------------------------------|
| Socket | | XG5M-2032-N | XG5M-2035-N |
| Semi-cover * | | XG5S-1001 | |
| Hood Cover | | XG5S-2012 | |

• 40-pin Cable

| Component | | Wire size: AWG24 | Wire size: AWG28 to AWG26 |
|--------------|--|------------------|------------------------------|
| Socket | | XG5M-4032-N | XG5M-4035-N |
| Semi-cover * | | XG5S-2001 | |
| Hood Cover | | XG5S-4022 | |

* Two Semi-covers are required per connector.

For details on individual components, refer to the *Connectors Group Catalog* (Cat. No. G015).

Connecting to Screw-less Clamp Terminal Blocks

For Slave Units with screw-less clamp terminal blocks, the terminal blocks can be easily wired by inserting pin terminals. Follow the procedure below to connect the external device cable to a screw-less clamp terminal block.

■ Applicable Pin Terminals

When wiring an external device cable to a screw-less clamp terminal block, special pin terminals must be placed on the cable wires. The applicable pin terminals are listed in the following table.

| Name | Applicable wire size | Crimp tool | Manufacturer |
|----------------|-----------------------------|------------|---------------------------|
| H0.5/14 orange | 0.5 mm ² /AWG20 | PZ6 roto | Weidmuellr Japan Co.,Ltd. |
| H0.75/14 white | 0.75 mm ² /AWG18 | | |
| H1.5/14 red | 1.5 mm ² /AWG16 | | |

The pin terminal conductor should be about 8 to 10 mm in length.

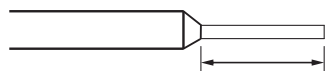

Conductor length: 8 to 10 mm

Ordering Information

| | |
|---|-----|
| CompoNet Master Units..... | 106 |
| CompoNet Master Board | 106 |
| CompoNet Gateway Units..... | 106 |
| ■ CompoNet Gateway Unit for CC-Link | 106 |
| CompoNet Slave Units..... | 106 |
| ■ Word Slave Units | 106 |
| ■ Bit Slave Units..... | 110 |
| ■ Repeater Unit..... | 110 |
| ■ SmartSlice GRT1 Series | 111 |
| ■ Sensor Communications Unit | 112 |
| ■ Inverter..... | 112 |
| ■ Software..... | 112 |
| Peripheral Devices | 113 |
| ■ Communications Cables | 113 |
| ● For Flat Cable I..... | 113 |
| ● For Round Cable I..... | 114 |
| ● For Round Cable II..... | 114 |
| ■ Mounting Bracket..... | 114 |

● International Standards

- The standards are abbreviated as follows: U: UL, U1: UL (Class I Division 2 Products for Hazardous Locations), C: CSA, UC: cULus, UC1: cULus (Class I Division 2 Products for Hazardous Locations), CU: cUL, N: NK, L: Lloyd, CE: EC Directives, and UK: UKCA.
- Contact your OMRON representative for further details and applicable conditions for these standards.

● EC Directives

The EC Directives applicable to PLCs include the EMC Directives and the Low Voltage Directive. OMRON complies with these directives described below.

● EMC Directives

Applicable Standards

EMI : EN61131-2

EN61000-6-4

EMS: EN61131-2

EN61000-6-2

PLCs are electrical devices that are incorporated in machines and manufacturing installations. OMRON PLCs conform to the related EMC standards so that the devices and machines into which they are built can more easily conform to EMC standards. The actual PLCs have been checked for conformity to EMC standards. Whether these standards are satisfied for the actual system, however, must be checked by the customer.

EMC-related performance will vary depending on the configuration, wiring, and other conditions of the equipment or control panel in which the PLC is installed. The customer must, therefore, perform final checks to confirm that the overall machine or device conforms to EMC standards.

Note: The applicable EMS standards depend on the product.



● Low Voltage Directive

Applicable Standard: EN61131-2

Devices that operate at voltages from 50 to 1,000 VAC or 75 to 150 VDC must satisfy the appropriate safety requirements. With PLCs, this applies to Power Supply Units and I/O Units that operate in these voltage ranges.

These Units have been designed to conform to EN61131-2, which is the applicable standard for PLCs.

CompoNet Master Units

| Name | Appearance | Specifications | | Number of unit numbers allocated | Power consumption (A) | | | Model | Standards |
|------------------------|---|---|---|----------------------------------|-----------------------|-------------|-------------|------------|-----------------|
| | | Type of communications | Maximum number of I/O points per Master Unit | | 5-V system | 24-V system | 26-V system | | |
| CJ1 Special I/O Unit * |  | <ul style="list-style-type: none"> Remote I/O communications Message communications | Word Slave Units: 1,024 inputs and 1,024 outputs (2,048 I/O points total) Bit Slave Units: 256 inputs and 256 outputs (512 I/O points total) | 1, 2, 4, or 8 | 0.4 | --- | | CJ1W-CRM21 | CE, U, U1, L, N |
| CS1 Special I/O Unit * |  | <ul style="list-style-type: none"> Remote I/O communications Message communications | Word Slave Units: 1,024 inputs and 1,024 outputs (2,048 I/O points total) Bit Slave Units: 256 inputs and 256 outputs (512 I/O points total) | 1, 2, 4, or 8 | 0.4 | | --- | CS1W-CRM21 | CE, U, U1, L, N |

* These Units are also available with a DCN-TB4 Terminal Conversion Adapter included in the package. Add "(-B)" to the end of the model number to receive the Adapter as well.

CompoNet Master Board

| Name | Appearance | Specification | Model | Standards |
|--------------|---|--------------------|-------------|-----------|
| PCI Bus type |  | PCI bus Rev.2.2 5V | 3G8F7-CRM21 | CE |

CompoNet Gateway Units

CompoNet Gateway Unit for CC-Link

| Name | Appearance | Model | Standards |
|-----------------------------------|---|----------|-----------|
| CompoNet Gateway Unit for CC-Link |  | GQ-CRM21 | CE, UI, C |



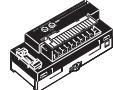

CompoNet Slave Units

Word Slave Units

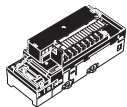

Digital I/O Slave Units

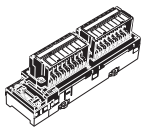
| Name | Appearance | Specifications | | | Model | Standards |
|-------------------------------|---|----------------|-------------|--------------|---------------|-----------------|
| Two-tier Screw Terminal Block |  | Inputs | 8 inputs | NPN | CRT1-ID08 | CE, U, U1, N |
| | | | | PNP | CRT1-ID08-1 | |
| | | Outputs | 8 outputs | NPN | CRT1-OD08 | |
| | | | | PNP | CRT1-OD08 | |
| | | Inputs | 16 inputs | NPN | CRT1-ID16 * | CE, U, U1, C, N |
| | | | | PNP | CRT1-ID16-1 * | |
| | | Outputs | 16 outputs | NPN | CRT1-OD16 * | |
| | | | | PNP | CRT1-OD16-1 * | |
| Inputs/Outputs | 8 inputs/8 outputs | NPN | CRT1-MD16 | CE, U, U1, N | | |
| | | PNP | CRT1-MD16-1 | | | |

* These Units are also available with a DCN-TB4 Terminal Conversion Adapter included in the package. Add "(-B)" to the end of the model number to receive the Adapter as well.

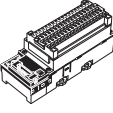

| Name | Appearance | Specifications | | | Model | Standards | | |
|---|---|----------------|-----------------------|----------|---|--|-----------------|----------------|
| Screw Terminal Block with Relay Outputs |  | Outputs | 8 outputs | Contacts | --- | CRT1-ROS08 | CE, UC, UC1, N | |
| | | | 16 outputs | | | CRT1-ROS16 | | |
| Screw Terminal Block with SSR Outputs |  | Outputs | 8 outputs | SSR | | CRT1-ROF08 | --- | |
| | | | 16 outputs | | | CRT1-ROF16 | | |
| Three-tier Screw Terminal Block |  | Inputs | 8 inputs | NPN | Without Short-circuit and Disconnected Line Detection | CRT1-ID08TA | CE, UC, UC1 | |
| | | | | PNP | | CRT1-ID08TA-1 | | |
| | | Outputs | 8 outputs | NPN | | CRT1-OD08TA | | |
| | | | | PNP | | CRT1-OD08TA-1 | | |
| | | Inputs | 16 inputs | NPN | | CRT1-ID16TA | | |
| | | | | PNP | | CRT1-ID16TA-1 | | |
| | | Outputs | 16 outputs | NPN | | CRT1-OD16TA | | |
| | | | | PNP | | CRT1-OD16TA-1 | | |
| | | Inputs/Outputs | 8 inputs/8 outputs | NPN | | CRT1-MD16TA | | |
| | | | | PNP | | CRT1-MD16TA-1 | | |
| | | Inputs | 8 inputs | NPN | | With Short-circuit and Disconnected Line Detection | | CRT1-ID08TAH |
| | | | | PNP | | | | CRT1-ID08TAH-1 |
| | | Outputs | 8 outputs | NPN | | | | CRT1-OD08TAH |
| | | | | PNP | | | | CRT1-OD08TAH-1 |
| Inputs | 16 inputs | NPN | CRT1-ID16TAH | | | | | |
| | | PNP | CRT1-ID16TAH-1 | | | | | |
| Outputs | 16 outputs | NPN | CRT1-OD16TAH | | | | | |
| | | PNP | CRT1-OD16TAH-1 | | | | | |
| Inputs/Outputs | 8 inputs/8 outputs | NPN | CRT1-MD16TAH | | | | | |
| | | PNP | CRT1-MD16TAH-1 | | | | | |
| e-CON Connectors |  | Inputs | 16 inputs | NPN | Without Short-circuit and Disconnected Line Detection | | CRT1-ID16S | CE, UC, UC1 |
| | | | | PNP | | | CRT1-ID16S-1 | |
| | | Outputs | 16 outputs | NPN | | | CRT1-OD16S | |
| | | | | PNP | | | CRT1-OD16S-1 | |
| | | Inputs/outputs | 8 inputs /8 outputs | NPN | | CRT1-MD16S | | |
| | | | | PNP | | CRT1-MD16S-1 | | |
| | | Inputs | 32 inputs | NPN | | CRT1-ID32S | | |
| | | | | PNP | | CRT1-ID32S-1 | | |
| | | Outputs | 32 outputs | NPN | | CRT1-OD32S | | |
| | | | | PNP | | CRT1-OD32S-1 | | |
| | | Inputs/outputs | 16 inputs /16 outputs | NPN | | CRT1-MD32S | | |
| | | | | PNP | | CRT1-MD32S-1 | | |
| | | Inputs | 16 inputs | NPN | | With Short-circuit and Disconnected Line Detection | CRT1-ID16SH | |
| | | | | PNP | | | CRT1-ID16SH-1 | |
| | | Outputs | 16 outputs | NPN | | | CRT1-OD16SH | |
| | | | | PNP | | | CRT1-OD16SH-1 | |
| | | Inputs/outputs | 8 inputs /8 outputs | NPN | | | CRT1-MD16SH | |
| | | | | PNP | | | CRT1-MD16SH-1 | |
| Inputs | 32 inputs | NPN | CRT1-ID32SH | | | | | |
| | | PNP | CRT1-ID32SH-1 | | | | | |
| Outputs | 32 outputs | NPN | CRT1-OD32SH | | | | | |
| | | PNP | CRT1-OD32SH-1 | | | | | |
| Inputs/outputs | 16 inputs /16 outputs | NPN | CRT1-MD32SH | | | | | |
| | | PNP | CRT1-MD32SH-1 | | | | | |
| e-CON Connectors |  | Inputs | 8 inputs | NPN | Without Short-circuit and Disconnected Line Detection | | CRT1-VID08S * | CE, UC, UC1 |
| | | | | PNP | | | CRT1-VID08S-1 * | |
| | | Outputs | 8 outputs | NPN | | | CRT1-VOD08S * | |
| | | | | PNP | | | CRT1-VOD08S-1 * | |

* These Units are also available with a DCN-TB4 Terminal Conversion Adapter included in the package. Add "(-B)" to the end of the model number to receive the Adapter as well.

| Name | Appearance | Specifications | | | | Model | Standards |
|-----------------------|---|----------------|----------------------|-----|-----|------------------|----------------|
| MIL Connector |  | Inputs | 16 inputs | NPN | --- | CRT1-VID16ML * | CE, UC, UC1, N |
| | | | | PNP | | CRT1-VID16ML-1 * | |
| | | Outputs | 16 outputs | NPN | | CRT1-VOD16ML * | |
| | | | | PNP | | CRT1-VOD16ML-1 * | |
| MIL Connector |  | Inputs | 32 inputs | NPN | --- | CRT1-VID32ML * | CE, UC, UC1, N |
| | | | | PNP | | CRT1-VID32ML-1 * | |
| | | Outputs | 32 outputs | NPN | | CRT1-VOD32ML * | |
| | | | | PNP | | CRT1-VOD32ML-1 * | |
| | | Inputs/Outputs | 16 inputs/16 outputs | NPN | | CRT1-VMD32ML * | |
| | | | | PNP | | CRT1-VMD32ML-1 * | |
| Clamp Terminal Blocks |  | Inputs | 8 inputs | NPN | --- | CRT1-ID08SL | U, CE, N |
| | | | | PNP | | CRT1-ID08SL-1 | |
| | | Outputs | 8 outputs | NPN | | CRT1-OD08SL | |
| | | | | PNP | | CRT1-OD08SL-1 | |
| | | Inputs | 16 inputs | NPN | | CRT1-ID16SL | |
| | | | | PNP | | CRT1-ID16SL-1 | |
| | | Outputs | 16 outputs | NPN | | CRT1-OD16SL | |
| | | | | PNP | | CRT1-OD16SL-1 | |
| | | Inputs/Outputs | 8 inputs/8 outputs | NPN | | CRT1-MD16SL | |
| | | | | PNP | | CRT1-MD16SL-1 | |

* These Units are also available with a DCN-TB4 Terminal Conversion Adapter included in the package. Add "(-B)" to the end of the model number to receive the Adapter as well.

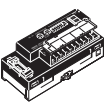
● Analog I/O Slave Units

| Name | Appearance | Specifications | | Model | Standards |
|------------------------|---|----------------|-----------|--------------|-----------------|
| Analog I/O Slave Units |  | Analog inputs | 4 inputs | CRT1-AD04 * | CE, U, U1, C, N |
| | | Analog outputs | 2 outputs | CRT1-DA02 * | |
| MIL Connector Type |  | Analog inputs | 4 inputs | CRT1-VAD04ML | CE, UC, UC1 |
| | | Analog outputs | 2 outputs | CRT1-VDA02ML | |
| e-CON Connector Type |  | Analog inputs | 4 inputs | CRT1-VAD04S | |
| | | Analog outputs | 2 outputs | CRT1-VDA02S | |

* These Units are also available with a DCN-TB4 Terminal Conversion Adapter included in the package. Add "(-B)" to the end of the model number to receive the Adapter as well.

● Temperature Input Units

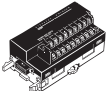

| Name | Appearance | Specifications | | | Model | Standards |
|-------------------------|---|---------------------------------------|----------|---|------------|----------------|
| Temperature Input Units |  | Thermocouple Input | 4 inputs | Switchable between (R, S, K, J, T, E, B, N, L, U, W, PL2) | CRT1-TS04T | CE, UC, UC1, N |
| | | Platinum-resistance thermometer input | | PT100 (-200 to 850°C) PT100 (-200 to 2000°C) | CRT1-TS04P | |

● Expansion Units

| Name | Appearance | Specifications | | | | Model | Standards |
|-----------------|---|----------------|------------|-----|---|------------|--------------------|
| Expansion Units |  | Inputs | 8 inputs | NPN | One Expansion Unit can be mounted to one CRT1-ID16(-1), CRT1-OD16(-1), CRT1-ROS16, or CRT1-ROF16 Digital I/O Slave. | XWT-ID08 | CE, UC, UC1, N |
| | | | | PNP | | XWT-ID08-1 | |
| | | Outputs | 8 outputs | NPN | | XWT-OD08 | CE, UC, UC1, N, UK |
| | | | | PNP | | XWT-OD08-1 | |
| | | Inputs | 16 inputs | NPN | | XWT-ID16 | CE, UC, UC1, N |
| | | | | PNP | | XWT-ID16-1 | |
| | | Outputs | 16 outputs | NPN | | XWT-OD16 | CE, UC, UC1, N, UK |
| | | | | PNP | | XWT-OD16-1 | |

■ Bit Slave Units

● Compact Connectors

| Name | Appearance | Specifications | | | Model | Standards |
|--------------------|---|----------------|--------------------|-----|----------------|-----------|
| Compact Connectors |  | Inputs | 2 inputs | NPN | CRT1B-ID02JS | CE |
| | | | 2 outputs | PNP | CRT1B-ID02JS-1 | |
| | | Outputs | 2 inputs | NPN | CRT1B-OD02JS | |
| | | | 2 outputs | PNP | CRT1B-OD02JS-1 | |
| | | Inputs/Outputs | 1 input/1 output | NPN | CRT1B-MD02JS | |
| | | | 1 input/1 output | PNP | CRT1B-MD02J-1 | |
| |  | Inputs | 4 inputs | NPN | CRT1B-ID04JS | |
| | | | 4 outputs | PNP | CRT1B-ID04JS-1 | |
| | | Outputs | 4 inputs | NPN | CRT1B-OD04JS | |
| | | | 4 outputs | PNP | CRT1B-OD04JS-1 | |
| | | Inputs/Outputs | 2 inputs/2 outputs | NPN | CRT1B-MD04JS | |
| | | | 2 inputs/2 outputs | PNP | CRT1B-MD04JS-1 | |
| e-CON connectors |  | Inputs | 2 inputs | NPN | CRT1B-ID02S | CE, U |
| | | | 2 inputs | PNP | CRT1B-ID02S-1 | |
| | | Outputs | 2 outputs | NPN | CRT1B-OD02S | |
| | | | 2 outputs | PNP | CRT1B-OD02S-1 | |

■ Repeater Unit

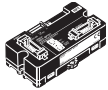
| Name | Appearance | Specifications | Model | Standards |
|---------------|---|---|--------------|-----------------|
| Repeater Unit |  | <p>A sub-trunk line can be connected downstream (for trunk-branch line configuration) or further branching is enabled downstream (for configurations with no wiring restrictions) in the same way as for a Master Unit.</p> <p>A Repeater Unit can be used to branch the trunk line and increase the number of connected Units, as well as to extend the length of the communications line.</p> | CRS1-RPT01 * | CE, U, U1, L, N |





* These Units are also available with a DCN-TB4 Terminal Conversion Adapter included in the package. Add "(-B)" to the end of the model number to receive the Adapter as well.

■ SmartSlice GRT1 Series



● CompoNet Communications Unit

| Name | Appearance | Specifications | Model | Standards |
|-----------------------------|---|---|----------|------------|
| CompoNet Communication Unit |  | Up to 64 Slice I/O Units can be connected (Inputs: 32 bytes maximum, Output: 32 bytes maximum) | GRT1-CRT | CE, UC1, L |

● Slice I/O Units

| Name | Appearance | Specifications | Model | Standards | |
|--|---|---|--|------------|---------------|
| Slice I/O Units | Digital I/O Units |  | 4 inputs NPN | GRT1-ID4 | CE, UC1, L, N |
| | | | 4 inputs PNP | GRT1-ID4-1 | |
| | | | 4 outputs NPN | GRT1-OD4 | |
| | | | 4 outputs PNP | GRT1-OD4-1 | |
| | | | 8 inputs NPN | GRT1-ID8 | CE, UC, L |
| | | | 8 inputs PNP | GRT1-ID8-1 | |
| | | | 8 outputs NPN | GRT1-OD8 | |
| | | | 8 outputs PNP | GRT1-OD8-1 | |
| | | | Relay Outputs 2 points | GRT1-ROS2 | CE, UC1, L, N |
| | | | AC Input 4 points | GRT1-IA4-1 | CE, UC1, L |
| | GRT1-IA4-2 | | | | |
| | Analog I/O Units |  | Analog inputs (current/voltage) | GRT1-AD2 | CE, UC1, L |
| | | | Analog outputs (current) | GRT1-DA2C | |
| | | | Analog output (voltage) | GRT1-DA2V | |
| | Temperature Input (Resistance Thermometers) |  | Temperature input (Resistance thermometer:Pt100) 2 points | GRT1-TS2P | CE, UC1, L |
| | | | Temperature input (Resistance thermometer:Pt1000) 2 points | GRT1-TS2PK | |
| | | | Thermocouple Input 2 points | GRT1-TS2T | CE, UC, L |
| | Counter Units |  | Counter inputs: 1, External outputs: 1 NPN | GRT1-CT1 | CE, UC, L |
| Counter inputs: 1, External outputs: 1 PNP | | | GRT1-CT1-1 | | |

● System Units

| Name | Appearance | Specifications | Model | Standards | |
|--------------|---|---|--|---------------|---------------|
| System Units | Turnback Units |  | Right Turnback Unit (Mounts to the right side of Slice I/O Terminal.) | GRT1-TBR | CE, UC1, L, N |
| | | | Left Turnback Unit (Mounts to the left side of Slice I/O Terminal. Can supply power to I/O Units.) | GRT1-TBL | |
| | Turnback Cable *1 | --- | 1 m | GCN2-100 | UC, CE, L, N |
| | I/O Power Feed Unit |  | Use when the total current consumption of the I/O Power Supply exceeds 4 A, or to make the I/O Power Supply a separate system. | GRT1-PD2 | CE, UC1, L, N |
| | | | | GRT1-PD2G | |
| | | | | GRT1-PD8 | CE, UC, L |
| | | | | GRT1-PD8-1 | |
| End Unit *2 |  | Necessary for terminating the Slice I/O Terminal. | GRT1-PC8 | CE, UC1, L, N | |
| | | | GRT1-PC8-1 | | |
| Option | Terminal Block | --- | Package of 5 Terminal Blocks | GRT1-BT1-5 | --- |

*1 Use the Turnback Cable together with the Turnback Units.



*2 The End Unit is sold separately. It is not provided with the Communications Unit.

■ Sensor Communications Unit

| Name | Appearance | I/O classification | Allocated bits | Internal circuit power supply | I/O Power supply voltage | Connected Controller model | Model | Standards |
|----------------------------|---|--------------------------|----------------|--|--------------------------|--|---------|-----------|
| Sensor Communications Unit |  | Change by operation mode | | Supplied along with communications power | DC24V | E3X-HD0 E3X-MDA0 * E3X-DA0-S * E3C-LDA0 * E2C-EDA0 | E3X-CRT | CE |

* Product no longer available to order.

■ Inverter

| Name | Appearance | Mountable Inverter | Model | Standards |
|---------------------------------------|---|--|-----------------|-----------|
| For MX2 CompoNet Communication Unit |  | Multi-function Compact Inverter MX2-Series | 3G3AX-MX2-CRT-E | U, CE |
| For RX-V1 CompoNet Communication Unit |  | High-function General-purpose Inverter RX-Series V1 type * | 3G3AX-RX-CRT-E | |

* Inverters RX-Series V1 type in this catalog have been discontinued.

■ Software

● How to Select Required Support Software for Your Controller

The required Support Software depends on the Controller to connect. Please check the following table when purchasing the Support Software.

| Item | Omron PLC System | Omron Machine Automation Controller System |
|------------|-----------------------------------|--|
| Controller | CS, CJ, CP, and other series | NJ-series |
| Software | FA Integrated Tool Package CX-One | Automation Software Sysmac Studio |

● FA Integrated Tool Package CX-One

| Product name | Specifications | Media | | Model | Standards |
|---|--|--------------------|-------|----------------|-----------|
| | | Number of licenses | Media | | |
| FA Integrated Tool Package CX-One Ver.4.□ | The CX-One is a comprehensive software package that integrates Support Software for OMRON PLCs and components. CX-One Version 4.□ includes CX-Integrator Ver.2.□. | 1 license *1 | DVD | CXONE-AL01D-V4 | --- |

Note: For details, refer to the CX-One Catalog (Cat. No. R134), visit your local OMRON website.

*1. Multi licenses (3, 10, 30, or 50 licenses) and DVD media without licenses are also available for the CX-One.

● Automation Software Sysmac Studio

Please purchase a DVD and required number of licenses the first time you purchase the Sysmac Studio. DVDs and licenses are available individually. Each model of licenses does not include any DVD.

| Product name | Specifications | Media | | Model | Standards |
|---|--|--------------------|----------------------------|------------------|-----------|
| | | Number of licenses | Media | | |
| Sysmac Studio Standard Edition Ver.1.□□ | The Sysmac Studio is the software that provides an integrated environment for setting, programming, debugging and maintenance of machine automation controllers including the NJ/NX-series CPU Units, NY-series Industrial PC, EtherCAT Slave, and the HMI. The Sysmac Studio Standard Edition DVD includes Support Software to set up EtherNet/IP Units, DeviceNet slaves, Serial Communications Units, and Support Software for creating screens on HMIs (CX-Designer). | --- | Sysmac Studio (32-bit) DVD | SYSMAC-SE200D | --- |
| | | --- | Sysmac Studio (64-bit) DVD | SYSMAC-SE200D-64 | --- |
| | | 1 license *1 | --- | SYSMAC-SE201L | --- |

Note: For details, refer to the Sysmac Studio Ver.1.□□ datasheet, visit your local OMRON website.

*1. Multi licenses are available for the Sysmac Studio (3, 10, 30, or 50 licenses).







Peripheral Devices

■ Communications Cables

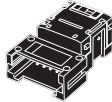
| Name | Appearance | Specification | Model | Standards |
|--------------|---|--|-----------|-----------|
| Flat Cable I |  | 4-conductor flat cable (UL2555) Length: 100 m Conductor diameters: 0.75 mm ² × 2, 0.5 mm ² × 2 | DCA4-4F10 | --- |

Note. Also can be used with general-purpose round cable I (VCTF 2-conductor cable).



● For Flat Cable I

| Name | Appearance | Specification | Model | Standards |
|--------------------------|---|---|------------|-----------|
| Flat Connector Socket |  | Use this Connector in a set with a DCN4-BR4 Flat Connector Plug for the following applications. <ul style="list-style-type: none"> • Extending the trunk line or a sub-trunk line • T-branching from the trunk line or a sub-trunk line • T-branching a sub-branch line from a branch line | DCN4-TR4 * | --- |
| | | Use this Connector independently for the following applications. <ul style="list-style-type: none"> • Used when connecting a DCN4-TM4 Terminating Resistor to the end of the trunk line or a sub-trunk line. | | |
| Flat Connector Plug |  | Use this Connector in a set with a DCN4-TR4 Flat Connector Socket for the following applications. <ul style="list-style-type: none"> • Extending the trunk line or a sub-trunk line • T-branching from the trunk line or a sub-trunk line • T-branching a sub-branch line from a branch line | DCN4-BR4 * | |
| | | Use this Connector independently for the following applications. <ul style="list-style-type: none"> • Connecting Communications Cable to a Unit • Connecting Communications Cable to a DCN4-MD4 Multidrop Connector (when a multidrop connection is used) | | |
| Multidrop Connector |  | Use Multidrop Connectors for multi-drop wiring of Slave Units or Repeater Units to trunk lines, sub-trunk lines, or branch lines. | DCN4-MD4 * | |
| Multidrop Connector Plug |  | Connecting Communications Cable to a Unit in a multidrop connection This connector can be used with the following Units:Bit Slave Units with Compact Connectors (CRT1B-□D0□JS(-1)) | DCN4-MR4 | |
| Terminating Resistance |  | This is a Connector-type Terminating Resistor for Flat Cable I or Round Cable II. It is connected to a DCN4-TR4 Flat Connector Socket at the end of a trunk line or sub-trunk line. | DCN4-TM4 * | |
| Special Tools |  | This is the crimping tool for the following connectors: <ul style="list-style-type: none"> • DCN4-TR4(-1) Flat Connector Socket • DCN4-BR4 Flat Connector Plug • DCN4-BR4D Conversion Connector for Standard Thin Cable and Flat Cable | DWT-A01 | |

Note. Multidrop Connectors (DCN4-MD4) are not connectable with Bit Slave Units with Compact Connectors, Use Multidrop Connector Plugs (DCN4-MR4) instead.

* The minimum quantity packaged is 10 Connectors. Order the Connectors in multiples of 10.





● For Round Cable I

| Name | Appearance | Application | Model | Standards |
|--|---|---|------------|-----------|
| Open Type Connector (for connecting Units) |  | Converts the Unit's communications connector into a screw terminal block to enable connecting round cable to a Slave Unit or Repeater Unit. | DCN4-TB4 * | --- |
| Terminating Resistor |  | This is a Terminal Block-type Terminating Resistor for Round cable I or Round cable II. It is connected to the end of a trunk line or sub-trunk line round cable. | DRS1-T | U |

Note: The DCN4-TB4 Multidrop Connector cannot be used with Bit Slaves with Compact Connectors. Use Open Type Connector (for Unit connection) HCN-TB4LMZG+ from Honda Tsushin Kogyo Co., Ltd. Tel:+81-52-242-2111

* The minimum quantity packaged is 10 Connectors. Order the Connectors in multiples of 10.

● For Round Cable II

| Name | Appearance | Application | Model | Standards |
|--|---|---|------------|-----------|
| Open Type Connector (for connecting Units) |  | Converts the Unit's communications connector into a screw terminal block to enable connecting round cable to a Slave Unit or Repeater Unit. | DCN4-TB4 * | --- |
| Flat Connector Socket |  | Use this Connector in a set with a DCN4-BR4 Flat Connector Plug for the following applications. <ul style="list-style-type: none"> • Extending the trunk line or a sub-trunk line • T-branching from the trunk line or a sub-trunk line • T-branching a sub-branch line from a branch line | DCN4-TR4 * | |
| | | Use this Connector independently for the following applications. <ul style="list-style-type: none"> • Used when connecting a DCN4-TM4 Terminating Resistor to the end of the trunk line or a sub-trunk line. | | |
| Terminating Resistance |  | This is a Connector-type Terminating Resistor for Flat Cable I or Round cable II. It is connected to a DCN4-TR4 Flat Connector Socket at the end of a trunk line or sub-trunk line. | DCN4-TM4 * | |
| |  | This is a Terminal Block-type Terminating Resistor for Round cable I or Round cable II. It is connected to the end of a trunk line or sub-trunk line round cable. | DRS1-T | |
| Special Tools |  | This is the crimping tool for the following connectors: <ul style="list-style-type: none"> • DCN4-TR4(-1) Flat Connector Socket • DCN4-BR4 Flat Connector Plug • DCN4-BR4D Conversion Connector for Standard Thin Cable and Flat Cable | DWT-A01 | |

Note. The DCN4-TB4 Multidrop Connector cannot be used with Bit Slaves with Compact Connectors. Use Open Type Connector (for Unit connection) HCN-TB4LMZG+ from Honda Tsushin Kogyo Co., Ltd. Tel:+81-52-242-2111

* The minimum quantity packaged is 10 Connectors. Order the Connectors in multiples of 10.

■ Mounting Bracket

| Name | Appearance | Application | Model | Standards |
|------------------|------------|--|------------|-----------|
| Mounting Bracket | --- | Unit with e-CON Connectors: For CRT1-V□D08S(-1)/VAD04S/VDA02S | CRT1-ATT02 | --- |
| | | Unit with MIL Connectors: For CRT1-V□D016ML(-1)/VAD04ML/VDA02ML | CRT1-ATT01 | |
| | | Unit with MIL Connectors: For CRT1-V□D32ML(-1) | SRT2-ATT02 | |
| | | Bit Slaves with Compact Connectors: For CRT1B-□D02JS(-1), CRT1B-□D04JS(-1) | CRT1-ATT03 | |

Related Manuals

Manuals

| Cat. No. | Model | Name |
|-------------|--|--|
| W457 | CRT1 Series | CRT2 Series CompoNet Slave Units and Repeater Unit Operation Manual |
| W493 | CJ1W-CRM21 | CJ1W-CRM22 CJ-series CompoNet Master Units Operation Manual for NJ-series CPU Unit |
| W456 | CS1W-CRM21/CJ1W-CRM21 | CompoNet Master Units OPERATION MANUAL |
| W485 | 3G8F7-CRM21(for PCI Bus)/3G8F8-CRM21(for CompactPCI Bus) | CompoNet Master Board USER'S MANUAL |
| W489 | GQ-CRM21 | CC-Link-CompoNet GateWay Unit USER'S MANUAL |
| W342 | SYSMAC CS/CJ/CP Series, SYSMAC One NSJ Series | SYSMAC CS/CJ/CP/NSJ Series Communications Commands REFERENCE MANUAL |
| W504 | SYSMAC-SE2□□□ | SYSMAC-SE2□□□ Sysmac Studio Version 1 OPERATION MANUAL |
| W464 | CXONE-AL□□D-V4 | CS/CJ/CP/NSJ Series CX-Integrator Ver.2.□ OPERATION MANUAL |
| W455 | SmartSlice GRT1 Series | Slice I/O Units OPERATION MANUAL |
| W476 | GRT1-CRT | SmartSlice CompoNet Communications Units OPERATION MANUAL |
| I582 | 3G3AX-MX2-CRT-E/3G3AX-RX-CRT-E | MX2-Series V1type/RX-Series V1 type CompoNet Communication Unit User's Manual |

Terms and Conditions Agreement

Read and understand this catalog.

Please read and understand this catalog before purchasing the products. Please consult your OMRON representative if you have any questions or comments.

Warranties.

- (a) Exclusive Warranty. Omron's exclusive warranty is that the Products will be free from defects in materials and workmanship for a period of twelve months from the date of sale by Omron (or such other period expressed in writing by Omron). Omron disclaims all other warranties, express or implied.
- (b) Limitations. OMRON MAKES NO WARRANTY OR REPRESENTATION, EXPRESS OR IMPLIED, ABOUT NON-INFRINGEMENT, MERCHANTABILITY OR FITNESS FOR A PARTICULAR PURPOSE OF THE PRODUCTS. BUYER ACKNOWLEDGES THAT IT ALONE HAS DETERMINED THAT THE PRODUCTS WILL SUITABLY MEET THE REQUIREMENTS OF THEIR INTENDED USE.

Omron further disclaims all warranties and responsibility of any type for claims or expenses based on infringement by the Products or otherwise of any intellectual property right. (c) Buyer Remedy. Omron's sole obligation hereunder shall be, at Omron's election, to (i) replace (in the form originally shipped with Buyer responsible for labor charges for removal or replacement thereof) the non-complying Product, (ii) repair the non-complying Product, or (iii) repay or credit Buyer an amount equal to the purchase price of the non-complying Product; provided that in no event shall Omron be responsible for warranty, repair, indemnity or any other claims or expenses regarding the Products unless Omron's analysis confirms that the Products were properly handled, stored, installed and maintained and not subject to contamination, abuse, misuse or inappropriate modification. Return of any Products by Buyer must be approved in writing by Omron before shipment. Omron Companies shall not be liable for the suitability or unsuitability or the results from the use of Products in combination with any electrical or electronic components, circuits, system assemblies or any other materials or substances or environments. Any advice, recommendations or information given orally or in writing, are not to be construed as an amendment or addition to the above warranty.

See <http://www.omron.com/global/> or contact your Omron representative for published information.

Limitation on Liability: Etc.

OMRON COMPANIES SHALL NOT BE LIABLE FOR SPECIAL, INDIRECT, INCIDENTAL, OR CONSEQUENTIAL DAMAGES, LOSS OF PROFITS OR PRODUCTION OR COMMERCIAL LOSS IN ANY WAY CONNECTED WITH THE PRODUCTS, WHETHER SUCH CLAIM IS BASED IN CONTRACT, WARRANTY, NEGLIGENCE OR STRICT LIABILITY.

Further, in no event shall liability of Omron Companies exceed the individual price of the Product on which liability is asserted.

Suitability of Use.

Omron Companies shall not be responsible for conformity with any standards, codes or regulations which apply to the combination of the Product in the Buyer's application or use of the Product. At Buyer's request, Omron will provide applicable third party certification documents identifying ratings and limitations of use which apply to the Product. This information by itself is not sufficient for a complete determination of the suitability of the Product in combination with the end product, machine, system, or other application or use. Buyer shall be solely responsible for determining appropriateness of the particular Product with respect to Buyer's application, product or system. Buyer shall take application responsibility in all cases.

NEVER USE THE PRODUCT FOR AN APPLICATION INVOLVING SERIOUS RISK TO LIFE OR PROPERTY OR IN LARGE QUANTITIES WITHOUT ENSURING THAT THE SYSTEM AS A WHOLE HAS BEEN DESIGNED TO ADDRESS THE RISKS, AND THAT THE OMRON PRODUCT(S) IS PROPERLY RATED AND INSTALLED FOR THE INTENDED USE WITHIN THE OVERALL EQUIPMENT OR SYSTEM.

Programmable Products.

Omron Companies shall not be responsible for the user's programming of a programmable Product, or any consequence thereof.

Performance Data.

Data presented in Omron Company websites, catalogs and other materials is provided as a guide for the user in determining suitability and does not constitute a warranty. It may represent the result of Omron's test conditions, and the user must correlate it to actual application requirements. Actual performance is subject to the Omron's Warranty and Limitations of Liability.

Change in Specifications.

Product specifications and accessories may be changed at any time based on improvements and other reasons. It is our practice to change part numbers when published ratings or features are changed, or when significant construction changes are made. However, some specifications of the Product may be changed without any notice. When in doubt, special part numbers may be assigned to fix or establish key specifications for your application. Please consult with your Omron's representative at any time to confirm actual specifications of purchased Product.

Errors and Omissions.

Information presented by Omron Companies has been checked and is believed to be accurate; however, no responsibility is assumed for clerical, typographical or proofreading errors or omissions.

This catalog mainly provides information that is necessary for selecting suitable models, and does not contain precautions for correct use. Always read the precautions and other required information provided in product operation manuals before using the product.

- The application examples provided in this catalog are for reference only. Check functions and safety of the equipment before use.
- Never use the products for any application requiring special safety requirements, such as nuclear energy control systems, railroad systems, aviation systems, medical equipment, amusement machines, vehicles, safety equipment, or other application involving serious risk to life or property, without ensuring that the system as a whole has been designed to address the risks, and that the OMRON products are properly rated and installed for the intended use within the overall equipment or system.

Note: Do not use this document to operate the Unit.

OMRON Corporation Industrial Automation Company

Kyoto, JAPAN

Contact : www.ia.omron.com

Regional Headquarters

OMRON EUROPE B.V.

Wegalaan 67-69, 2132 JD Hoofddorp
The Netherlands

Tel: (31) 2356-81-300 Fax: (31) 2356-81-388

OMRON ASIA PACIFIC PTE. LTD.

438B Alexandra Road, #08-01/02 Alexandra
Technopark, Singapore 119968

Tel: (65) 6835-3011 Fax: (65) 6835-3011

OMRON ELECTRONICS LLC

2895 Greenspoint Parkway, Suite 200
Hoffman Estates, IL 60169 U.S.A.

Tel: (1) 847-843-7900 Fax: (1) 847-843-7787

OMRON (CHINA) CO., LTD.

Room 2211, Bank of China Tower,
200 Yin Cheng Zhong Road,
PuDong New Area, Shanghai, 200120, China

Tel: (86) 21-6023-0333 Fax: (86) 21-5037-2388

Authorized Distributor:

©OMRON Corporation 2015-2023 All Rights Reserved.
In the interest of product improvement,
specifications are subject to change without notice.

CSM_17_18

Cat. No. P056-E1-18 0923 (1006)