

# PM3200 series

## User manual

DOCA0006EN-07  
03/2022



# Legal Information

The Schneider Electric brand and any trademarks of Schneider Electric SE and its subsidiaries referred to in this guide are the property of Schneider Electric SE or its subsidiaries. All other brands may be trademarks of their respective owners.

This guide and its content are protected under applicable copyright laws and furnished for informational use only. No part of this guide may be reproduced or transmitted in any form or by any means (electronic, mechanical, photocopying, recording, or otherwise), for any purpose, without the prior written permission of Schneider Electric.

Schneider Electric does not grant any right or license for commercial use of the guide or its content, except for a non-exclusive and personal license to consult it on an "as is" basis. Schneider Electric products and equipment should be installed, operated, serviced, and maintained only by qualified personnel.

As standards, specifications, and designs change from time to time, information contained in this guide may be subject to change without notice.

To the extent permitted by applicable law, no responsibility or liability is assumed by Schneider Electric and its subsidiaries for any errors or omissions in the informational content of this material or consequences arising out of or resulting from the use of the information contained herein.

# Safety information

## Important information

Read these instructions carefully and look at the equipment to become familiar with the device before trying to install, operate, service, or maintain it. The following special messages may appear throughout this manual or on the equipment to warn of potential hazards or to call attention to information that clarifies or simplifies a procedure.



The addition of either symbol to a “Danger” or “Warning” safety label indicates that an electrical hazard exists which will result in personal injury if the instructions are not followed.



This is the safety alert symbol. It is used to alert you to potential personal injury hazards. Obey all safety messages that accompany this symbol to avoid possible injury or death.

### **DANGER**

**DANGER** indicates a hazardous situation which, if not avoided, **will result in** death or serious injury.

**Failure to follow these instructions will result in death or serious injury.**

### **WARNING**

**WARNING** indicates a hazardous situation which, if not avoided, **could result in** death or serious injury.

### **CAUTION**

**CAUTION** indicates a hazardous situation which, if not avoided, **could result in** minor or moderate injury.

### **NOTICE**

NOTICE is used to address practices not related to physical injury.

## Please note

Electrical equipment should be installed, operated, serviced and maintained only by qualified personnel. No responsibility is assumed by Schneider Electric for any consequences arising out of the use of this material. A qualified person is one who has skills and knowledge related to the construction, installation, and operation of electrical equipment and has received safety training to recognize and avoid the hazards involved.

# Notices

## FCC

This equipment has been tested and found to comply with the limits for a Class B digital device, pursuant to part 15 of the FCC rules. These limits are designed to provide reasonable protection against harmful interference in a residential installation. This equipment generates, uses, and can radiate radio frequency energy and, if not installed and used in accordance with the instructions, may cause harmful interference to radio communications. However, there is no guarantee that the interference will not occur in a particular installation. If this equipment does cause harmful interference to radio or television reception, which can be determined by turning the equipment off and on, the user is encouraged to try to correct the interference by one or more of the following measures:

- Reorient or relocate the receiving antenna.
- Increase the separation between the equipment and receiver.
- Connect the equipment to an outlet on a circuit different from that to which the receiver is connected.
- Consult the dealer or an experienced radio/TV technician for help.

The user is cautioned that any changes or modifications not expressly approved by Schneider Electric could void the user's authority to operate the equipment.

This digital apparatus complies with CAN ICES-3 (B) /NMB-3(B).

# About this manual

## Document scope

This manual is intended for use by designers, system builders and maintenance technicians with an understanding of electrical distribution systems and monitoring devices.

Throughout the manual, the term “meter” / device” / “equipment” / “product” refers to all models of the PM3200 series. All differences between the models, such as a feature specific to one model, are indicated with the appropriate model number or description.

This manual does not provide configuration information for advanced features where an expert user would perform advanced configuration. It also does not include instructions on how to incorporate meter data or perform meter configuration using energy management systems or software, other than ION Setup.

## Validity note

The PM3200 series meters are used to measure electrical parameters of an installation or a part of an installation.

This function meets the requirements for:

- Installation monitoring
- Alarming on consumption drifts
- Consumption monitoring
- Evaluation of energy items (cost, accounting, etc)
- Logging of historical consumption
- Identifying harmonic disturbances

This function may also satisfy the power-saving incentives implemented by many countries.

## Related documents

Document	Number
PM3200 / PM3210 instruction sheet	S1B46605 / S1B62913
PM3250 / PM3255 instruction sheet	S1B46607 / S1B62914

You can download these technical publications and other technical information from [www.se.com](http://www.se.com).



# Table of Contents

Safety precautions .....	11
Meter overview .....	12
Overview of meter functions .....	12
Main Characteristics .....	12
Hardware reference and installation .....	14
Supplemental information.....	14
Meter sealing points.....	14
Meter description.....	14
Dismounting the meter from a DIN rail.....	15
Input, output and communications wiring considerations.....	16
Functions.....	17
Meter characteristics.....	17
Real-time measuring.....	17
Minimum/Maximum values .....	17
Demand readings .....	18
Energy readings .....	19
Power quality analysis values .....	20
Quick response code .....	20
Other Characteristics .....	21
Alarms.....	21
Overview.....	21
Alarms configuration .....	22
Viewing alarm status on the display.....	23
Alarm activity and history.....	23
Using an alarm to control a digital output.....	23
Input/output capabilities .....	23
Digital inputs (PM3255).....	23
Pulse output (PM3210).....	24
Digital outputs (PM3255).....	24
Multi-tariff.....	24
DI control mode (PM3255).....	25
Communication control mode (PM3250 / PM3255).....	25
Real-time clock (RTC) control mode .....	25
Data logging (PM3255) .....	26
Energy log.....	26
Flex log.....	27
Meter operation .....	29
Overview .....	29
Display screen overview.....	29
Status information.....	29
Backlight and diagnosis / alarm icon.....	29
Configuration mode .....	30
Overview.....	30
Default configuration mode settings.....	30
Entering configuration mode .....	31
Modifying parameters.....	31
Clock setting.....	32

Configuration mode menu trees .....	33
Display mode .....	37
Entering the display mode .....	37
Display mode menu tree for PM3200 .....	37
Display mode menu tree for PM3210 / PM3250 / PM3255 .....	38
Full screen mode .....	38
Overview .....	38
Entering the full screen mode .....	39
Full screen mode menu tree for PM3200 .....	40
Full screen mode menu tree for PM3210 / PM3250 / PM3255 .....	41
Communication via Modbus (PM3250 / PM3255) .....	42
Overview .....	42
Modbus communications settings .....	42
Communications LED indicator for Modbus devices .....	42
Modbus functions .....	42
Function list .....	42
Table format .....	43
Command interface .....	44
Command interface overview .....	44
Command request .....	44
Command list .....	45
Modbus register list .....	50
System .....	50
Meter Setup and Status .....	51
Energy Pulse Output Setup .....	51
Command Interface .....	51
Communications .....	52
Input Metering Setup .....	52
Digital Inputs .....	53
Digital Outputs .....	53
Basic Meter Data .....	53
Demand .....	57
MinMax Reset .....	58
Minimum Values .....	58
Maximum Values .....	59
MinMax with Time Stamp .....	61
Power Quality .....	61
Alarms .....	62
Energy Log .....	66
Flex log record information .....	68
Flex log configuration information .....	68
Read Device Identification .....	68
Power, energy and power factor .....	70
Power (PQS) .....	70
Power and the PQ coordinate system .....	70
Power flow .....	70
Energy delivered (imported) / energy received (exported) .....	70
Power factor (PF) .....	71
PF lead / lag convention .....	71
PF sign convention .....	72
Power factor register format .....	73



---

Maintenance and Troubleshooting .....	75
Overview .....	75
Password recovery .....	75
Language Download .....	75
Enabling language download on the meter .....	75
Diagnostic codes .....	75
Specifications .....	77
China Standard Compliance .....	81



# Safety precautions

Installation, wiring, testing and service must be performed in accordance with all local and national electrical codes.

## **⚠️⚠️ DANGER**

### **HAZARD OF ELECTRIC SHOCK, EXPLOSION, OR ARC FLASH**

- Apply appropriate Personal Protective Equipment (PPE) and follow safe electrical work practices. See NFPA 70E, CSA Z462 or other local standards.
- This equipment must only be installed and serviced by qualified electrical personnel.
- Turn off all power supplying this device and the equipment in which it is installed before working on or in the equipment.
- Always use a properly rated voltage sensing device to confirm that all power is off.
- Assume communications and I/O wiring are hazardous live until determined otherwise.
- Before performing visual inspections, tests, or maintenance on this equipment, disconnect all sources of electric power. Assume that all circuits are live until they have been completely de-energized, tested and tagged. Pay particular attention to the design of the power system. Consider all power supply sources, particularly the potential for backfeed.
- Do not exceed the maximum ratings of this device.
- Replace all devices, doors and covers before turning on power to this equipment.
- Never short the secondary of a Voltage Transformer (VT).
- Never open circuit a Current Transformer (CT).
- Always use grounded external CTs for current inputs.
- Do not use water or any liquid material to clean the product. Use a cleaning cloth to remove dirt. If dirt cannot be removed, contact local Technical Support representative.

**Failure to follow these instructions will result in death or serious injury.**

## **⚠️ WARNING**

### **UNINTENDED OPERATION**

Do not use the meter for critical control or protection applications where human or equipment safety relies on the operation of the control circuit.

**Failure to follow these instructions can result in death, serious injury, or equipment damage.**

## **⚠️ WARNING**

### **INACCURATE DATA RESULTS**

- Do not rely solely on data displayed on the display or in software to determine if this device is functioning correctly or complying with all applicable standards.
- Do not use data displayed on the display or in software as a substitute for proper workplace practices or equipment maintenance.

**Failure to follow these instructions can result in death, serious injury, or equipment damage.**

# Meter overview

## Overview of meter functions

The PM3200 series meters provide accurate 3-phase electrical parameters monitoring.

Following are the meter models:

- PM3200
- PM3210
- PM3250
- PM3255

The meters provide the various measurement capabilities required to monitor an electrical installation such as current, voltage, power, power factor, frequency, and energy.

The key features of the meters are:

- Electrical parameters monitoring such as I, In, U, V, PQS, E, PF, Hz
- Power / current demand, peak demand
- Time-stamped alarms
- Minimum/maximum values for many parameters
- Management of up to 4 tariffs
- Up to 2 digital inputs and 2 digital outputs
- Modbus communication
- QR codes with embedded data for viewing meter information using Meter Insights

## Main Characteristics

Function	PM3200	PM3210	PM3250	PM3255
Measurement inputs through CTs (1 A, 5 A)	√	√	√	√
Measurement inputs through VTs	√	√	√	√
Four quadrant energy measurements	√	√	√	√
Electrical measurements (I, In, V, PQS, PF, Hz)	√	√	√	√
THD current and voltage	—	√	√	√
Current, power demand, present	√	√	√	√
Current, power demand, peak	—	√	√	√
Minimum / maximum of instantaneous values	√	√	√	√
Power demand logs	—	—	—	√
Energy consumption log (day, week, month)	—	—	—	√
Multi-tariff (internal clock)	4 tariffs	4 tariffs	4 tariffs	4 tariffs
Multi-tariff (external control by DI)	—	—	—	4 tariffs
Multi-tariff (external control by communication)	—	—	4 tariffs	4 tariffs
Measurement display	√	√	√	√
Digital inputs	—	—	—	2 digital inputs
Digital outputs	—	—	—	2 digital outputs

Function	PM3200	PM3210	PM3250	PM3255
Pulse output	—	√	—	—
Alarms with time stamping	—	√	√	√
QR Code	√	√	√	√
Modbus communication	—	—	√	√

# Hardware reference and installation

## Supplemental information

This document is intended to be used in conjunction with the instruction sheet that ships in the box with the meter.

See the meter's instruction sheet for information related to installation.

You can download updated documentation from [www.se.com](http://www.se.com) or contact your local Schneider Electric representative for the latest information about your product.

## Meter sealing points

All meters have sealing covers and three sealing points to help prevent access to inputs, outputs, current, and voltage connections.

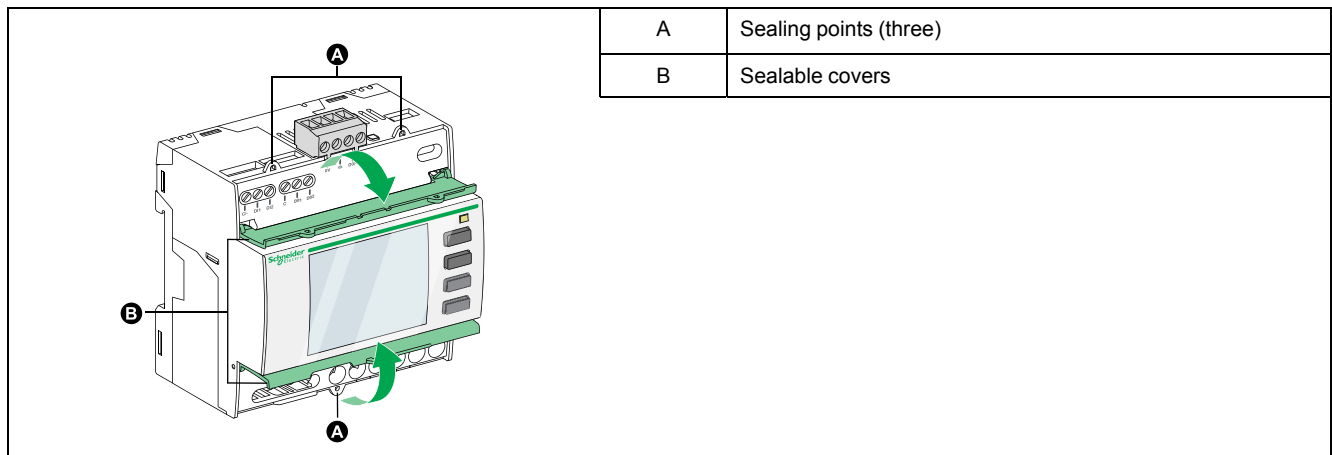

## Meter description

### PM3200 / PM3210

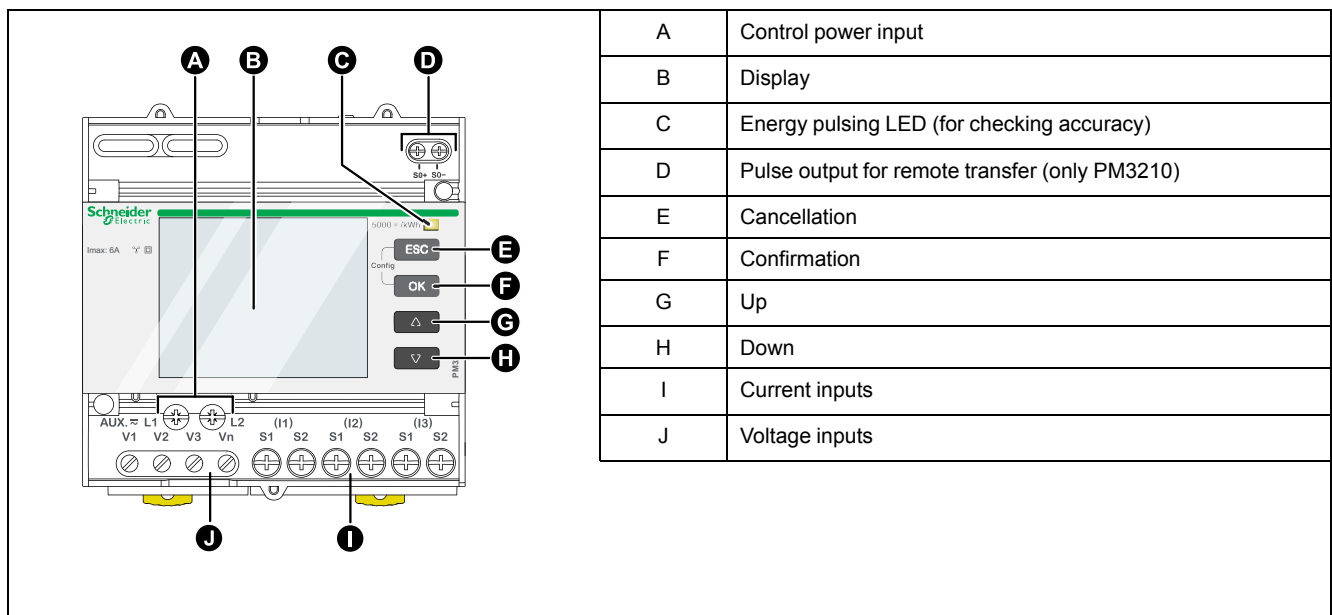

## PM3250 / PM3255

A	Digital inputs x 2 (only PM3255)
B	Digital outputs x 2 (only PM3255)
C	Communication port
D	Communications LED (for communication diagnosis)
E	Energy pulsing LED (for checking accuracy)
F	Cancellation
G	Confirmation
H	Up
I	Down
J	Display
K	Current inputs
L	Control power input
M	Voltage inputs

## Dismounting the meter from a DIN rail

1. Use a flat-tip screwdriver ( $\leq 6.5$  mm / 0.25 in) to lower the locking mechanism and release the meter.

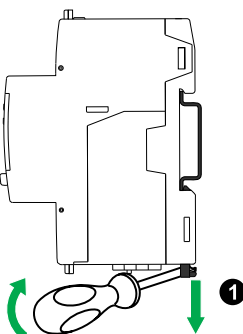

2. Lift the meter out and up to free it from the DIN rail.

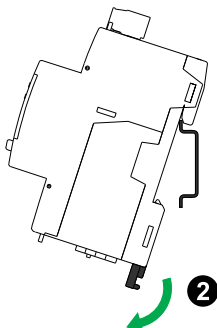

## Input, output and communications wiring considerations

### **⚠ WARNING**

#### **UNINTENDED OPERATION**

Be aware that an unexpected change of state of the digital outputs may result when the supply power to the meter is interrupted.

**Failure to follow these instructions can result in death, serious injury, or equipment damage.**

The digital outputs of PM3255 are polarity independent.

The digital inputs and outputs of PM3255 are electrically independent.



# Functions

## Meter characteristics

The meter measures currents and voltages and reports real-time RMS values for all 3-phases and neutral. In addition, the meter calculates power factor, real power, reactive power, and more.

## Real-time measuring

The following table lists the metering characteristics of the meter for the real-time measurement:

Characteristics	Description
Current	Per phase, neutral, and average of 3 phases
Voltage	L-L, L-N, and average of 3 phases
Frequency	40...70 Hz
Active power	Total and per phase (signed)
Reactive power	Total and per phase (signed)
Apparent power	Total and per phase
Power factor (True)	Total and per phase 0.000 to 1 (signed) by display 0.000 to 2 (signed) by communications
Tangent phi (Reactive factor)	Total
Current unbalance	Per phase, most unbalanced of 3 phases
Voltage unbalance	L-L, most unbalanced of 3 phases L-N, most unbalanced of 3 phases

## Minimum/Maximum values

When any one-second real-time reading reaches its highest or lowest value, the meter saves the minimum and maximum values in its nonvolatile memory.

From the meter display, you can:

- View all minimum/maximum values since the last reset and the reset date and time
- Reset minimum/maximum values

All running minimum/maximum values are arithmetic minimum and maximum values. For example, the minimum phase A-N voltage is the lowest value in the range from 0 to 1 MV that has occurred since last reset of the minimum/maximum values.

The meter provides time stamping for 6 minimum/maximum values.

The following table lists the minimum and maximum values stored in the meter:

Characteristics	Description
Current	Per phase, neutral, and average <sup>1</sup> Minimum: lowest of 3 phases <sup>2</sup> Maximum: highest of 3 phases <sup>2</sup>
Voltage	L-L and L-N per phase and average
Frequency	–
Active power	Per phase <sup>1</sup> and total
Reactive power	Per phase <sup>1</sup> and total
Apparent power	Per phase <sup>1</sup> and total
Power factor	Per phase <sup>1</sup> and total
Tangent phi (Reactive factor)	Total <sup>1</sup>
THD current (PM3210 / PM3250 / PM3255)	Maximum: Per phase, neutral, and highest of 3 phase <sup>2</sup> Minimum: Per phase <sup>1</sup> and neutral <sup>1</sup>
THD voltage (PM3210 / PM3250 / PM3255)	L-L and L-N per phase <sup>1</sup> Maximum: Highest of 3 phases <sup>2</sup> Minimum: Lowest of 3 phases <sup>2</sup>

## Demand readings

The meter provides the following demand readings.

Characteristics	Description
Current	Per phase, neutral, and average <sup>1</sup>
Active power, reactive power, apparent power	Total
Peak demand values (PM3210 / PM3250 / PM3255)	
Current	Per phase, neutral, and average <sup>1</sup>
Active power, reactive power, apparent power	Total

## Demand calculation methods

Power demand is the energy accumulated during a specified period divided by the length of the period. Current demand is calculated using arithmetical integration of the current RMS values during a time period, divided by the length of the period. How the meter performs this calculation depends on the selected method. To be compatible with electric utility billing practices, the meter provides the block interval power/current demand calculations.

For block interval demand calculations, you select a block of time (interval) that the meter uses for the demand calculation and the mode the meter uses to handle the interval. 2 different modes are possible:

- **Fixed block** - Select an interval from 1 to 60 minutes (in 1 minute increments). The meter calculates and updates the demand at the end of each interval.

1. Available only through communications  
2. Available only on the display

- Sliding block** - Select an interval from the range 10, 15, 20, 30, 60 minutes. For demand intervals less than 15 minutes, the value is updated every 15 seconds. For demand intervals of 15 minutes and greater, the demand value is updated every 60 seconds. The meter displays the demand value for the last completed interval.

The following figures illustrate the 2 ways to calculate demand power using the block method. For illustration purposes, the interval is set to 15 minutes.

**Fixed Block**

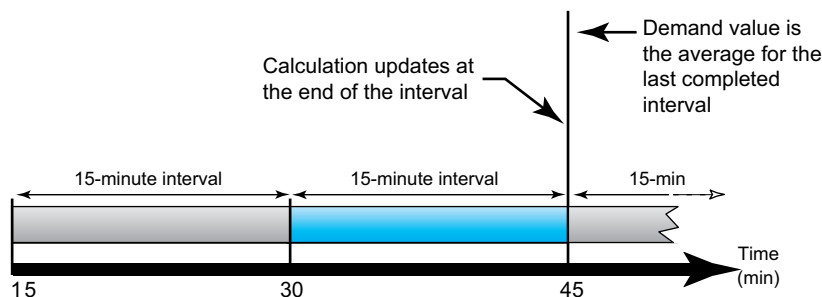

**Sliding Block**

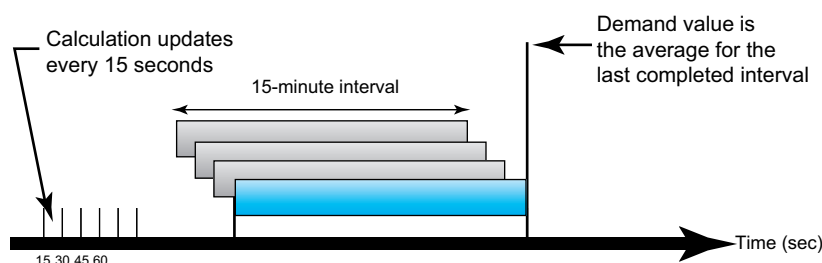

**Peak demand**

In nonvolatile memory, the meter maintains a maximum operating demand values called peak demand. The peak is the highest value (absolute value) for each of these readings since the last reset.

You can reset peak demand values from the meter display. You should reset peak demand after changes to basic meter setup such as CT ratio or power system configuration.

**Energy readings**

The meter calculates and stores total and partial energy values for active energy, reactive energy, and apparent energy.

You can view energy values from the display. The resolution of the energy value automatically changes from kWh to MWh (kVAh to MVARh).

The energy values automatically resets to 0 when it reaches the limit of  $1 \times 10^6$  MWh,  $1 \times 10^6$  MVAh, or  $1 \times 10^6$  MVARh. Manual reset of total energy is not allowed. You can reset the partial energy values including partial energy import, energy by tariff, and phase energy manually using the display.

Energy values can be reported over communications as 64-bit signed integers. The units are always Wh, VARh, or VAh.

The following table lists the energy readings from the meter:

Characteristics	Description
<b>Energy values (import)</b>	
Active energy	Total and per phase, partial, by tariff 0 to 1 x 10 <sup>12</sup> Wh Auto reset to 0 in case of over limit
Reactive energy	Total and per phase, partial 0 to 1 x 10 <sup>12</sup> VARh Auto reset to 0 in case of over limit
Apparent energy	Total and per phase, partial 0 to 1 x 10 <sup>12</sup> VAh Auto reset to 0 in case of over limit
<b>Energy values (export)</b>	
Active energy	Total 0 to 1 x 10 <sup>12</sup> Wh Auto reset to 0 in case of over limit
Reactive energy	Total 0 to 1 x 10 <sup>12</sup> VARh Auto reset to 0 in case of over limit
Apparent energy	Total 0 to 1 x 10 <sup>12</sup> VAh Auto reset to 0 in case of over limit

## Power quality analysis values

The power quality analysis values use the following abbreviations:

- $HC \text{ (Harmonic Content)} = \sqrt{(H_2^2 + H_3^2 + H_4^2 + \dots)}$
- H1 = Fundamental Content
- $THD \text{ (Total Harmonic Distortion)} = HC/H1 \times 100\%$

THD provides a measure of the total distortion present in a waveform. THD is the ratio of harmonic content to the fundamental and provides a general indication of the quality of a waveform. THD is calculated for both voltage and current.

The following table lists the power quality values of the meter:

<b>Power quality values (PM3210 / PM3250 / PM3255)</b>	
Characteristics	Description
THD	Per phase current and per phase voltage (L-L and L-N) Most distorted of 3 phases Average of 3 phases <sup>3</sup>

## Quick response code

A Quick Response Code (QR Code) is a type of matrix barcode used to store data efficiently.

3. Available only through communications

You can view energy values and read data by scanning the QR Code displayed on the meter screen. The dynamically generated QR Code contains a URL that represents the meter's data.

The URL provides basic configuration information about the meter, including power system, and communication configuration. Other parameters such as product reference, serial number, and firmware version are also included as elements in the URL.

## Other Characteristics

The following table lists other characteristics of the meter:

Characteristics	Description
<b>Reset</b>	
Epart	Per phase, partial, by tariff energy values
Minimum and maximum values	—
Peak demand values	—
<b>Local or remote setup</b>	
Distribution system type	Three-phase 3-wire or 4-wire with 1, 2, or 3 CTs Single-phase 2-wire or 3-wire with 1 or 2 CTs, with or without VTs
Current transformers rating	Primary 5 to 32767 A Secondary 5 A, 1 A
Voltage transformers rating	Primary 1000000 Vmax Secondary 100, 110, 115, 120
Current demand calculation method	1 to 60 minutes
Power demand calculation method	1 to 60 minutes

## Alarms

### Overview

The meter provides setpoint-driven alarms. The alarms include:

Alarms	PM3210 / PM3250	PM3255
<b>Standard alarms</b>		
Over Current, Phase	√	√
Under Current, Phase	—	√
Over Voltage, L-L	√	√
Under Voltage, L-L	√	√
Over Voltage, L-N	—	√
Under Voltage, L-N	√	√
Over Power, Total Active	√	√
Over Power, Total Reactive	—	√
Over Power, Total Apparent	√	√
Leading Power Factor, Total	—	√

Alarms	PM3210 / PM3250	PM3255
Lagging Power Factor, Total	–	√
Over Demand, Total Active Power, Present	–	√
Over Demand, Total Apparent Power, Present	–	√
Over THD-U, Phase	–	√
Under Power, Total Active	√	√
Over THD-I, Phase	–	√
Over THD-V, Phase	–	√
<b>Customized Alarms</b>		
Over Energy, Total Active	–	√

## Alarms configuration

For the standard alarms, you must configure the following features by using the display or communication:

- Pickup setpoint
- Trigger delay (Pickup/Dropout delay)
- Dropout setpoint (Deviation percentage from pickup setpoint)

Among the standard alarms, dropout setpoint and trigger delay are common features of all the alarms. Pickup setpoint is identical for each alarm.

For more information on how the meter handles the setpoint-driven alarms, refer to the following figure:

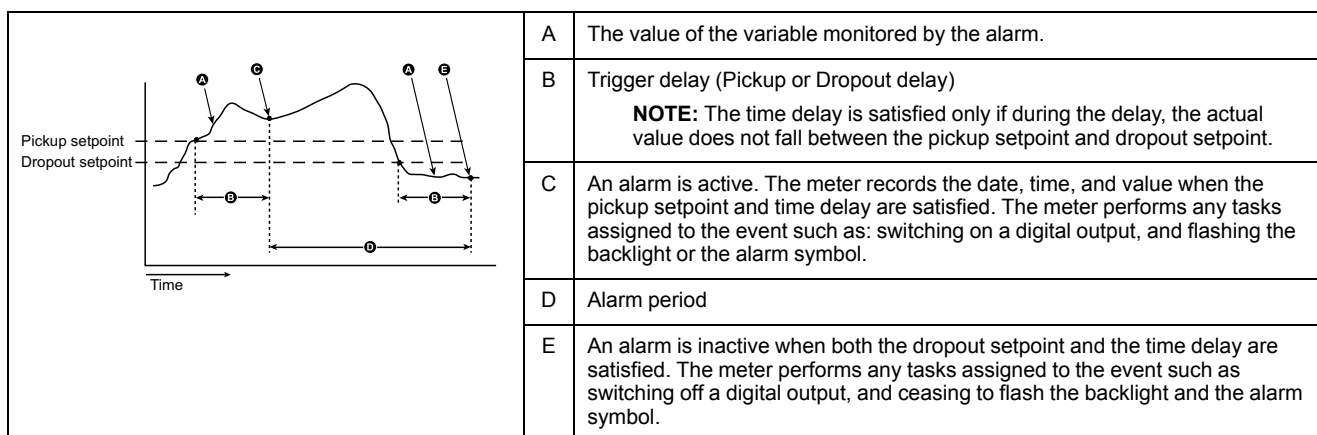

For the Over Energy alarm, you also need to configure the method, which refers to the energy accumulation and detection period.

The 3 options are:

- Day method: the energy accumulation starts at 8:00 A.M. every day and clears up at 8:00 A.M. the next day.
- Week method: the energy accumulation starts at 8:00 A.M. every Sunday and clears up at 8:00 A.M. the next Sunday.
- Month method: the energy accumulation starts at 8:00 A.M. on the first day of the month and clears up at 8:00 A.M. on the first day of the next month.

When the accumulated energy pickup setpoint and time delay are satisfied, the alarm is active. When the accumulated energy dropout setpoint and time delay are satisfied, the alarm is inactive.

## Viewing alarm status on the display

The alarm status summary page includes the following items:

- Tot Enable: displays total number of the alarms enabled by the user in the alarm configuration.
- Tot Active: displays total number of the active alarms. One active alarm with several entries is considered as one. For example, over current at phase 1 creates the first entry, over current at phase 2 creates the second entry, but the total number of the active alarms is one.
- Output: refers to the association with digital output (DO).

The alarm level 2 page lists the number of entries of the active and logged alarms.

The logged alarm entries include the active alarms and the historic alarms. One alarm that has occurred several times can create several active or logged entries.

The alarm level 3 page lists the detailed information of each active/log entry.

**NOTE:** When an active alarm is not present and you enter the log entry list, the meter considers that you have acknowledged all the logged alarms.

## Alarm activity and history

The active alarm list holds 20 entries at a time. The list works as a circular buffer, replacing the oldest entries with the newest entries. The information in the active alarm list is volatile. When the meter resets, this list is reinitialized.

The alarm history log holds 20 entries of alarms that have disappeared. The log also works as a circular buffer. This information is non-volatile.

## Using an alarm to control a digital output

You can associate a digital output with an alarm. Refer to *Input/output capabilities*, page 23 for more information.

## Input/output capabilities

### **▲ WARNING**

#### **UNINTENDED OPERATION**

- Do not use the meter for critical control or protection applications where human or equipment safety relies on the operation of the control circuit.
- Be aware that an unexpected change of state of the digital outputs may result when the supply power to the meter is interrupted.

**Failure to follow these instructions can result in death, serious injury, or equipment damage.**

## Digital inputs (PM3255)

The meter can accept 2 digital inputs DI1 and DI2.

The digital inputs have 4 operating modes:

- Normal input status: Use for simple ON/OFF digital inputs. The digital inputs can be OF or SD signals of a circuit breaker.

- Multi-tariff control: You can control the tariff either through communications, the internal clock or by 1 or 2 tariff inputs. Tariff control through the tariff inputs is performed by applying a proper combination of ON or OFF signal to the inputs. Each combination of ON or OFF signal results in the meter registering the energy in a particular tariff register. Refer to the following table for input coding.
- Input metering: You can configure the meter in input metering modes to collect the pulses for WAGES application. To activate this function, set the input metering pulse frequency (pulse/unit). The meter counts the number of pulses and calculates the number of units. Pulse width or pulse stop less than 10 ms is invalid for pulse counting.
- Energy reset: Energy reset function resets partial energy, energy by tariff, and energy by phase. Reset is activated by an ON signal lasting for over 10 ms.

The following table describes the input coding in binary format:

Input voltage	Active tariff
<b>Meter with 4 tariffs:</b>	
DI1/DI2 = OFF/OFF	Tariff 1 active
DI1/DI2 = OFF/ON	Tariff 2 active
DI1/DI2 = ON/OFF	Tariff 3 active
DI1/DI2 = ON/ON	Tariff 4 active
<b>Meter with 2 tariffs:</b>	
(Always associated with DI1, and DI2 can be left floating or configured as other mode)	
DI1 = OFF	Tariff 1 active
DI1 = ON	Tariff 2 active

## Pulse output (PM3210)

Pulse output is used for active energy pulse output only. You can configure the pulse frequency (pulse/kWh) and the pulse width. The minimum pulse width is 50 ms. The pulse stop is equal or longer than the pulse width. The pulse output indicates the primary energy consumption considering transformer ratios. You should set a proper value of pulse frequency and pulse width to avoid pulse missing due to over-counting.

## Digital outputs (PM3255)

The meter has 2 solid-state relay outputs (DO1 and DO2). The relay outputs have 4 operation modes:

- Alarm: The output is controlled by the meter in response to an alarm condition. The output turns ON (relay closed) when at least one alarm is active. The output turns OFF (relay open) when the alarm is deactivated.
- Energy Output: You can use DO1 only for active energy pulse output and DO2 only for reactive energy pulse output. You can configure the pulse frequency (pulse/kWh or pulse/kVARh) and the pulse width.
- Disable: The digital output function is disabled.
- External: The output is controlled by the meter in response to a command 21000.

## Multi-tariff

The meter provides multi-tariff energy accumulation. It supports up to 4 tariffs.



The tariff switching has the following 3 kinds of control modes:

- Digital input
- Communication
- Internal real-time clock (RTC)

You can configure the control mode by using the display (all the 3 modes) or by using communication (not for RTC).

Command number 2060 is used to configure the control mode by communication. Refer **Communication via Modbus** section for more details.

The following table presents the rules to change multi-tariff control mode by Modbus command:

From	To
Disable	Communication Digital input
RTC	Communication
Communication	Disable

## DI control mode (PM3255)

In the DI control mode, the tariff switching is triggered by the change in input status of DI. Refer Digital inputs (PM3255), page 23 for more details.

**NOTE:**

- If you change DI mode to other operation modes (normal input status, input metering, or energy reset) while multi-tariff control mode is in DI control mode, the multi-tariff function is automatically disabled.
- If you change multi-tariff control mode to other control modes (communication or internal RTC) while DI is configured for multi-tariff function, the DI operation mode automatically changes to normal input status.

## Communication control mode (PM3250 / PM3255)

In the communication control mode, the tariff switching is triggered by command number 2008. Refer **Communication via Modbus** section for more details.

## Real-time clock (RTC) control mode

In RTC control mode, the tariff switching is triggered by the real-time clock.

You can configure RTC control mode by using the display. The configuration includes the selection of schedule mode and the setup of 1 or 2 schedulers depending on the schedule modes.

The 2 schedule modes for RTC trigger are:

- **Day mode:** weekdays and weekend share the same peak and peak-off duration and only 1 scheduler should be set.
- **Week mode:** the tariff management of weekdays and weekends are controlled separately, and 2 schedulers should be set.

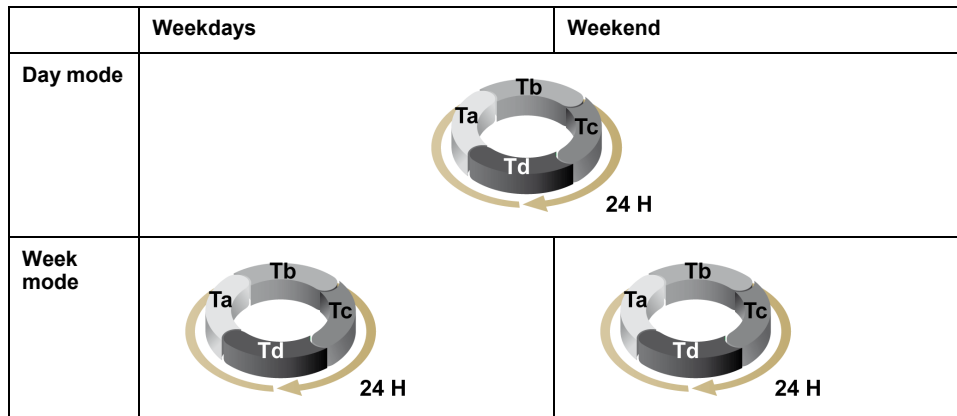

A scheduler supports a maximum of 4 time segments (Ta, Tb, Tc, and Td) for maximum 4 tariffs (T1, T2, T3, and T4). You can assign Ta, Tb, Tc, or Td to any tariff if any adjacent time segment has a different tariff. A valid scheduler always starts from Ta segment, and skipping time segments is not allowed.

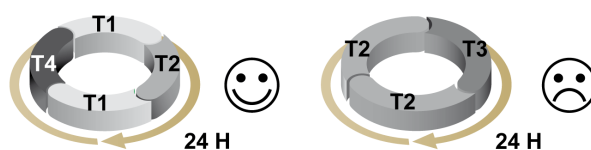

In the setup of a schedule, you should define the tariff switching time for each target tariff. In the application, when the set switching time is reached, the tariff switches automatically.

## Data logging (PM3255)

### Energy log

The meter provides energy logs. Energy day log can be read as a log file. The 3 types of energy log can be read as registers.

The following table lists the maximum number of entries of each log:

Log type	Maximum entries stored
Energy log (daily)	45
Energy log (weekly)	30
Energy log (monthly)	13

The meter has the log for accumulated active energy.

The energy log entry structure is shown in the following table:

Log Entry	Log date / time 4 registers	Energy value 4 registers
-----------	-----------------------------	--------------------------

The 3 log types are:

- **Day:** The log interval is 1 day. The logging occurs at 8:00 A.M. every day and the accumulated active energy for the previous 24 hours is logged.
- **Week:** The log interval is 1 week. The logging occurs at 8:00 A.M. every Sunday and the accumulated active energy for the previous week is logged.
- **Month:** The log interval is 1 month. The logging occurs at 8:00 A.M. on the first day of each month and the accumulated active energy for the previous month is logged.

You must use the display to configure the energy log. The day log, week log, and month log are enabled or disabled together during the configuration. However, the

energy accumulation always starts from the fixed log time instead of the time of log enabled.

You can access day log, week log, and month log by reading the registers.

**NOTE:**

- If the date/time is not set by the user after the date/time resets due to previous power interruption, energy keeps accumulating. After the date/time is set and the log time is reached, all the accumulated energy is written into the log.
- If you reset the date, the log entries with log date after the reset date are not erased.
- When the log time is reached, the meter checks the enable/disable status of the energy log. The meter logs the accumulated energy if the status is enabled and discards if the status is disabled. The accumulated energy resets to 0.
- The energy log is circular. If the number of the log entries exceeds the maximum, the oldest log entries are overwritten.

## Flex log

The meter has the following list of flex logs:

Log type	Maximum entries stored
Flex log (power demand log)	4608
Flex log (KWH_KVAH)	2336
Flex log (KWH_KVARH)	2336
Flex log (KVARH_KVAH)	2336
Flex log (KWH_KW)	2336
Flex log (KWH_KVA)	2336

The following table describes the flex log types and format. The date and time recorded in the log are accurate as per the meter's internal clock.

Flex Log (KWH_KVAH / KWH_KVARH / KVARH_KVAH / KWH_KW / KWH_KVA)			
Log type	Log date/time	Log value1	Log value2
KWH_KVAH	4 registers	2 registers (KWH)	2 registers (KVAH)
KWH_KVARH	4 registers	2 registers (KWH)	2 registers (KVARH)
KVARH_KVAH	4 registers	2 registers (KVARH)	2 registers (KVAH)
KWH_KW	4 registers	2 registers (KWH)	2 registers (KW)
KWH_KVA	4 registers	2 registers (KWH)	2 registers (KVA)

The first 4 registers of the record provide the timestamp, the next 2 registers provide the first value (for example, kWh in the KWH\_KVAH flex log), and the last 2 registers provide the second value (for example, kVAh in the KWH\_KVAH flex log).

The data format of the values from the flex log depends on the values you configured the flex log to provide.

- Energy values are provided in Float32
- Peak demand values are provided in Float32

**NOTE:**

- Only one flex log can be selected at a time. For example, you can log either power demand or KWH\_KVAH, not both.
- Synchronize the time on the meter regularly to avoid incorrect flex log timestamp values. To synchronize the time, use ION Setup.

# Meter operation

## Overview

The meter features a front panel with signaling LEDs, a graphic display, and contextual menu buttons for accessing the information required to operate the meter and modify parameter settings.

The navigation menu allows you to display, configure, and reset parameters.

## Display screen overview

A	Screen title
B	Configuration mode icon (🔧) or Error / Alert icon (⚠️/❗)
C	Cancel and go back to parent screen, Summary screen (display mode) or Setup screen (configuration mode)
D	Select a menu item or confirm an entry
E	Navigate up, select a setting from a list or increase a number in a numeric setting
F	Navigate down, select a setting from a list or decrease a number in a numeric setting
G	Values or settings
H	List of screens

## Status information

The energy pulse LED on the front panel indicate the current status of the meter.







The icons in the following table indicate the LED state:

	⊗ = OFF	⊗ = Flashing	⊗ = ON
Energy pulse LED 5000 flashes/kWh	Not counting	Energy pulse counting	Over-counting due to incorrect configuration or overload

## Backlight and diagnosis / alarm icon

The backlight (display screen) and diagnosis / alarm icon on the top right corner of the display screen indicate the meter status.

Backlight	Diagnosis / Alarm icon	Description
■ OFF	-	Device not powered ON or device is OFF
■ ON / Dim	OFF	LCD is in power saving mode.
■ ON / Normal	OFF	Normal working status.

 Backlight	 Diagnosis / Alarm icon	Description
 Flashing	 Flashing	Alarm / diagnosis is active.
<input type="checkbox"/> ON / Dim	 Flashing	Alarm / diagnosis is active for 3 hours and LCD is in power saving mode.
<input type="checkbox"/> ON / Normal <input type="checkbox"/> ON / Dim	 ON	Not active alarm. Logged alarms are not acknowledged by the user.

## Configuration mode

### Overview

The following settings can be configured in configuration mode:

Function	PM3200	PM3210	PM3250	PM3255
Wiring	√	√	√	√
CT and VT ratio	√	√	√	√
Nominal frequency	√	√	√	√
Date / Time	√	√	√	√
Multi-tariffs	√	√	√	√
Demand	√	√	√	√
Log	–	–	–	√
Digital outputs	–	–	–	√
Digital inputs	–	–	–	√
Pulse output	–	√	–	–
Communication	–	–	√	√
Password (High and Low)	√	√	√	√
Alarms	–	√	√	√
Front panel display	√	√	√	√
Language	√	√	√	√

### Default configuration mode settings

Function	Factory settings
Wiring	3PH4W; VT Direction connection; 3 CTs on I1, I2, and I3
CT Ratio	CT Secondary = 5 A; CT Primary = 5 A
VT Ratio	NA
Nominal frequency	50 Hz
Nominal phase order	A-B-C
Date / Time	1-Jan-2000/00:00:00
Multi-tariffs	Disable
Demand	Method: sliding block; Interval: 15 minutes

Function	Factory settings
Power demand log	Disable
Energy log	Disable
Digital outputs	Disable
Digital inputs	Input status
Pulse output	100 pulse/kWh, pulse width: 100 ms
Communication	Baud Rate = 19200; Parity = Even; Address = 1
Password	High: 0010; Low: 0000
Alarms	Disable
Front panel display LCD	Backlight: 4; Contrast: 5
Front panel display mode	Full screen: Enable; Auto scroll: Disable
Language	English

## Entering configuration mode

1. Press and hold **OK** and **ESC** at the same time for 2 seconds.
2. Enter the meter password. The **Access Counter** screen displays, indicating the number of times the configuration mode has been accessed.

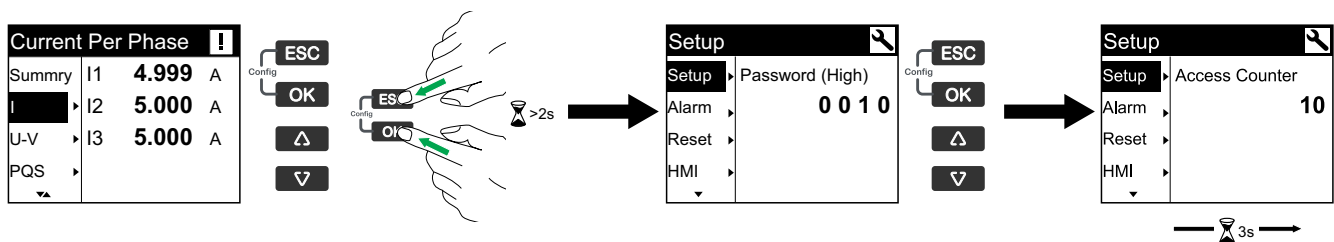

## Modifying parameters

There are two methods for modifying a parameter, depending on the type of parameter:

- Selecting a value in a list (for example, selecting 1PH2W L-N from a list of available power systems), or
- Modifying a numerical value, digit by digit (for example, entering a value for the date, time or VT primary).

**NOTE:** Before you modify any parameters, ensure that you are familiar with the HMI functionality and navigation structure of your device in configuration mode.

## Selecting a value from a list

1. Use the **▼** or **▲** button to scroll through the parameter values until you reach the desired value.
2. Press **OK** to confirm the new parameter value.

## Modifying a numerical value

When you modify a numerical value, the digit on the far right side is selected by default (except for Date/Time). The following parameters are the only ones for which you set a numerical value:

- Date
- Time
- VT primary
- CT primary
- Password
- Modbus address of the meter
- Pickup setpoint
- Dropout setpoint
- Time delay / Interval duration

To modify a numerical value:

1. Use the **▼** or **▲** button to modify the selected digit.
2. Press **OK** to confirm the new parameter value and to shift to the next digit. Modify the next digit, if needed, or press **OK**.
3. Continue to move through the digits until you reach the last digit then press **OK** again to confirm the new parameter value.

**NOTE:** If you enter an invalid setting and press **OK** cursor stays in the field for that parameter until you enter a valid value.

## Cancelling an entry

To cancel the current entry, press the **ESC** button. The change is canceled and the screen reverts to the previous display.

## Clock setting

You must reset the time to account for any time change (for example, to switch the time from standard time to daylight savings time).

## Clock behavior

You are prompted to set the date and time when the meter is powered up first time. Press **ESC** to skip this step if you do not want to set the clock (you can enter configuration mode and set the date and time later, if required).

## Date/time format

The date is displayed in the following format: DD-MMM-YYYY.

The time is displayed using the 24-hour clock in the following format: hh:mm:ss.

## Setting the clock using the display

The following image illustrates how to set the clock when you initially power up the meter or after a power failure. To set the clock during normal operation, refer to the **Configuration mode menu tree** for your meter.



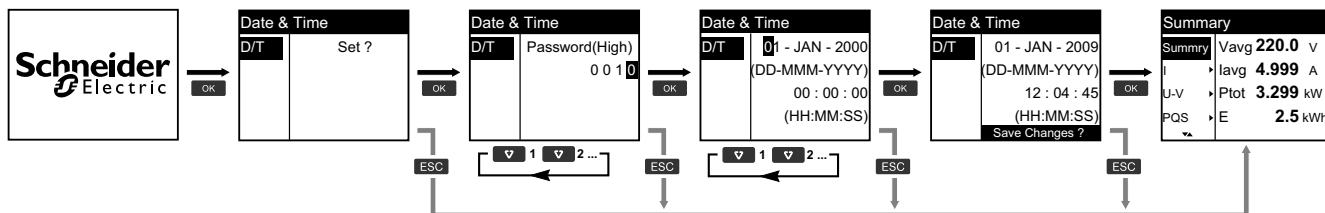

1. Press **OK** when you are prompted to set the date and time when the meter is powered up.
2. Use the **▼** or **▲** button to enter the meter **Password (High)** (Default is “0010”) and press **OK**.
3. Use the **▼** or **▲** button to set the date in **DD-MMM-YYYY** format and time in **HH:MM:SS** format.
4. Press **OK** to save your changes to the meter.

## Configuration mode menu trees

### Configuration mode menu tree for PM3200

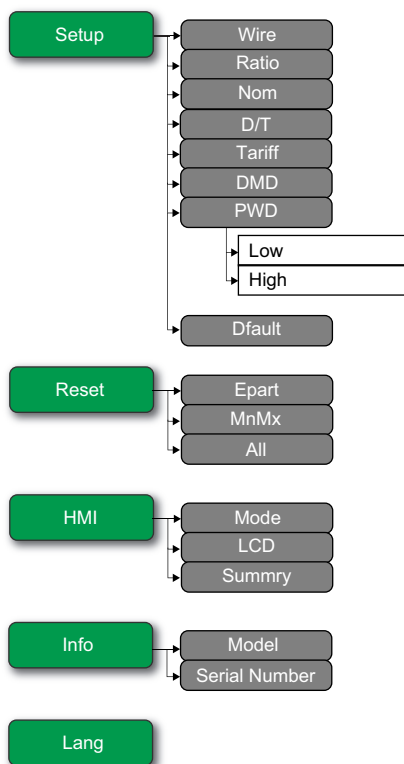

## Configuration mode menu tree for PM3210

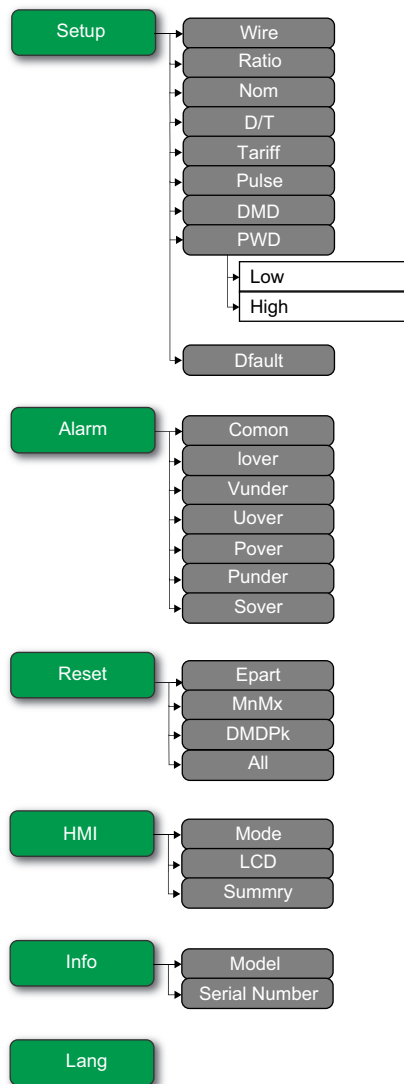

## Configuration mode menu tree for PM3250

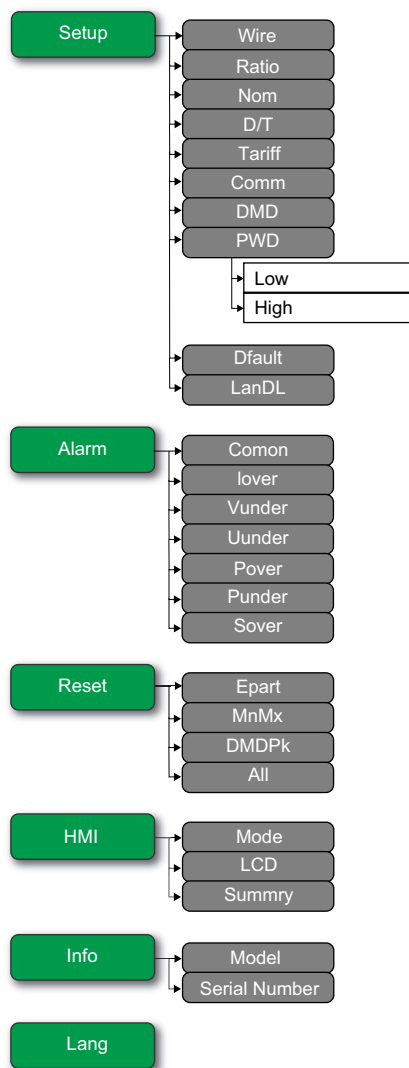

# Configuration mode menu tree for PM3255

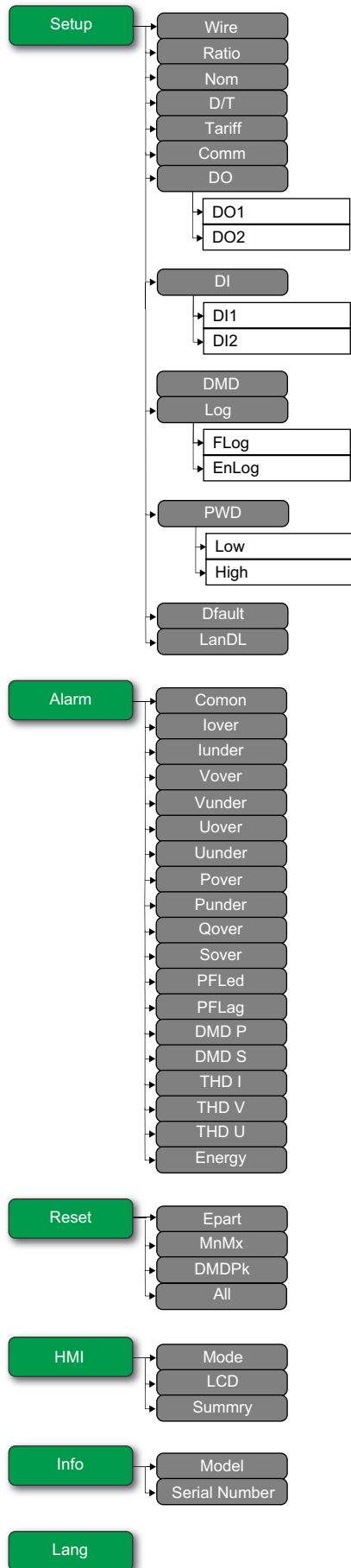

# Display mode

## Entering the display mode

- If full screen mode is enabled, press any key to switch from full screen mode to display mode.
- If full screen mode is disabled, press **ESC** to switch from configuration mode (**Setup** page) to display mode.

## Display mode menu tree for PM3200

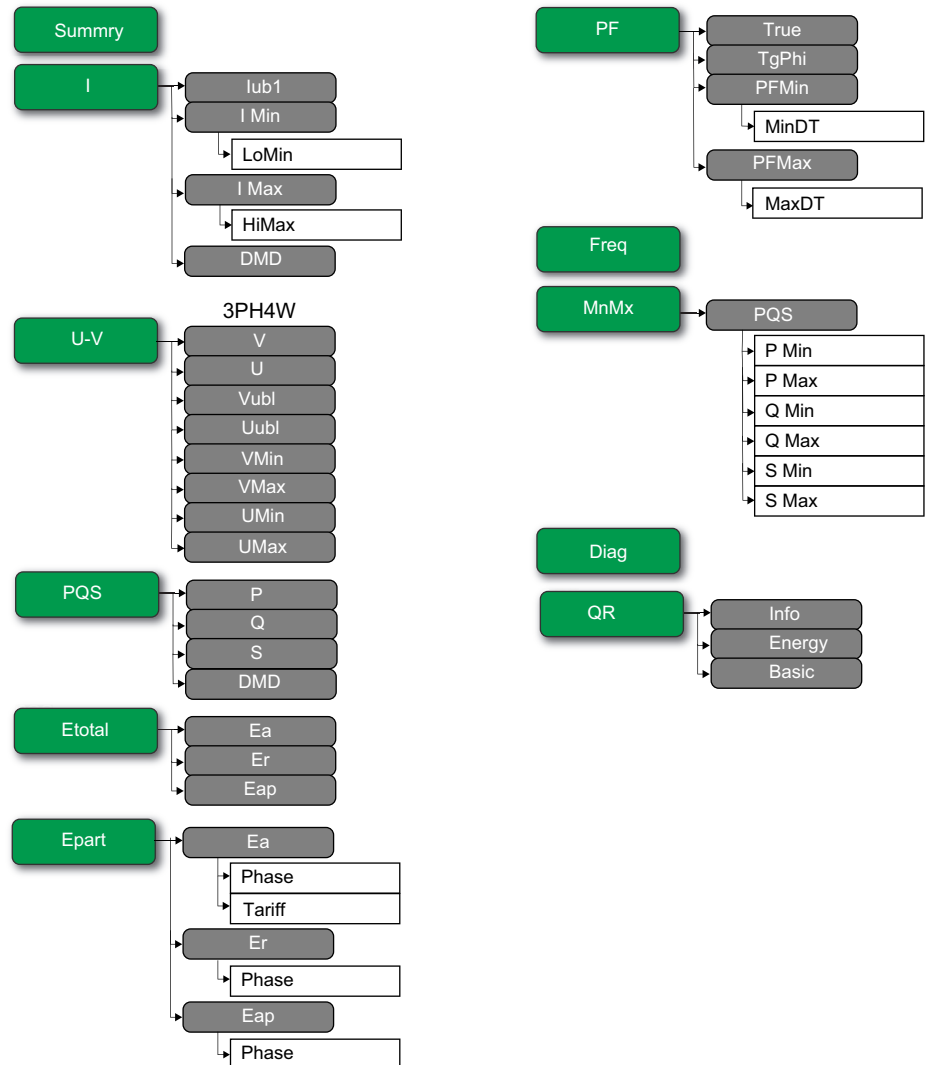

# Display mode menu tree for PM3210 / PM3250 / PM3255

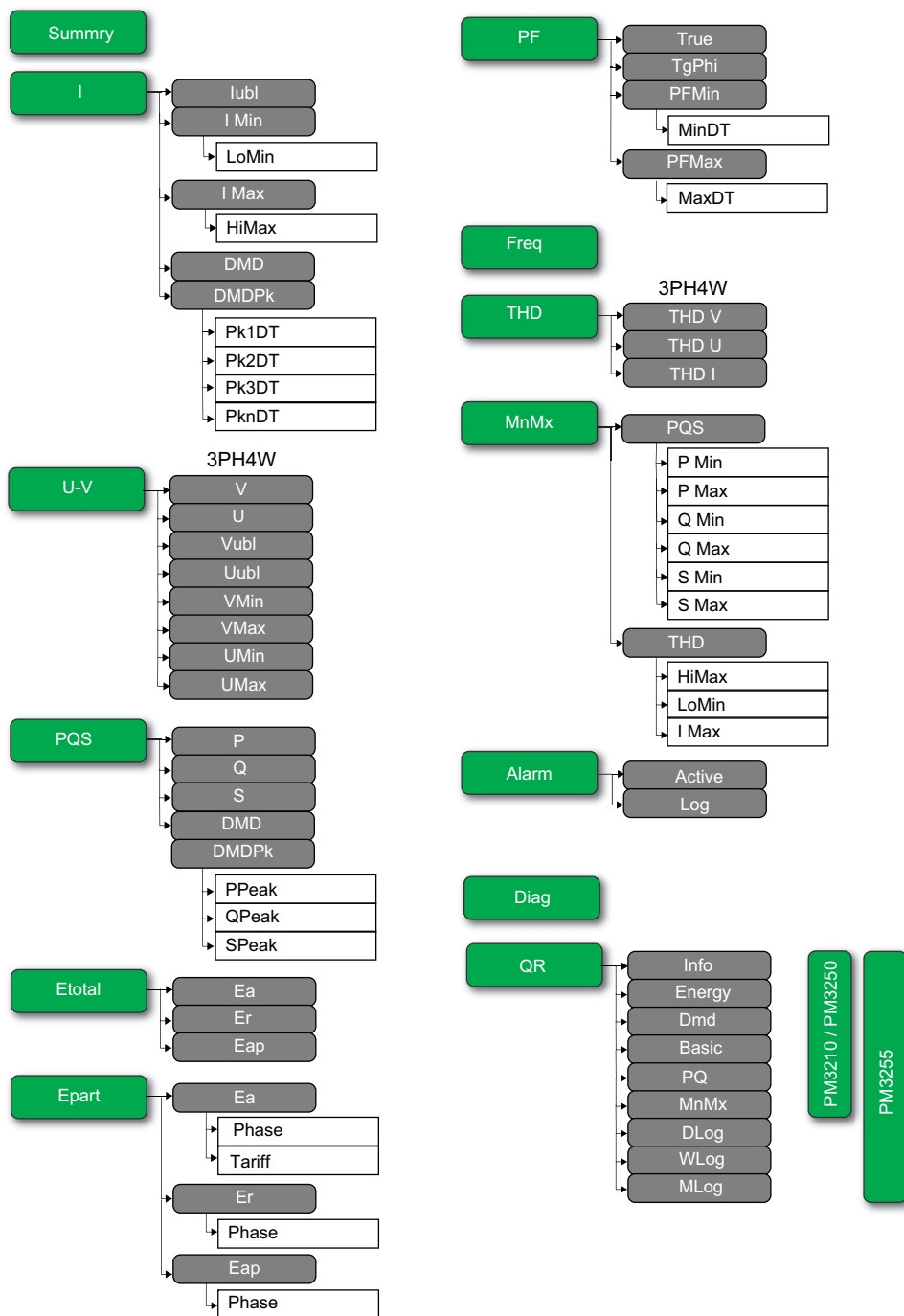

## Full screen mode

### Overview

The main title and the sub menu in full screen mode are hidden and the values are expanded to full screen.

Vavg	<b>220.0</b>	V
Iavg	<b>4.999</b>	A
Ptot	<b>3.299</b>	kW
Ea	<b>17.0</b>	Wh

The full screen mode is enabled by default. You can modify full screen enable/disable, auto scroll enable/disable, and auto scroll interval.

**NOTE: When full screen mode is enabled, the backlight is always ON and when full screen mode is disabled, the backlight goes to power saving mode.**

Full screen	Auto scroll	Auto scroll interval	Description
Enable	Disable	Any value	Fixed summary page at full screen mode.
Enable	Enable	Any value	Auto scrolling pages at full screen mode. The interval between any 2 scrolling pages is the value specified in seconds.
Disable	–	–	Full screen mode disabled.

## Entering the full screen mode

- If full screen mode is enabled, press **ESC** to switch from configuration mode (**Setup** page) to full screen mode.

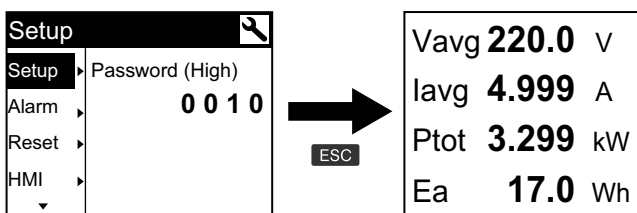

- Display mode automatically switches to full screen mode if there is no key press for five minutes.

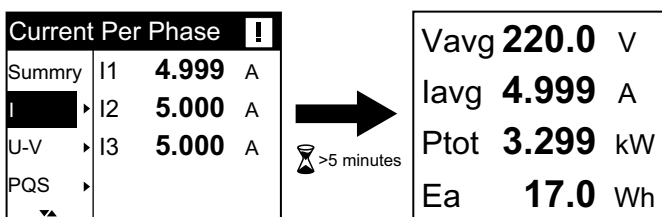

## Full screen mode menu tree for PM3200

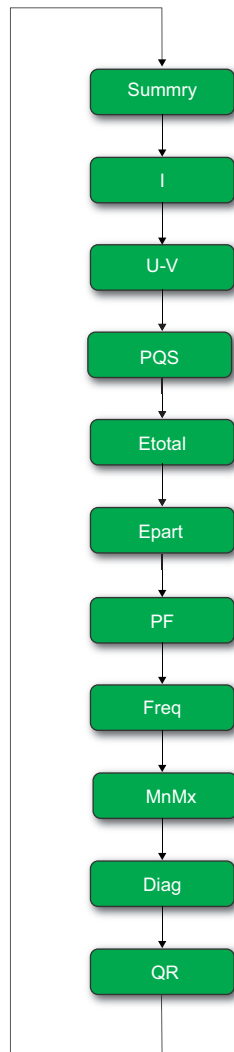



## Full screen mode menu tree for PM3210 / PM3250 / PM3255

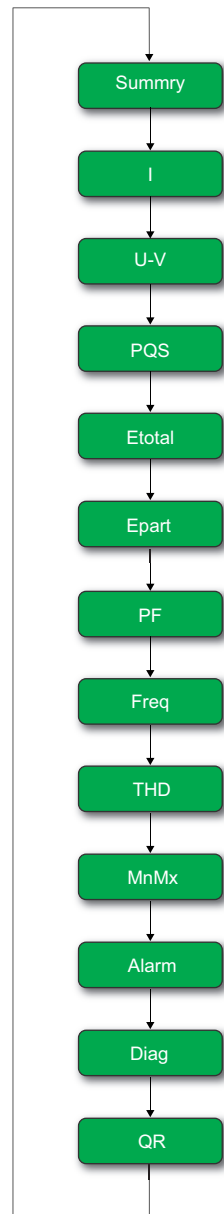

# Communication via Modbus (PM3250 / PM3255)

## Overview

The information in this section assumes that you have an advanced understanding of Modbus communications, your communications network and the power system that your meter is connected to.

There are three different ways of using Modbus communication:

- By sending commands using the command interface
- By reading the Modbus registers
- By reading Device Identification

## Modbus communications settings

Before communicating with the device using Modbus protocol, use the display to configure the following settings:

Settings	Possible values
Baud rate	9600 Baud 19200 Baud 38400 Baud
Parity	Odd Even None <b>NOTE:</b> Number of stop bits = 1
Address	1 – 247

## Communications LED indicator for Modbus devices

The yellow communications LED indicates the status of communication between the meter and the master as follows:

If...	Then...
The LED is flashing	Communication with the device has been established. <b>NOTE:</b> If there is an error online, the LED also flashes.
The LED is off	There is no active communication between the master and the slave

## Modbus functions

### Function list

The following table lists the supported Modbus functions:

Function code		Function name
Decimal	Hexadecimal	
3	0x03	Read Holding Registers
16	0x10	Write Multiple Registers
43/14	0x2B/0x0E	Read Device Identification
20	0X14	Read File Record

For example:

- To read different parameters from the meter, use function 3 (Read).
  - To change the tariff, use function 16 (Write) to send a command to the meter.
- NOTE:** The file number for flex log in the request should be 0x0001 and other elements should be as per the specifications.

To read the information about flex logs, you can use additional Modbus registers.

To read Flex log information		
Function code	1 Byte	0x14
Byte Count	1 Byte	0x07 to 0xF5 bytes
Sub-Req. x, Reference Type	1 Byte	6
Sub-Req. x, File Number	2 Bytes	0x0001
Sub-Req. x, Record Number	2 Bytes	Register (45408)
Sub-Req. x, Record Length	2 Bytes	Register (45407)

## Table format

Register tables have the following columns:

Address	Register	Action (R/W/WC)	Size	Type	Units	Range	Description
---------	----------	-----------------	------	------	-------	-------	-------------

- **Address:** A 16-bit register address in hexadecimal. The address is the data used in the Modbus frame.
- **Register:** A 16-bit register number in decimal (register = address + 1).
- **Action:** The read/write/write by command property of the register.
- **Size:** The data size in Int16.
- **Type:** The encoding data type.
- **Units:** The unit of the register value.
- **Range:** The permitted values for this variable, usually a subset of what the format allows.
- **Description:** Provides information about the register and the values that apply.

## Unit table

The following data types appear in the Modbus register list:

Type	Description	Range
UInt16	16 bit unsigned integer	0 – 65535
Int16	16 bit signed integer	-32768 to +32767
UInt32	32 bit unsigned integer	0 – 4 294 967 295

Type	Description	Range
Int64	64 bit unsigned integer	0 – 18 446 744 073 709 551 615
UTF8	8 bit field	Multibyte character encoding for Unicode
Float32	32 bit value	Standard representation IEEE for floating number (with single precision))
Bitmap	—	—
DATETIME	See below table	—

**DATETIME format:**

Word	Bits																
	15	14	13	12	11	10	9	8	7	6	5	4	3	2	1	0	
1	Reserved								R4 (0)	Year (0 – 127)							
2	0				Month (1 – 12)				WD (0)				Day (1 – 31)				
3	SU (0)	0		Hour (0 – 23)				iV	0	Minute (0 – 59)							
4	Millisecond (0 – 59999)																
R4 :								Reserved Bit									
Year :								7 bits (year from 2000)									
Month :								4 bits									
Day :								5 bits									
Hour :								5 bits									
Minute :								6 bits									
Millisecond :								2 octets									
WD (day of the week) :								1 – 7: Sunday – Saturday									
SU (summer time) :								Bit to 0 if this parameter is not used									
iV (validity of received data) :								Bit to 0 if this parameter is not valid or not used									

## Command interface

### Command interface overview

The command interface allows you to configure the meter by sending specific command requests using Modbus function 16.

### Command request

The following table describes a Modbus command request:

Slave Number	Function Code	Command block		CRC
		Register Address	Command Description	
1 – 247	16 (W)	5250 (up to 5374)	The command is made of a command number and a set of parameters. See the detailed description of each command in the command list. <b>NOTE:</b> All the reserved parameters can be considered as any value, e.g. 0.	Checking

The following table describes a command block:

Register Address	Content	Size (Int16)	Data (example)
5250	Command Number	1	2008 (Set Tariff)
5251	(Reserved)	1	0
5252 – 5374	Parameter	n	4 (Tariff = 4) <b>NOTE:</b> Command number 2008 supports only one parameter with the size of 1.

## Command Result

Register Address	Content	Size (Int16)	Data (example)
5375	Requested Command Number	1	2008 (Set Tariff)
5376	Result List of Command result codes: <ul style="list-style-type: none"> <li>• 0 = Valid Operation</li> <li>• 3000 = Invalid Command</li> <li>• 3001 = Invalid Parameter</li> <li>• 3002 = Invalid Number of Parameters</li> <li>• 3007 = Operation Not Performed</li> </ul>	1	0 (Valid Operation)

## Command list

### Set Date/Time

Command Number	Action (R/W)	Size	Type	Unit	Range	Description
1003	W	1	UInt16	—	—	(Reserved)
	W	1	UInt16	—	2000 – 2099	Year
	W	1	UInt16	—	1 – 12	Month
	W	1	UInt16	—	1 – 31	Day
	W	1	UInt16	—	0 – 23	Hour
	W	1	UInt16	—	0 – 59	Minute
	W	1	UInt16	—	0 – 59	Second
	W	1	UInt16	—	—	(Reserved)

## Set Wiring

Command Number	Action (R/W)	Size	Type	Unit	Range	Description
2000	W	1	UInt16	—	—	(Reserved)
	W	1	UInt16	—	1, 3	Number of phases
	W	1	UInt16	—	2, 3, 4	Number of wires
	W	1	UInt16	—	0, 1, 2, 3, 11, 13	Power System Configuration: 0 = 1PH2W L-N 1 = 1PH2W L-L 2 = 1PH3W L-L-N 3 = 3PH3W 11 = 3PH4W 13 = 1PH4W L-N
	W	1	UInt16	Hz	50, 60	Nominal Frequency
	W	2	Float32	—	—	(Reserved)
	W	2	Float32	—	—	(Reserved)
	W	2	Float32	—	—	(Reserved)
	W	1	UInt16	—	—	(Reserved)
	W	1	UInt16	—	—	(Reserved)
	W	2	Float32	V	VT Secondary – 1000000.0	VT Primary
	W	1	UInt16	V	100, 110, 115, 120	VT Secondary
	W	1	UInt16	—	1, 2, 3	Number of CTs
	W	1	UInt16	A	1 – 32767	CT Primary
	W	1	UInt16	A	1, 5	CT Secondary
	W	1	UInt16	—	—	(Reserved)
	W	1	UInt16	—	—	(Reserved)
	W	1	UInt16	—	—	(Reserved)
	W	1	UInt16	—	—	(Reserved)
	W	1	UInt16	—	0, 1, 2	VT Connection type: 0 = Direct Connect 1 = 3PH3W (2 VTs) 2 = 3PH4W (3 VTs)

## Demand System Setup

Command Number	Action (R/W)	Size	Type	Unit	Range	Description
2002	W	1	UInt16	—	—	(Reserved)
	W	1	UInt16	—	—	(Reserved)
	W	1	UInt16	—	1, 2	Demand method: 1 = Timed interval sliding block 2 = Timed interval fixed block
	W	1	UInt16	min	10, 15, 20, 30, 60	Demand interval duration
	W	1	UInt16	—	—	(Reserved)

## Set Pulse Output (PM3255)

Command Number	Action (R/W)	Size	Type	Unit	Range	Description
2003	W	1	UInt16	—	—	(Reserved)
	W	1	UInt16	—	—	(Reserved)
	W	1	UInt16	—	0, 1	Pulse output 0 = DO1 Disable 1 = DO1 Enable
	W	2	Float32	pulse/kWh	0.01, 0.1, 1, 10, 100, 500	Active energy pulse frequency
	W	1	UInt16	—	—	(Reserved)
	W	1	UInt16	—	0, 2	Pulse output 0 = DO2 Disable 1 = DO2 Enable
	W	2	Float32	pulse/kVARh	0.01, 0.1, 1, 10, 100, 500	Reactive energy pulse frequency
	W	1	UInt16	—	—	(Reserved)
	W	1	UInt16	—	—	(Reserved)
	W	2	Float32	—	—	(Reserved)
2038	W	1	UInt16	—	—	(Reserved)
	W	1	UInt16	—	—	(Reserved)
	W	1	UInt16	ms	50, 100, 200, 300	Energy pulse duration

## Set Tariff

Command Number	Action (R/W)	Size	Type	Unit	Range	Description
2060	W	1	UInt16	—	—	(Reserved)
	W	1	UInt16	—	0 – 4	Multi-tariff mode: 0 = Disable multi-tariff 1 = Use COM as tariff control (maximum 4 tariffs) 2 = Use 1 digital input as tariff control (2 tariffs) 3 = Use 2 digital inputs as tariff control (4 tariffs) 4 = Use RTC as tariff control (maximum 4 tariffs)
2008	W	1	UInt16	—	—	(Reserved)
	W	1	UInt16	—	1 – 4	Tariff: <b>NOTE:</b> Only if multi-tariff is controlled by communications 1 = T1 2 = T2 3 = T3 4 = T4

## Reset All Minimum/Maximum

Command Number	Action (R/W)	Size	Type	Unit	Range	Description
2009	W	1	UInt16	—	—	(Reserved)

### Reset All Peak Demands

Command Number	Action (R/W)	Size	Type	Unit	Range	Description
2015	W	1	UInt16	—	—	(Reserved)

### Set Digital Input as Partial Energy Reset (PM3255)

Command Number	Action (R/W)	Size	Type	Unit	Range	Description
6017	W	1	UInt16	—	—	(Reserved)
	W	1	UInt16	—	0 – 3	Digital input to associate: 0 = None 1 = DI1 2 = DI2 3 = DI1 and DI2

### Input Metering Setup (PM3255)

Command Number	Action (R/W)	Size	Type	Unit	Range	Description
6014	W	1	UInt16	—	—	(Reserved)
	W	1	UInt16	—	1, 2	Input metering channel
	W	20	UTF8	—	string size ≤ 40	Label
	W	2	Float32	—	1 – 10000	Pulse weight
	W	1	UInt16	—	—	(Reserved)
	W	1	UInt16	—	Input metering channel 1: 0, 1 Input metering channel 2: 0, 2	Digital input association: 0 = None 1 = DI1 2 = DI2

### Alarm Setup

Command Number	Action (R/W)	Size	Type	Unit	Range	Description
7000	W	1	UInt16	—	—	(Reserved)
	W	1	UInt16	—	<b>PM3250 :</b> 1, 6, 8, 9, 11, 30 <b>PM3255 :</b> 1, 2, 5 – 16, 19, 28, 30 – 32, 41	Alarm ID
	W	1	UInt16	—	—	(Reserved)
	W	1	UInt16	—	—	(Reserved)
	W	1	UInt16	—	—	(Reserved)
	W	1	UInt16	—	0, 1	0 = Disable 1 = Enable
	W	2	Float32	—	<b>Alarm ID 1, 2, 5, 6, 7, 8, 11, 19:</b> 0.0 – 9999999.0 <b>Alarm ID 9, 10, 16, 30:</b> -9999999.0 – 9999999.0 <b>Alarm ID 12, 13:</b> -2.0 – 2.0	Pickup setpoint



Command Number	Action (R/W)	Size	Type	Unit	Range	Description
					<b>Alarm ID 28, 31, 32:</b> 0.0 – 1000.0 <b>Alarm ID 41:</b> 0 – 999999999	
	W	2	UInt32	—	—	(Reserved)
	W	2	Float32	—	—	(Reserved)
	W	2	UInt32	—	—	(Reserved)
	W	1	UInt16	—	—	(Reserved)
	W	4	UInt16	—	—	(Reserved)
	W	1	UInt16	—	—	(Reserved)
20000	W	1	UInt16	—	—	(Reserved)
	W	2	Float32	—	0.0 – 99.0	Dropout setpoint
	W	2	UInt32	—	0 – 999999	Trip time delay
	W	1	Bitmap	—	0, 1, 2, 3	PM3250 : Reserved PM3255 : Digital output to associate 0 = None 1 = DO1 2 = DO2 3 = DO1 and DO2
20001	W	1	UInt16	—	—	(Reserved)

## Communications Setup

Command Number	Action (R/W)	Size	Type	Unit	Range	Description
5000	W	1	UInt16	—	—	(Reserved)
	W	1	UInt16	—	—	(Reserved)
	W	1	UInt16	—	—	(Reserved)
	W	1	UInt16	—	1 – 247	Address
	W	1	UInt16	—	0, 1, 2	Baud Rate: 0 = 9600 1 = 19200 2 = 38400
	W	1	UInt16	—	0, 1, 2	Parity: 0 = Even 1 = Odd 2 = None
	W	1	UInt16	—	—	(Reserved)

## Reset Partial Energy Counters

Command Number	Action (R/W)	Size	Type	Unit	Range	Description
2020	W	1	UInt16	—	—	(Reserved)

## Reset Input Metering Counter (PM3255)

Command Number	Action (R/W)	Size	Type	Unit	Range	Description
2023	W	1	UInt16	—	—	(Reserved)

## Set External Control from Digital Output (PM3255)

Command Number	Action (R/W)	Size	Type	Unit	Range	Description
21000	W	1	UInt16	—	—	(Reserved)
	W	1	UInt16	—	1, 2	Digital output ID 1 = DO1 2 = DO2
	W	1	UInt16	—	0, 1	Digital output status 0 = Open 1 = Close

## Set Flex Log

Command Number	Action (R/W)	Size	Type	Unit	Range	Description
2052	W	1	UInt16	—	0 – 6	Flex log mode: 0 = Disable 1 = Peak demand 2 = KWH_KVAH 3 = KWH_KVARH 4 = KVARH_KVAH 5 = KWH_KW 6 = KWH_KVA
	W	1	UInt16	—	10, 15, 20, 30, 60	Flex log interval duration in minutes: 10, 15, 20, 30, 60
	W	1	UInt16	—	1, 2	0 = Open 1 = Close <b>NOTE:</b> Applies only when flex log mode is set to peak demand

## Modbus register list

### System

Address	Register	Action (R/W/WC)		Size	Type	Units	Description
		PM3250	PM3255				
0x001D	30	R	R	20	UTF8	—	Meter Name
0x0031	50	R	R	20	UTF8	—	Meter Model
0x0045	70	R	R	20	UTF8	—	Manufacturer
0x0081	130	R	R	2	UInt32	—	Serial Number
0x0083	132	R	R	4	DATETIME	—	Date of Manufacture

Address	Register	Action (R/W/WC)		Size	Type	Units	Description
		PM3250	PM3255				
0x0087	136	R	R	5	UTF8	—	Hardware Revision
0x0664	1637	R	R	1	UInt16	—	Present Firmware Version (DLF format): X.Y.ZTT
0x06A4	1701	R	R	1	UInt16	—	Present Language Version (DLF format): X.Y.ZTT
0x0734 – 0x0737	1845 – 1848	R/WC	R/WC	1 X 4	UInt16	—	Date/Time: Reg. 1845: Year (b6:b0) 0 – 99 (year from 2000 to 2099) Reg. 1846: Month (b11:b8), Weekday (b7:b5), Day (b4:b0) Reg. 1847: Hour (b12:b8), Minute (b5:b0) Reg. 1848: Millisecond

## Meter Setup and Status

Address	Register	Action (R/W/WC)		Size	Type	Units	Description
		PM3250	PM3255				
0x6A4D	27214	R	R	4	DATETIME	—	Minimum/Maximum Reset Date/Time

## Energy Pulse Output Setup

Address	Register	Action (R/W/WC)		Size	Type	Units	Description
		PM3250	PM3255				
Energy Output Pulses (Global Settings)							
0x0850	2129	—	R/WC	1	UInt16	Millisecond	Energy Pulse Duration
Active Energy Pulse Output Channel							
0x0852	2131	—	R/WC	1	UInt16	—	Digital Output Association: 0 = Disable 1 = DO1 enable for active energy pulse output
0x0853	2132	—	R/WC	2	Float32	pulse/kWh	Active Energy Pulse Frequency
Reactive Energy Pulse Output Channel							
0x0856	2135	—	R/WC	1	UInt16	—	Digital Output Association: 0 = Disable 1 = DO2 enable for reactive energy pulse output
0x0857	2136	—	R/WC	2	Float32	pulse/kVARh	Reactive Energy Pulse Frequency

## Command Interface

Address	Register	Action (R/W/WC)		Size	Type	Units	Description
		PM3250	PM3255				
0x1481	5250	R/W	R/W	1	UInt16	—	Requested Command
0x1483	5252	R/W	R/W	1	UInt16	—	Command Parameter 001
0x14FD	5374	R/W	R/W	1	UInt16	—	Command Parameter 123

Address	Register	Action (R/W/WC)		Size	Type	Units	Description
		PM3250	PM3255				
0x14FE	5375	R	R	1	UInt16	—	Command Status
0x14FF	5376	R	R	1	UInt16	—	Command Result codes: 0 = Valid Operation 3000 = Invalid Command 3001 = Invalid Parameter 3002 = Invalid Number of Parameters 3007 = Operation Not Performed
0x1500	5377	R/W	R/W	1	UInt16	—	Command Data 001
0x157A	5499	R	R	1	UInt16	—	Command Data 123

## Communications

Address	Register	Action (R/W/WC)		Size	Type	Units	Description
		PM3250	PM3255				
0x1963	6500	R	R	1	UInt16	—	Protocol 0 = Modbus
0x1964	6501	R/WC	R/WC	1	UInt16	—	Address
0x1965	6502	R/WC	R/WC	1	UInt16	—	Baud Rate: 0 = 9600 1 = 19200 2 = 38400
0x1966	6503	R/WC	R/WC	1	UInt16	—	Parity: 0 = Even 1 = Odd 2 = None

## Input Metering Setup

Address	Register	Action (R/W/WC)		Size	Type	Units	Description
		PM3250	PM3255				
Input Metering Channel 01							
0x1B77	7032	—	R/WC	20	UTF8	—	Label
0x1B8B	7052	—	R/WC	2	Float32	pulse/unit	Pulse Frequency
0x1B8E	7055	—	R/WC	1	UInt16	—	Digital Input Association: 0 = DI1 disable for input metering 1 = DI1 enable for input metering
Input Metering Channel 02							
0x1B8F	7056	—	R/WC	20	UTF8	—	Label
0x1BA3	7076	—	R/WC	2	Float32	pulse/unit	Pulse Frequency
0x1BA6	7079	—	R/WC	1	UInt16	—	Digital Input Association: 0 = DI2 disable for input metering 2 = DI2 enable for input metering

## Digital Inputs

Address	Register	Action (R/W/WC)		Size	Type	Units	Description
		PM3250	PM3255				
0x1C69	7274	—	R	1	UInt16	—	Digital Input 1 Control Mode: 0 = Normal (Input Status) 2 = Multi-tariff Control 3 = Input Metering 5 = Energy Reset (Partial Energy, Energy by Tariff, Phase Energy)
0x1C81	7298	—	R	1	UInt16	—	Digital Input 2 Control Mode
0x22C8	8905	—	R	2	Bitmap	—	Digital Input Status: 0 = Relay-Open 1 = Relay-Closed Bit 1 = DI1 status Bit 2 = DI2 status

## Digital Outputs

Address	Register	Action (R/W/WC)		Size	Type	Units	Description
		PM3250	PM3255				
0x25C8	9673	—	R	1	UInt16	—	Digital Output 1 Control Mode Status: 2 = Alarm 3 = Energy 0xFFFF = Disable
0x25D0	9681	—	R	1	UInt16	—	Digital Output 2 Control Mode Status
0x25C2	9667	—	R	2	Bitmap	—	Digital Output Status: 0 = Relay-Open 1 = Relay-Closed Bit 1 = DO1 status Bit 2 = DO2 status

## Basic Meter Data

### Current, voltage, power, power factor and frequency

Address	Register	Action (R/W/WC)		Size	Type	Units	Description
		PM3250	PM3255				
<b>Current</b>							
0x0BB7	3000	R	R	2	Float32	A	I1: phase 1 current
0x0BB9	3002	R	R	2	Float32	A	I2: phase 2 current
0x0BBB	3004	R	R	2	Float32	A	I3: phase 3 current
0x0BBD	3006	R	R	2	Float32	A	In: Neutral current
0x0BC1	3010	R	R	2	Float32	A	Current Avg
<b>Voltage</b>							
0x0BCB	3020	R	R	2	Float32	V	Voltage L1-L2

Address	Register	Action (R/W/WC)		Size	Type	Units	Description
		PM3250	PM3255				
0x0BCD	3022	R	R	2	Float32	V	Voltage L2-L3
0x0BCF	3024	R	R	2	Float32	V	Voltage L3-L1
0x0BD1	3026	R	R	2	Float32	V	Voltage L-L Avg
0x0BD3	3028	R	R	2	Float32	V	Voltage L1-N
0x0BD5	3030	R	R	2	Float32	V	Voltage L2-N
0x0BD7	3032	R	R	2	Float32	V	Voltage L3-N
0x0BDB	3036	R	R	2	Float32	V	Voltage L-N Avg
<b>Power</b>							
0x0BED	3054	R	R	2	Float32	kW	Active Power Phase 1
0x0BEF	3056	R	R	2	Float32	kW	Active Power Phase 2
0x0BF1	3058	R	R	2	Float32	kW	Active Power Phase 3
0x0BF3	3060	R	R	2	Float32	kW	Total Active Power
0x0BF5	3062	R	R	2	Float32	kVAR	Reactive Power Phase 1
0x0BF7	3064	R	R	2	Float32	kVAR	Reactive Power Phase 2
0x0BF9	3066	R	R	2	Float32	kVAR	Reactive Power Phase 3
0x0BFB	3068	R	R	2	Float32	kVAR	Total Reactive Power
0x0BFD	3070	R	R	2	Float32	kVA	Apparent Power Phase 1
0x0BFF	3072	R	R	2	Float32	kVA	Apparent Power Phase 2
0x0C01	3074	R	R	2	Float32	kVA	Apparent Power Phase 3
0x0C03	3076	R	R	2	Float32	kVA	Total Apparent Power
<b>Power Factor</b>							
0x0C05	3078	R	R	2	Float32	—	Power Factor Phase 1 (Complex format)
0x0C07	3080	R	R	2	Float32	—	Power Factor Phase 2 (Complex format)
0x0C09	3082	R	R	2	Float32	—	Power Factor Phase 3 (Complex format)
0x0C0B	3084	R	R	2	Float32	—	Power Factor Total: -2 < PF < -1 = Quad 2, active power negative, capacitive -1 < PF < 0 = Quad 3, active power negative, inductive 0 < PF < 1 = Quad 1, active power positive, inductive 1 < PF < 2 = Quad 4, active power positive, capacitive
<b>Current Unbalance</b>							
0x0BC3	3012	R	R	2	Float32	%	Current Unbalance I1
0x0BC5	3014	R	R	2	Float32	%	Current Unbalance I2
0x0BC7	3016	R	R	2	Float32	%	Current Unbalance I3
0x0BC9	3018	R	R	2	Float32	%	Current Unbalance Worst
<b>Voltage Unbalance</b>							
0x0BDD	3038	R	R	2	Float32	%	Voltage Unbalance L1-L2
0x0BDF	3040	R	R	2	Float32	%	Voltage Unbalance L2-L3
0x0BE1	3042	R	R	2	Float32	%	Voltage Unbalance L3-L1
0x0BE3	3044	R	R	2	Float32	%	Voltage Unbalance L-L Worst
0x0BE5	3046	R	R	2	Float32	%	Voltage Unbalance L1-N
0x0BE7	3048	R	R	2	Float32	%	Voltage Unbalance L2-N

Address	Register	Action (R/W/WC)		Size	Type	Units	Description
		PM3250	PM3255				
0x0BE9	3050	R	R	2	Float32	%	Voltage Unbalance L3-N
0x0BEB	3052	R	R	2	Float32	%	Voltage Unbalance L-N Worst
<b>Tangent Phi (Reactive Factor)</b>							
0x0C23	3108	R	R	2	Float32	—	Tangent Phi, Total
<b>Frequency</b>							
0x0C25	3110	R	R	2	Float32	Hz	Frequency
<b>Temperature</b>							
0x0C3B	3132	R	R	2	Float32	°C	Temperature

## Energy, energy by tariff and input metering

Most energy values are available in both signed 64-bit integer and 32-bit floating point format.

Resets and active tariff information							
Address	Register	Action (R/W/WC)		Size	Type	Units	Description
		PM3250	PM3255				
<b>Energy Reset (Partial Energy, Energy by Tariff, Phase Energy)</b>							
0x0CB3	3252	R	R	4	DATETIME	—	Energy Reset Date/Time
<b>Energy by Tariff Import</b>							
0x105E	4191	R/WC	R/WC	1	UInt16	—	Active Tariff (Only modifiable in case of COM Control Mode Enabled): 0 = multi-tariff disabled 1-4 = rate 1 to rate 4
<b>Input Metering</b>							
0x0DE1	3554	—	R	4	DATETIME	—	Input Metering Accumulation Reset Date/Time

Energy values – 64-bit integer							
Address	Register	Action (R/W/WC)		Size	Type	Units	Description
		PM3250	PM3255				
<b>Total Energy</b>							
0x0C83	3204	R	R	4	Int64	Wh	Total Active Energy Import
0x0C87	3208	R	R	4	Int64	Wh	Total Active Energy Export
0x0C93	3220	R	R	4	Int64	VARh	Total Reactive Energy Import
0x0C97	3224	R	R	4	Int64	VARh	Total Reactive Energy Export
0x0CA3	3236	R	R	4	Int64	VAh	Total Apparent Energy Import
0x0CA7	3240	R	R	4	Int64	VAh	Total Apparent Energy Export
<b>Energy Reset (Partial Energy, Energy by Tariff, Phase Energy)</b>							
0x0CB3	3252	R	R	4	DATETIME	—	Energy Reset Date/Time
<b>Partial Energy Import</b>							
0x0CB7	3256	R	R	4	Int64	Wh	Partial Active Energy Import
0x0CC7	3272	R	R	4	Int64	VARh	Partial Reactive Energy Import
0x0CD7	3288	R	R	4	Int64	VAh	Partial Apparent Energy Import

Energy values – 64-bit integer							
Address	Register	Action (R/W/WC)		Size	Type	Units	Description
		PM3250	PM3255				
<b>Phase Energy Import</b>							
0x0DBD	3518	R	R	4	Int64	Wh	Active Energy Import Phase 1
0x0DC1	3522	R	R	4	Int64	Wh	Active Energy Import Phase 2
0x0DC5	3526	R	R	4	Int64	Wh	Active Energy Import Phase 3
0x0DC9	3530	R	R	4	Int64	VARh	Reactive Energy Import Phase 1
0x0DCD	3534	R	R	4	Int64	VARh	Reactive Energy Import Phase 2
0x0DD1	3538	R	R	4	Int64	VARh	Reactive Energy Import Phase 3
0x0DD5	3542	R	R	4	Int64	VAh	Apparent Energy Import Phase 1
0x0DD9	3546	R	R	4	Int64	VAh	Apparent Energy Import Phase 2
0x0DDD	3550	R	R	4	Int64	VAh	Apparent Energy Import Phase 3
<b>Energy by Tariff Import</b>							
0x1063	4196	R	R	4	Int64	Wh	Rate 1 Active Energy Import
0x1067	4200	R	R	4	Int64	Wh	Rate 2 Active Energy Import
0x106B	4204	R	R	4	Int64	Wh	Rate 3 Active Energy Import
0x106F	4208	R	R	4	Int64	Wh	Rate 4 Active Energy Import
<b>Input Metering</b>							
0xDE1	3554	—	R	4	DATEIME	—	Input Metering Accumulation Reset Date/Time
0xDE5	3558	—	R	4	Int64	Unit	Input Metering Accumulation Channel 01
0xDE9	3562	—	R	4	Int64	Unit	Input Metering Accumulation Channel 02

Energy values – 32-bit floating point							
Address	Register	Action (R/W/WC)		Size	Type	Units	Description
		PM3250	PM3255				
<b>Total Energy</b>							
0xB06D	45166	R	R	2	Float32	Wh	Total Active Energy Import
0xB06F	45168	R	R	2	Float32	Wh	Total Active Energy Export
0xB071	45170	R	R	2	Float32	VARh	Total Reactive Energy Import
0xB073	45172	R	R	2	Float32	VARh	Total Reactive Energy Export
0xB075	45174	R	R	2	Float32	VAh	Total Apparent Energy Import
0xB077	45176	R	R	2	Float32	VAh	Total Apparent Energy Export
<b>Partial Energy Import</b>							
0xB079	45178	R	R	2	Float32	Wh	Partial Active Energy Import
0xB07B	45180	R	R	2	Float32	VARh	Partial Reactive Energy Import
0xB07D	45182	R	R	2	Float32	VAh	Partial Apparent Energy Import
<b>Phase Energy Import</b>							
0xB07F	45184	R	R	2	Float32	Wh	Active Energy Import Phase 1
0xB081	45186	R	R	2	Float32	Wh	Active Energy Import Phase 2
0xB083	45188	R	R	2	Float32	Wh	Active Energy Import Phase 3
0xB085	45190	R	R	2	Float32	VARh	Reactive Energy Import Phase 1
0xB087	45192	R	R	2	Float32	VARh	Reactive Energy Import Phase 2



Energy values – 32-bit floating point							
Address	Register	Action (R/W/WC)		Size	Type	Units	Description
		PM3250	PM3255				
0xB089	45194	R	R	2	Float32	VARh	Reactive Energy Import Phase 3
0xB08B	45196	R	R	2	Float32	VAh	Apparent Energy Import Phase 1
0xB08D	45198	R	R	2	Float32	VAh	Apparent Energy Import Phase 2
0xB08F	45200	R	R	2	Float32	VAh	Apparent Energy Import Phase 3
<b>Energy by Tariff Import</b>							
0xB095	45206	R	R	2	Float32	Wh	Rate 1 Active Energy Import
0xB097	45208	R	R	2	Float32	Wh	Rate 2 Active Energy Import
0xB099	45210	R	R	2	Float32	Wh	Rate 3 Active Energy Import
0xB09B	45212	R	R	2	Float32	Wh	Rate 4 Active Energy Import
<b>Input Metering</b>							
0xB091	45202	—	R	2	Float32	Unit	Input Metering Accumulation Channel 01
0xB093	45204	—	R	2	Float32	Unit	Input Metering Accumulation Channel 02

## Demand

Address	Register	Action (R/W/WC)		Size	Type	Units	Description
		PM3250	PM3255				
<b>Demand System (Global)</b>							
0x0E74	3701	R/WC	R/WC	1	UInt16	—	Demand Method: 1 = Timed Interval Sliding Block 2 = Timed Interval Fixed Block
0x0E75	3702	R/WC	R/WC	1	UInt16	Minute	Demand Interval Duration
0x0E79	3706	R	R	4	DATETIME	—	Demand Peak Reset Date/Time
<b>Power/Current Demand</b>							
0x0EB5	3766	R	R	2	Float32	kW	Active Power Present Demand
0x0EB9	3770	R	R	2	Float32	kW	Active Power Peak Demand
0x0EBB	3772	R	R	4	DATETIME	—	Active Power Peak Demand Date/Time
0x0EC5	3782	R	R	2	Float32	kVAR	Reactive Power Present Demand
0x0EC9	3786	R	R	2	Float32	kVAR	Reactive Power Peak Demand
0x0ECB	3788	R	R	4	DATETIME	—	Reactive Power Peak Demand Date/Time
0x0ED5	3798	R	R	2	Float32	kVA	Apparent Power Present Demand
0x0ED9	3802	R	R	2	Float32	kVA	Apparent Power Peak Demand
0x0EDB	3804	R	R	4	DATETIME	—	Apparent Power Peak Demand Date/Time
0x0EE5	3814	R	R	2	Float32	A	Current I1 Present Demand
0x0EE9	3818	R	R	2	Float32	A	Current I1 Peak Demand
0x0EEB	3820	R	R	4	DATETIME	—	Current I1 Peak Demand Date/Time
0x0EF5	3830	R	R	2	Float32	A	Current I2 Present Demand
0x0EF9	3834	R	R	2	Float32	A	Current I2 Peak Demand
0x0EFB	3836	R	R	4	DATETIME	—	Current I2 Peak Demand Date/Time
0x0F05	3846	R	R	2	Float32	A	Current I3 Present Demand
0x0F09	3850	R	R	2	Float32	A	Current I3 Peak Demand

Address	Register	Action (R/W/WC)		Size	Type	Units	Description
		PM3250	PM3255				
0x0F0B	3852	R	R	4	DATE TIME	—	Current I3 Peak Demand Date/Time
0x0F15	3862	R	R	2	Float32	A	Current In Present Demand
0x0F19	3866	R	R	2	Float32	A	Current In Peak Demand
0x0F1B	3868	R	R	4	DATE TIME	—	Current In Peak Demand Date/Time
0x0F25	3878	R	R	2	Float32	A	Current Avg Present Demand
0x0F29	3882	R	R	2	Float32	A	Current Avg Peak Demand
0x0F2B	3884	R	R	4	DATE TIME	—	Current Avg Peak Demand Date/Time

## MinMax Reset

Address	Register	Action (R/W/WC)		Size	Type	Units	Description
		PM3250	PM3255				
0x6A4D	27214	R	R	4	DATE TIME	—	Minimum/Maximum Reset Date/Time

## Minimum Values

Address	Register	Action (R/W/WC)		Size	Type	Units	Description
		PM3250	PM3255				
<b>Current</b>							
0x6A51	27218	R	R	2	Float32	A	Minimum Current I1
0x6A53	27220	R	R	2	Float32	A	Minimum Current I2
0x6A55	27222	R	R	2	Float32	A	Minimum Current I3
0x6A57	27224	R	R	2	Float32	A	Minimum Current N
0x6A5B	27228	R	R	2	Float32	A	Minimum Current Avg
<b>Voltage</b>							
0x6A65	27238	R	R	2	Float32	V	Minimum Voltage L1-L2
0x6A67	27240	R	R	2	Float32	V	Minimum Voltage L2-L3
0x6A69	27242	R	R	2	Float32	V	Minimum Voltage L3-L1
0x6A6B	27244	R	R	2	Float32	V	Minimum Voltage L-L Avg
0x6A6D	27246	R	R	2	Float32	V	Minimum Voltage L1-N
0x6A6F	27248	R	R	2	Float32	V	Minimum Voltage L2-N
0x6A71	27250	R	R	2	Float32	V	Minimum Voltage L3-N
0x6A75	27254	R	R	2	Float32	V	Minimum Voltage L-N Avg
<b>Power</b>							
0x6A87	27272	R	R	2	Float32	kW	Minimum Active Power Phase 1
0x6A89	27274	R	R	2	Float32	kW	Minimum Active Power Phase 2
0x6A8B	27276	R	R	2	Float32	kW	Minimum Active Power Phase 3
0x6A8D	27278	R	R	2	Float32	kW	Minimum Active Power Total
0x6A8F	27280	R	R	2	Float32	kVAR	Minimum Reactive Power Phase 1
0x6A91	27282	R	R	2	Float32	kVAR	Minimum Reactive Power Phase 2
0x6A93	27284	R	R	2	Float32	kVAR	Minimum Reactive Power Phase 3

Address	Register	Action (R/W/WC)		Size	Type	Units	Description
		PM3250	PM3255				
0x6A95	27286	R	R	2	Float32	kVAR	Minimum Reactive Power Total
0x6A97	27288	R	R	2	Float32	kVA	Minimum Apparent Power Phase 1
0x6A99	27290	R	R	2	Float32	kVA	Minimum Apparent Power Phase 2
0x6A9B	27292	R	R	2	Float32	kVA	Minimum Apparent Power Phase 3
0x6A9D	27294	R	R	2	Float32	kVA	Minimum Apparent Power Total
<b>Power Factor</b>							
0x6AA9	27306	R	R	2	4Q FP PF	—	Minimum Power Factor Phase 1
0x6AAB	27308	R	R	2	4Q FP PF	—	Minimum Power Factor Phase 2
0x6AAD	27310	R	R	2	4Q FP PF	—	Minimum Power Factor Phase 3
0x6AAF	27312	R	R	2	4Q FP PF	—	Minimum Power Factor Total
<b>Tangent Phi (Reactive Factor)</b>							
0x6AC7	27336	R	R	2	Float32	—	Minimum Tangent Phi, Total
<b>Total Harmonic Distortion, Current</b>							
0x6AC9	27338	R	R	2	Float32	%	Minimum THD Current I1
0x6ACB	27340	R	R	2	Float32	%	Minimum THD Current I2
0x6ACD	27342	R	R	2	Float32	%	Minimum THD Current I3
0x6ACF	27344	R	R	2	Float32	%	Minimum THD Current N
<b>Total Harmonic Distortion, Voltage</b>							
0x6ADF	27360	R	R	2	Float32	%	Minimum THD Voltage L1-L2
0x6AE1	27362	R	R	2	Float32	%	Minimum THD Voltage L2-L3
0x6AE3	27364	R	R	2	Float32	%	Minimum THD Voltage L3-L1
0x6AE5	27366	R	R	2	Float32	%	Minimum THD Voltage L-L Avg
0x6AE7	27368	R	R	2	Float32	%	Minimum THD Voltage L1-N
0x6AE9	27370	R	R	2	Float32	%	Minimum THD Voltage L2-N
0x6AEB	27372	R	R	2	Float32	%	Minimum THD Voltage L3-N
0x6AEF	27376	R	R	2	Float32	%	Minimum THD Voltage L-N Avg
<b>Frequency</b>							
0x6BDF	27616	R	R	2	Float32	Hz	Minimum Frequency

## Maximum Values

Address	Register	Action (R/W/WC)		Size	Type	Units	Description
		PM3250	PM3255				
<b>Current</b>							
0x6C2D	27694	R	R	2	Float32	A	Maximum Current I1
0x6C2F	27696	R	R	2	Float32	A	Maximum Current I2
0x6C31	27698	R	R	2	Float32	A	Maximum Current I3
0x6C33	27700	R	R	2	Float32	A	Maximum Current N
0x6C37	27704	R	R	2	Float32	A	Maximum Current Avg
<b>Voltage</b>							
0x6C41	27714	R	R	2	Float32	V	Maximum Voltage L1-L2

Address	Register	Action (R/W/WC)		Size	Type	Units	Description
		PM3250	PM3255				
0x6C43	27716	R	R	2	Float32	V	Maximum Voltage L2-L3
0x6C45	27718	R	R	2	Float32	V	Maximum Voltage L3-L1
0x6C47	27720	R	R	2	Float32	V	Maximum Voltage L-L Avg
0x6C49	27722	R	R	2	Float32	V	Maximum Voltage L1-N
0x6C4B	27724	R	R	2	Float32	V	Maximum Voltage L2-N
0x6C4D	27726	R	R	2	Float32	V	Maximum Voltage L3-N
0x6C51	27730	R	R	2	Float32	V	Maximum Voltage L-N Avg
<b>Power</b>							
0x6C63	27748	R	R	2	Float32	kW	Maximum Active Power Phase 1
0x6C65	27750	R	R	2	Float32	kW	Maximum Active Power Phase 2
0x6C67	27752	R	R	2	Float32	kW	Maximum Active Power Phase 3
0x6C69	27754	R	R	2	Float32	kW	Maximum Active Power Total
0x6C6B	27756	R	R	2	Float32	kVAR	Maximum Reactive Power Phase 1
0x6C6D	27758	R	R	2	Float32	kVAR	Maximum Reactive Power Phase 2
0x6C6F	27760	R	R	2	Float32	kVAR	Maximum Reactive Power Phase 3
0x6C71	27762	R	R	2	Float32	kVAR	Maximum Reactive Power Total
0x6C73	27764	R	R	2	Float32	kVA	Maximum Apparent Power Phase 1
0x6C75	27766	R	R	2	Float32	kVA	Maximum Apparent Power Phase 2
0x6C77	27768	R	R	2	Float32	kVA	Maximum Apparent Power Phase 3
0x6C79	27770	R	R	2	Float32	kVA	Maximum Apparent Power Total
<b>Power Factor</b>							
0x6C85	27782	R	R	2	4Q FP PF	—	Maximum Power Factor Phase 1
0x6C87	27784	R	R	2	4Q FP PF	—	Maximum Power Factor Phase 2
0x6C89	27786	R	R	2	4Q FP PF	—	Maximum Power Factor Phase 3
0x6C8B	27788	R	R	2	4Q FP PF	—	Maximum Power Factor Total
<b>Tangent Phi (Reactive Factor)</b>							
0x6CA3	27812	R	R	2	Float32	—	Maximum Tangent Phi, Total
<b>Total Harmonic Distortion, Current</b>							
0x6CA5	27814	R	R	2	Float32	%	Maximum THD Current I1
0x6CA7	27816	R	R	2	Float32	%	Maximum THD Current I2
0x6CA9	27818	R	R	2	Float32	%	Maximum THD Current I3
0x6CAB	27820	R	R	2	Float32	%	Maximum THD Current N
<b>Total Harmonic Distortion, Voltage</b>							
0x6CBB	27836	R	R	2	Float32	%	Maximum THD Voltage L1-L2
0x6CBD	27838	R	R	2	Float32	%	Maximum THD Voltage L2-L3
0x6CBF	27840	R	R	2	Float32	%	Maximum THD Voltage L3-L1
0x6CC1	27842	R	R	2	Float32	%	Maximum THD Voltage L-L Avg
0x6CC3	27844	R	R	2	Float32	%	Maximum THD Voltage L1-N
0x6CC5	27846	R	R	2	Float32	%	Maximum THD Voltage L2-N
0x6CC7	27848	R	R	2	Float32	%	Maximum THD Voltage L3-N
0x6CCB	27852	R	R	2	Float32	%	Maximum THD Voltage L-N Avg

Address	Register	Action (R/W/WC)		Size	Type	Units	Description
		PM3250	PM3255				
<b>Frequency</b>							
0x6DBB	28092	R	R	2	Float32	Hz	Maximum Frequency

## MinMax with Time Stamp

Address	Register	Action (R/W/WC)		Size	Type	Units	Description
		PM3250	PM3255				
0xB049	45130	R	R	4	DATE TIME	—	Minimum Current of I1, I2, I3 - Date/Time
0xB04D	45134	R	R	2	Float32	A	Minimum Current of I1, I2, I3 - Value
0xB04F	45136	R	R	4	DATE TIME	—	Minimum Power Factor Total - Date/Time
0xB053	45140	R	R	2	Float32	—	Minimum Power Factor Total - Value
0xB055	45142	R	R	4	DATE TIME	—	Maximum Current of I1, I2, I3 - Date/Time
0xB059	45146	R	R	2	Float32	A	Maximum Current of I1, I2, I3 - Value
0xB05B	45148	R	R	4	DATE TIME	—	Maximum Active Power Total - Date/Time
0xB05F	45152	R	R	2	Float32	kW	Maximum Active Power Total - Value
0xB061	45154	R	R	4	DATE TIME	—	Maximum Apparent Power Total - Date/Time
0xB065	45158	R	R	2	Float32	kVA	Maximum Apparent Power Total - Value
0xB067	45160	R	R	4	DATE TIME	—	Maximum Power Factor Total - Date/Time
0xB06B	45164	R	R	2	Float32	—	Maximum Power Factor Total - Value

## Power Quality

Address	Register	Action (R/W/WC)		Size	Type	Units	Description
		PM3250	PM3255				
0xB02B	45100	R	R	2	Float32	%	THD Current I1
0xB02D	45102	R	R	2	Float32	%	THD Current I2
0xB02F	45104	R	R	2	Float32	%	THD Current I3
0xB031	45106	R	R	2	Float32	%	THD Current Neutral
0xB033	45108	R	R	2	Float32	%	THD Phase Current Worst
0xB035	45110	R	R	2	Float32	%	THD Voltage L1-L2
0xB037	45112	R	R	2	Float32	%	THD Voltage L2-L3
0xB039	45114	R	R	2	Float32	%	THD Voltage L3-L1
0xB03B	45116	R	R	2	Float32	%	THD Voltage L-L Avg
0xB03D	45118	R	R	2	Float32	%	THD Voltage L-L Worst
0xB03F	45120	R	R	2	Float32	%	THD Voltage L1-N
0xB041	45122	R	R	2	Float32	%	THD Voltage L2-N
0xB043	45124	R	R	2	Float32	%	THD Voltage L3-N
0xB045	45126	R	R	2	Float32	%	THD Voltage L-N Avg
0xB047	45128	R	R	2	Float32	%	THD Voltage L-N Worst

## Alarms

Address	Register	Action (R/W/WC)		Size	Type	Units	Description
		PM3250	PM3255				
<b>Alarm Status</b>							
<b>Activated Alarm Bitmaps</b>							
0x2B0C	11021	R	R	1	Bitmap	—	0 = Alarm is inactive 1 = Alarm is active BitN = Alarm ID N (1-16)
0x2B0D	11022	R	R	1	Bitmap	—	BitN = Alarm ID N (17-32)
0x2B0E	11023	R	R	1	Bitmap	—	BitN = Alarm ID N (33-40) BitN fixed to 0
0x2B0F	11024	R	R	1	Bitmap	—	BitN = Alarm ID N (41-56) BitN fixed to 0 for PM3250
<b>Enabled Alarm Bitmaps</b>							
0x2B1F	11040	R	R	1	Bitmap	—	0 = Alarm is disabled 1 = Alarm is enabled BitN = Alarm ID N (1-16)
0x2B20	11041	R	R	1	Bitmap	—	BitN = Alarm ID N (17-32)
0x2B21	11042	R	R	1	Bitmap	—	BitN = Alarm ID N (33-40) BitN fixed to 0
0x2B22	11043	R	R	1	Bitmap	—	BitN = Alarm ID N (41-56) BitN fixed to 0 for PM3250
<b>Unacknowledged Alarm Bitmaps</b>							
0x2B45	11078	R	R	1	Bitmap	—	0 = Historic alarms are acknowledged by the user 1 = Historic alarms are unacknowledged by the user BitN = Alarm ID N (1-16)
0x2B46	11079	R	R	1	Bitmap	—	BitN = Alarm ID N (17-32)
0x2B47	11080	R	R	1	Bitmap	—	BitN = Alarm ID N (33-40) BitN fixed to 0
0x2B48	11081	R	R	1	Bitmap	—	BitN = Alarm ID N (41-56) BitN fixed to 0 for PM3250
<b>Alarm Event Queue</b>							
0x2B68	11113	R	R	1	UInt16	—	Size of Event Queue: Fixed as 20
0x2B69	11114	R	R	1	UInt16	—	Number of entries in Event Queue
0x2B6A	11115	R	R	1	UInt16	—	Entry number of Most Recent Event
<b>Entry 001</b>							
0x2B6B	11116	R	R	1	UInt16	—	Entry Number
0x2B6C	11117	R	R	4	DATETIME	—	Date/Time
0x2B70	11121	R	R	1	UInt16	—	Record Type: 0xFF10 = UInt16 0xFF40 = Float32
0x2B71	11122	R	R	1	UInt16	—	Register Number or Event Code: Primary Event: Modbus Address of the Unit Secondary Event: Event Code

Address	Register	Action (R/W/WC)		Size	Type	Units	Description
		PM3250	PM3255				
0x2B72	11123	R	R	4	UInt16	—	Value: Primary Event: Alarm Attributes Register Address Secondary Event: Worst value of source registers
0x2B76	11127	R	R	1	UInt16	—	Sequence Number
<b>Entry 020</b>							
0x2C4F	11344	R	R	1	UInt16	—	Entry Number
0x2C50	11345	R	R	4	DATETIME	—	Date/Time
0x2C54	11349	R	R	1	UInt16	—	Record Type
0x2C55	11350	R	R	1	UInt16	—	Register Number or Event Code
0x2C56	11351	R	R	4	UInt16	—	Value
0x2C5A	11355	R	R	1	UInt16	—	Sequence Number
<b>Alarm History Log</b>							
0x301B	12316	R	R	1	UInt16	—	Size of History Log
0x301C	12317	R	R	1	UInt16	—	Number of entries in History Log
0x301D	12318	R	R	1	UInt16	—	Entry number of most Recent Event
<b>Entry 001</b>							
0x301E	12319	R	R	1	UInt16	—	Entry Number
0x301F	12320	R	R	4	DATETIME	—	Date/Time
0x3023	12324	R	R	1	UInt16	—	Record Type: 0xFF10 = UInt16 0xFF40 = Float32
0x3024	12325	R	R	1	UInt16	—	Register Number or Event Code: Primary Event: Modbus Address of the Unit Secondary Event: Event Code
0x3025	12326	R	R	4	UInt16	—	Value: Primary Event: Alarm Attributes Register Address Secondary Event: Worst value of source registers
0x3029	12330	R	R	1	UInt16	—	Sequence Number
<b>Entry 020</b>							
0x3102	12547	R	R	1	UInt16	—	Entry Number
0x3103	12548	R	R	4	DATETIME	—	Date/Time
0x3107	12552	R	R	1	UInt16	—	Record Type
0x3108	12553	R	R	1	UInt16	—	Register Number or Event Code
0x3109	12554	R	R	4	UInt16	—	Value
0x310D	12558	R	R	1	UInt16	—	Sequence Number
<b>1- Second Alarms - Standard</b>							
<b>Over Current, Phase</b>						<b>Alarm ID = 1</b>	
0x36B4	14005	R/WC	R/WC	2	Float32	A	Pickup Setpoint
0x36B6	14007	R/WC	R/WC	2	UInt32	Second	Pickup Time Delay
0x36B8	14009	R/WC	R/WC	2	Float32	%	Dropout Setpoint Deviation percentage from pickup setpoint
0x36BA	14011	R/WC	R/WC	2	UInt32	Second	Dropout Time Delay Same as pickup time delay

Address	Register	Action (R/W/WC)		Size	Type	Units	Description
		PM3250	PM3255				
0x36BC	14013	R/WC	R/WC	1	Bitmap	—	Digital Outputs to Associate: 0 = Unassociated 1 = Associated Bit0 = DO1 association Bit1 = DO2 association
<b>Under Current, Phase</b>							<b>Alarm ID = 2</b>
0x36C8	14025	—	R/WC	2	Float32	A	Pickup Setpoint
0x36CA	14027	—	R/WC	2	UInt32	Second	Pickup Time Delay
0x36CC	14029	—	R/WC	2	Float32	%	Dropout Setpoint
0x36CE	14031	—	R/WC	2	UInt32	Second	Dropout Time Delay
0x36D0	14033	—	R/WC	1	Bitmap	—	Digital Outputs to Associate
<b>Over Voltage, L-L</b>							<b>Alarm ID = 5</b>
0x3704	14085	—	R/WC	2	Float32	V	Pickup Setpoint
0x3706	14087	—	R/WC	2	UInt32	Second	Pickup Time Delay
0x3708	14089	—	R/WC	2	Float32	%	Dropout Setpoint
0x370A	14091	—	R/WC	2	UInt32	Second	Dropout Time Delay
0x370C	14093	—	R/WC	1	Bitmap	—	Digital Outputs to Associate
<b>Under Voltage, L-L</b>							<b>Alarm ID = 6</b>
0x3718	14105	R/WC	R/WC	2	Float32	V	Pickup Setpoint
0x371A	14107	R/WC	R/WC	2	UInt32	Second	Pickup Time Delay
0x371C	14109	R/WC	R/WC	2	Float32	%	Dropout Setpoint
0x371E	14111	R/WC	R/WC	2	UInt32	Second	Dropout Time Delay
0x3720	14113	R/WC	R/WC	1	Bitmap	—	Digital Outputs to Associate
<b>Over Voltage, L-N</b>							<b>Alarm ID = 7</b>
0x372C	14125	—	R/WC	2	Float32	V	Pickup Setpoint
0x372E	14127	—	R/WC	2	UInt32	Second	Pickup Time Delay
0x3730	14129	—	R/WC	2	Float32	%	Dropout Setpoint
0x3732	14131	—	R/WC	2	UInt32	Second	Dropout Time Delay
0x3734	14133	—	R/WC	1	Bitmap	—	Digital Outputs to Associate
<b>Under Voltage, L-N</b>							<b>Alarm ID = 8</b>
0x3740	14145	R/WC	R/WC	2	Float32	V	Pickup Setpoint
0x3742	14147	R/WC	R/WC	2	UInt32	Second	Pickup Time Delay
0x3744	14149	R/WC	R/WC	2	Float32	%	Dropout Setpoint
0x3746	14151	R/WC	R/WC	2	UInt32	Second	Dropout Time Delay
0x3748	14153	R/WC	R/WC	1	Bitmap	—	Digital Outputs to Associate
<b>Over Power, Total Active</b>							<b>Alarm ID = 9</b>
0x3754	14165	R/WC	R/WC	2	Float32	kW	Pickup Setpoint
0x3756	14167	R/WC	R/WC	2	UInt32	Second	Pickup Time Delay
0x3758	14169	R/WC	R/WC	2	Float32	%	Dropout Setpoint
0x375A	14171	R/WC	R/WC	2	UInt32	Second	Dropout Time Delay
0x375C	14173	R/WC	R/WC	1	Bitmap	—	Digital Outputs to Associate
<b>Over Power, Total Reactive</b>							<b>Alarm ID = 10</b>



Address	Register	Action (R/W/WC)		Size	Type	Units	Description
		PM3250	PM3255				
0x3768	14185	—	R/WC	2	Float32	kVAR	Pickup Setpoint
0x376A	14187	—	R/WC	2	UInt32	Second	Pickup Time Delay
0x376C	14189	—	R/WC	2	Float32	%	Dropout Setpoint
0x376E	14191	—	R/WC	2	UInt32	Second	Dropout Time Delay
0x3770	14193	—	R/WC	1	Bitmap	—	Digital Outputs to Associate
<b>Over Power, Total Active</b>							<b>Alarm ID = 11</b>
0x377C	14205	R/WC	R/WC	2	Float32	kVA	Pickup Setpoint
0x377E	14207	R/WC	R/WC	2	UInt32	Second	Pickup Time Delay
0x3780	14209	R/WC	R/WC	2	Float32	%	Dropout Setpoint
0x3782	14211	R/WC	R/WC	2	UInt32	Second	Dropout Time Delay
0x3784	14213	R/WC	R/WC	1	Bitmap	—	Digital Outputs to Associate
<b>Leading Power Factor, Total</b>							<b>Alarm ID = 12</b>
0x3790	14225	—	R/WC	2	Float32	—	Pickup Setpoint
0x3792	14227	—	R/WC	2	UInt32	Second	Pickup Time Delay
0x3794	14229	—	R/WC	2	Float32	%	Dropout Setpoint
0x3796	14231	—	R/WC	2	UInt32	Second	Dropout Time Delay
0x3798	14233	—	R/WC	1	Bitmap	—	Digital Outputs to Associate
<b>Lagging Power Factor, Total</b>							<b>Alarm ID = 13</b>
0x37A4	14245	—	R/WC	2	Float32	—	Pickup Setpoint
0x37A6	14247	—	R/WC	2	UInt32	Second	Pickup Time Delay
0x37A8	14249	—	R/WC	2	Float32	%	Dropout Setpoint
0x37AA	14251	—	R/WC	2	UInt32	Second	Dropout Time Delay
0x37AC	14253	—	R/WC	1	Bitmap	—	Digital Outputs to Associate
<b>Over Demand, Total Active Power, Present</b>							<b>Alarm ID = 16</b>
0x37E0	14305	—	R/WC	2	Float32	kW	Pickup Setpoint
0x37E2	14307	—	R/WC	2	UInt32	Second	Pickup Time Delay
0x37E4	14309	—	R/WC	2	Float32	%	Dropout Setpoint
0x37E6	14311	—	R/WC	2	UInt32	Second	Dropout Time Delay
0x37E8	14313	—	R/WC	1	Bitmap	—	Digital Outputs to Associate
<b>Over Demand, Total Apparent Power, Present</b>							<b>Alarm ID = 22</b>
0x3858	14425	—	R/WC	2	Float32	kVA	Pickup Setpoint
0x385A	14427	—	R/WC	2	UInt32	Second	Pickup Time Delay
0x385C	14429	—	R/WC	2	Float32	%	Dropout Setpoint
0x385E	14431	—	R/WC	2	UInt32	Second	Dropout Time Delay
0x3860	14433	—	R/WC	1	Bitmap	—	Digital Outputs to Associate
<b>Over THD-U, Phase</b>							<b>Alarm ID = 28</b>
0x38D0	14545	—	R/WC	2	Float32	%	Pickup Setpoint
0x38D2	14547	—	R/WC	2	UInt32	Second	Pickup Time Delay
0x38D4	14549	—	R/WC	2	Float32	%	Dropout Setpoint
0x38D6	14551	—	R/WC	2	UInt32	Second	Dropout Time Delay
0x38D8	14553	—	R/WC	1	Bitmap	—	Digital Outputs to Associate

Address	Register	Action (R/W/WC)		Size	Type	Units	Description
		PM3250	PM3255				
<b>Under Power, Total Active</b>							<b>Alarm ID = 30</b>
0x39E8	14825	R/WC	R/WC	2	Float32	kW	Pickup Setpoint
0x39EA	14827	R/WC	R/WC	2	UInt32	Second	Pickup Time Delay
0x39EC	14829	R/WC	R/WC	2	Float32	%	Dropout Setpoint
0x39EE	14831	R/WC	R/WC	2	UInt32	Second	Dropout Time Delay
0x39F0	14833	R/WC	R/WC	1	Bitmap	—	Digital Outputs to Associate
<b>Over THD-I, Phase</b>							<b>Alarm ID = 31</b>
0x3A10	14865	—	—	2	Float32	%	Pickup Setpoint
0x3A12	14867	—	R/WC	2	UInt32	Second	Pickup Time Delay
0x3A14	14869	—	R/WC	2	Float32	%	Dropout Setpoint
0x3A16	14871	—	R/WC	2	UInt32	Second	Dropout Time Delay
0x3A18	14873	—	R/WC	1	Bitmap	—	Digital Outputs to Associate
<b>Over THD-V, Phase</b>							<b>Alarm ID = 32</b>
0x3A38	14905	—	R/WC	2	Float32	%	Pickup Setpoint
0x3A3A	14907	—	R/WC	2	UInt32	Second	Pickup Time Delay
0x3A3C	14909	—	R/WC	2	Float32	%	Dropout Setpoint
0x3A3E	14911	—	R/WC	2	UInt32	Second	Dropout Time Delay
0x3A40	14913	—	R/WC	1	Bitmap	—	Digital Outputs to Associate
<b>1-Second Alarms - Custom</b>							
<b>Over Energy, Total Active</b>							<b>Alarm ID = 41</b>
0x3A5D	14942	—	R/WC	2	UInt16	—	Source Register: ENERGY_LOG_DAY_REALTIME_VALUE: 41504 ENERGY_LOG_WEEK_REALTIME_VALUE: 41874 ENERGY_LOG_MONTH_REALTIME_VALUE: 42043
0x3A60	14945	—	R/WC	2	Float32	Wh	Pickup Setpoint
0x3A62	14947	—	R/WC	2	UInt32	Second	Pickup Time Delay
0x3A64	14949	—	R/WC	2	Float32	%	Dropout Setpoint
0x3A66	14951	—	R/WC	2	UInt32	Second	Dropout Time Delay
0x3A68	14953	—	R/WC	1	Bitmap	—	Digital Outputs to Associate

## Energy Log

Address	Register	Action (R/W/WC)		Size	Type	Units	Description
		PM3250	PM3255				
<b>Energy Log - Day</b>							
0xB21F	45600	—	R	1	UInt16	—	Enable/Disable: 0x0000 = Disable 0xFFFF = Enable
0xB220	45601	—	R	1	UInt16	—	Maximum Entry Number
0xB221	45602	—	R	1	UInt16	—	Current Entry Number

Address	Register	Action (R/W/WC)		Size	Type	Units	Description
		PM3250	PM3255				
0xB222	45603	—	R	1	UInt16	—	Latest Entry ID
0xB223	45604	—	R	1	UInt16	—	Oldest Entry ID
0xB224	45605	—	R	4	Int64	Wh	Real-time Value of Current Day
0xB228	45609	—	R	4	DATE TIME	—	Entry 001 Date/Time
0xB22C	45613	—	R	4	Int64	Wh	Entry 001 Value
0xB388	45961	—	R	4	DATE TIME	—	Entry 045 Date/Time
0xB38C	45965	—	R	4	Int64	Wh	Entry 045 Value
<b>Energy Log - Week</b>							
0xB390	45969	—	R	1	UInt16	—	Enable/Disable: 0x0000 = Disable 0xFFFF = Enable
0xB391	45970	—	R	1	UInt16	—	Maximum Entry Number
0xB392	45971	—	R	1	UInt16	—	Current Entry Number
0xB393	45972	—	R	1	UInt16	—	Latest Entry ID
0xB394	45973	—	R	1	UInt16	—	Oldest Entry ID
0xB395	45974	—	R	4	Int64	Wh	Real-time Value of Current Day
0xB399	45978	—	R	4	DATE TIME	—	Entry 001 Date/Time
0xB39D	45982	—	R	4	Int64	Wh	Entry 001 Value
0xB431	46130	—	R	4	DATE TIME	—	Entry 020 Date/Time
0xB435	46134	—	R	4	Int64	Wh	Entry 020 Value
<b>Energy Log - Month</b>							
0xB439	46138	—	R	1	UInt16	—	Enable/Disable: 0x0000 = Disable 0xFFFF = Enable
0xB43A	46139	—	R	1	UInt16	—	Maximum Entry Number
0xB43B	46140	—	R	1	UInt16	—	Current Entry Number
0xB43C	46141	—	R	1	UInt16	—	Latest Entry ID
0xB43D	46142	—	R	1	UInt16	—	Oldest Entry ID
0xB43E	46143	—	R	4	Int64	Wh	Real-time Value of Current Day
0xB442	46147	—	R	4	DATE TIME	—	Entry 001 Date/Time
0xB446	46151	—	R	4	Int64	Wh	Entry 001 Value
0xB4A2	46243	—	R	4	DATE TIME	—	Entry 013 Date/Time
0xB4A6	46247	—	R	4	Int64	Wh	Entry 013 Value

## Flex log record information

Address	Register	Action (R/W/WC)		Size	Type	Units	Description
		PM3250	PM3255				
0xB15A	45403	—	R	1	UInt16	—	Allocated File size (max # of records in file) Peak Demand Log = 27648 Energy + Energy Log = 18688
0xB15B	45404	—	R	1	UInt16	—	Allocated Record size (record length in registers) Peak Demand Log = 6 Other Log = 8
0xB15E	45407	—	R	1	UInt16	—	Current Number of Records Contained in the File Peak Demand Log = 0 – 27647 Energy + Energy Log = 0 – 18687
0xB15F	45408	—	R	1	UInt16	—	First Record Sequence Number Peak Demand Log = 0 – 27647 Energy + Energy = 0 – 18687
0xB160	45409	—	R	4	UInt16	—	Last Record Sequence Number Peak Demand Log = 0 – 27647 Energy + Energy = 0 – 18687

## Flex log configuration information

Address	Register	Action (R/W/WC)		Size	Type	Units	Description
		PM3250	PM3255				
0xB1BB	45500	—	R	1	UInt16	—	Flex log mode: 0 = Disable 1 = Peak Demand 2 = KWH_KVAH 3 = KWH_KVARH 4 = KVARH_KVAH 5 = KWH_KW 6 = KWH_KVA
0xB1BC	45501	—	R	1	UInt16	—	Flex log interval duration in minutes: 10, 15, 20, 30, 60

## Read Device Identification

The meter supports the Read Device Identification with the mandatory objects:

- Vendor Name
- Product Code
- Revision Number

Object ID	Name / Description	Length	Value	Note
0x00	Vendor Name	16	Schneider Electric	—
0x01	Product Code	11	METSEPM3200 METSEPM3210 METSEPM3250 METSEPM3255	The Product Code value is identical to the catalog number of each reference
0x02	Major Minor Revision	04	X.Y.ZTT	Equivalent to X.Y in register 1637

The Read Device ID codes 01 and 04 are supported:

- 01 = request to get basic device identification (stream access)
- 04 = request to get one specific identification object (individual access)

The Modbus request and response are compliant with the Modbus Application Protocol Specification.

# Power, energy and power factor

## Power (PQS)

A typical AC electrical system load has both resistive and reactive (inductive or capacitive) components. Resistive loads consume real power (P) and reactive loads consume reactive power (Q).

Apparent power (S) is the vector sum of real power (P) and reactive power (Q):

$$S = \sqrt{P^2 + Q^2}$$

Real power is measured in watt (W or kW), reactive power is measured in var (VAR or kVAR) and apparent power is measured in volt-amp (VA or kVA).

## Power and the PQ coordinate system

The meter uses the values of real power (P) and reactive power (Q) on the PQ coordinate system to calculate apparent power.

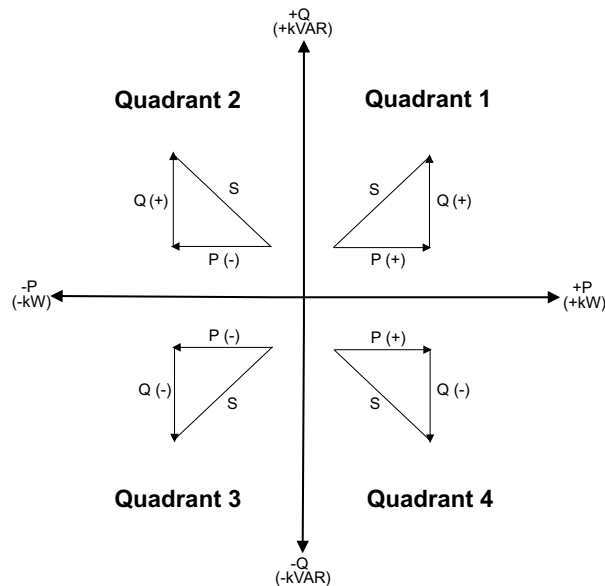

## Power flow

Positive power flow P(+) and Q(+) means power is flowing from the power source towards the load. Negative power flow P(-) and Q(-) means power is flowing from the load towards the power source.

## Energy delivered (imported) / energy received (exported)

The meter interprets energy delivered (imported) or received (exported) according to the direction of real power (P) flow.

Energy delivered (imported) means positive real power flow (+P) and energy received (exported) means negative real power flow (-P).

Quadrant	Real (P) power flow	Energy delivered (imported) or received (exported)
Quadrant 1	Positive (+)	Energy delivered (imported)
Quadrant 2	Negative (-)	Energy received (exported)
Quadrant 3	Negative (-)	Energy received (exported)
Quadrant 4	Positive (+)	Energy delivered (imported)

## Power factor (PF)

Power factor (PF) is the ratio of real power (P) to apparent power (S).

PF is provided as a number between -1 and 1 or as a percentage from -100% to 100%, where the sign is determined by the convention.

$$PF = \frac{P}{S}$$

A purely resistive load has no reactive components, so its power factor is 1 (PF = 1, or unity power factor). Inductive or capacitive loads introduce a reactive power (Q) component to the circuit which causes the PF to become closer to zero.

## True PF

True power factor includes harmonic content.

## PF lead / lag convention

The meter correlates leading power factor (PF lead) or lagging power factor (PF lag) with whether the current waveform is leading or lagging the voltage waveform.

## Current phase shift from voltage

For purely resistive loads the current waveform is in phase with the voltage waveform. For capacitive loads, current leads voltage. For inductive loads, current lags voltage.

## Current lead / lag and load type

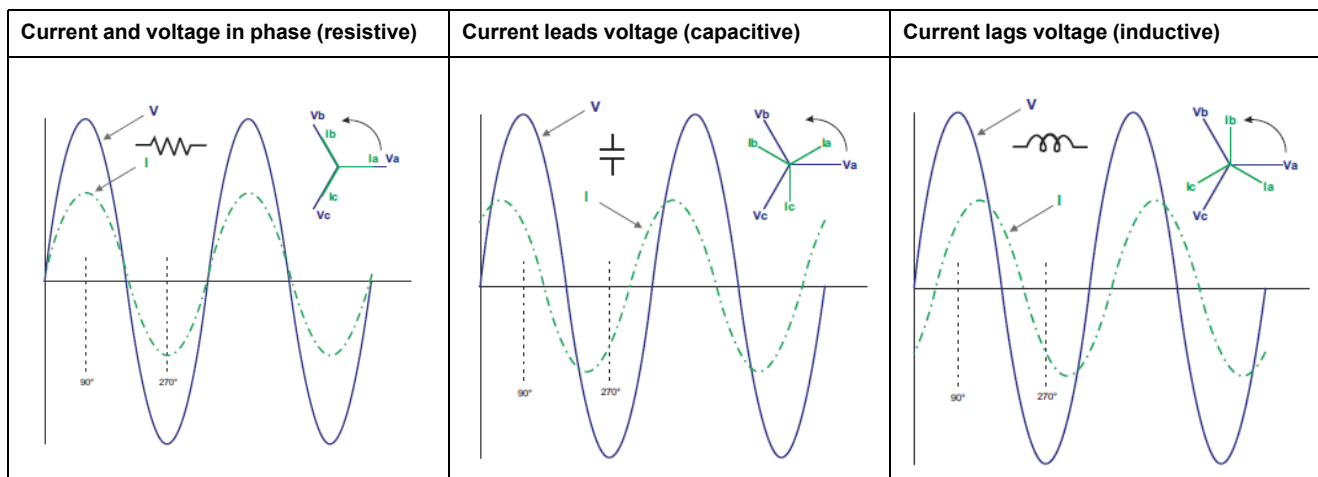

## Power and PF lead / lag

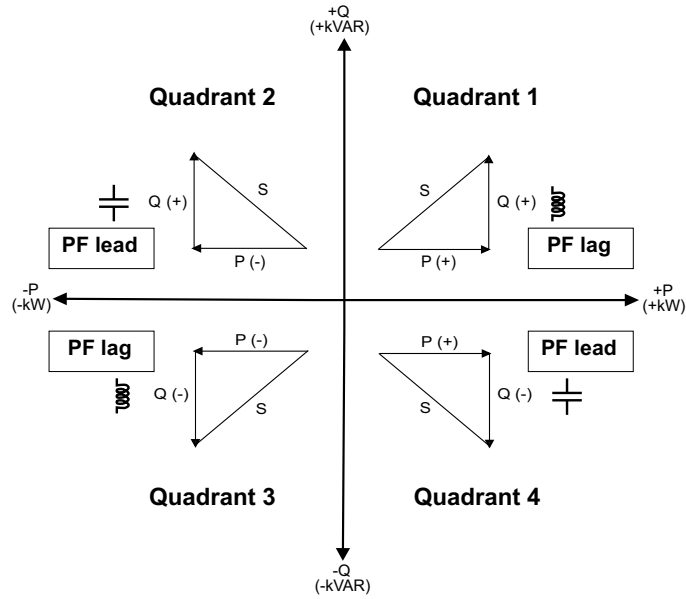

## PF lead / lag summary

**NOTE:** The lagging or leading distinction does **NOT** equate to a positive or negative value. Rather, lagging corresponds to an inductive load, while leading corresponds to a capacitive load.

Quadrant	Current phase shift	load type	
Quadrant 1	Current lags voltage	Inductive	PF lag
Quadrant 2	Current leads voltage	Capacitive	PF lead
Quadrant 3	Current lags voltage	Inductive	PF lag
Quadrant 4	Current leads voltage	Capacitive	PF lead

## PF sign convention

The meter shows positive or negative power factor according to IEC standards.

## PF sign in IEC

The meter correlates power factor sign (PF sign) with the direction of real power (P) flow.

- For positive real power (+P), the PF sign is positive (+).
- For negative real power (-P), the PF sign is negative (-).



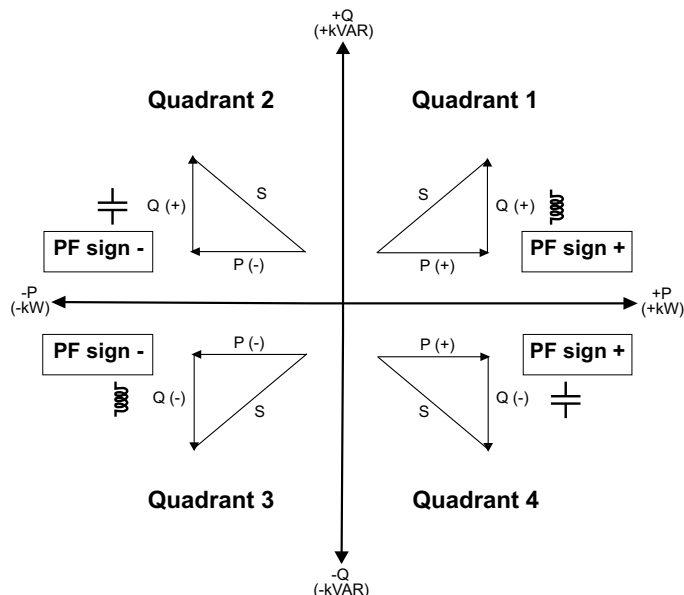

## Power factor register format

The meter performs a simple algorithm to the PF value then stores it in the PF register.

Each power factor value (PF value) occupies one floating point register for power factor (PF register). The meter and software interpret the PF register for all reporting or data entry fields according to the following diagram:

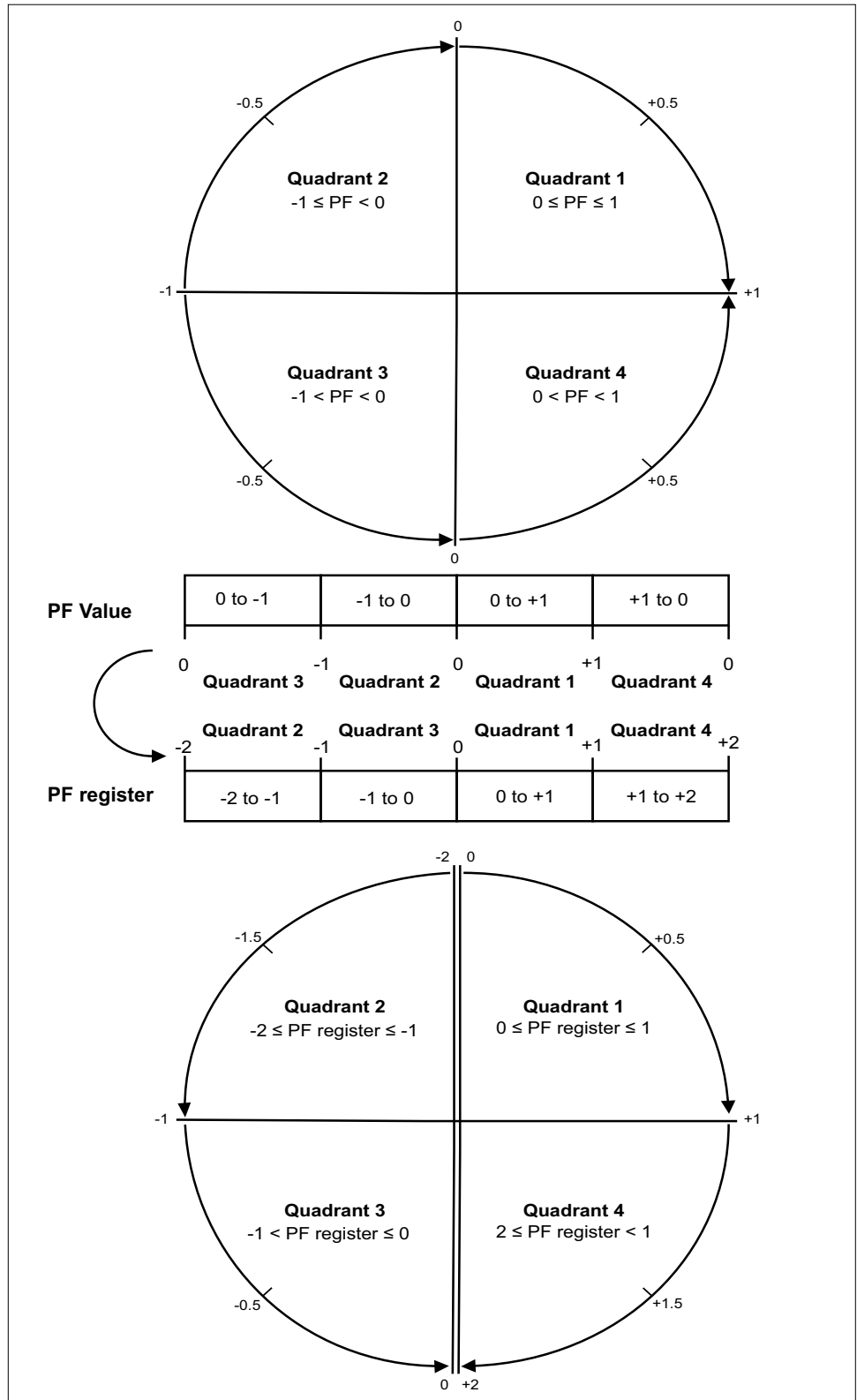

The PF value is calculated from the PF register value using the following formulae:

Quadrant	PF range	PF register range	PF formula
Quadrant 1	0 to +1	0 to +1	PF value = PF register value
Quadrant 2	-1 to 0	-2 to -1	PF value = (-2) - (PF register value)
Quadrant 3	0 to -1	-1 to 0	PF value = PF register value
Quadrant 4	+1 to 0	+1 to +2	PF value = (+2) - (PF register value)

# Maintenance and Troubleshooting

## Overview

The meter does not contain any user-serviceable parts. If the meter requires service, contact your local Schneider Electric representative.

### **NOTICE**

#### **RISK OF DAMAGE TO THE METER**

- Do not open the meter case.
- Do not attempt to repair any components of the meter.

**Failure to follow these instructions can result in equipment damage.**

Do not open the meter. Opening the meter voids the warranty.

## Password recovery

If you forget your password, contact Technical Support.

## Language Download

You can download new language files onto the meter over communications using DLF3000 software. Both DLF software and language pack firmware files are available as free downloads from [www.se.com](http://www.se.com).

## Enabling language download on the meter

You must use the meter display to enable the download of new language files before you download the files to your meter.

1. Navigate to **Setup > LanDL** and click **OK**.
2. Click **OK** to confirm.

## Diagnostic codes

If the combination of the backlight and the error / alert icon indicates an error or an abnormal situation, navigate to the diagnostics screen and find the diagnostics code. If the problem persists after following the instructions in the table, please contact Technical Support.

Diagnostic code	PM3200 PM3250	PM3210 PM3255	Description	Possible solution
—	√	√	LCD display is not visible.	Check and adjust LCD contrast/backlight settings.
—	√	√	Push buttons do not function.	Restart the meter by power off and power on again.
101, 102	√	√	Metering stops due to internal error.	Enter the Configuration mode and implement <b>Reset Config</b> .

Diagnostic code	PM3200 PM3250	PM3210 PM3255	Description	Possible solution
			Total energy consumption is displayed.	
201	√	√	Metering continues. Mismatch between frequency settings and frequency measurements.	Correct frequency settings according to the nominal frequency of the network.
202	√	√	Metering continues. Mismatch between wiring settings and wiring inputs.	Correct wiring settings according to wiring inputs.
203	√	√	Metering continues. Phase sequence reverses.	Check wire connections or correct wiring settings.
205	√	√	Metering continues. Date and time have been reset due to loss of power.	Set Date and time.
206	—	√	Metering continues. Pulse is missing due to overload on energy pulse output.	Check the energy pulse output settings and correct if needed.
207	√	√	Metering continues. Abnormal internal clock function.	Restart the meter by power off and power on again.

# Specifications

## Electrical characteristics

### Measurement accuracy

IEC 61557-12	x/5 A CTs: PMD/Sx/K55/0.5 x/1 A CTs: IEC 61557-12 PMD/Sx/K55/1
Current	x/5 A CTs: $\pm 0.3\%$ , 0.5 – 6 A x/1 A CTs: $\pm 0.5\%$ , 0.1 – 1.2 A
Voltage	$\pm 0.3\%$ , 50 – 330 V L-N or 80 – 570 V L-L
Power factor	x/5 A CTs: $\pm 0.005$ , 0.5 A – 6 A x/1A CTs: 0.1 – 1.2 A 0.5 L – 0.8 C
Active / Apparent power	x/5 A CTs: Class 0.5 x/1 A CTs: Class 1
Reactive power	Class 2
Frequency	45 – 65 Hz $\pm 0.05\%$
Active energy	x/5 A CTs: IEC 62053-22 Class 0.5S x/1 A CTs: IEC 62053-21 Class 1
Reactive energy	IEC 62053-23 Class 2

### Voltage inputs

Measured voltage	Wye: 60 – 277 V L-N, 100 – 480 V L-L $\pm 20\%$ Delta: 100 – 480 V L-L $\pm 20\%$
Overload	332 V L-N or 575 V L-L
Frequency	50 / 60 Hz $\pm 10\%$
Minimum wire temperature rating required	90 °C (194 °F)
Impedance	3 M $\Omega$
Burden	0.2 VA
Impulse voltage withstand	6 KV for 1.2 $\mu$ S waveform
Measurement category	III
Wire	2.5 mm <sup>2</sup> (14 AWG) (Recommended: Copper wire)
Wire strip length	8 mm (0.31 in)
Torque	0.5 N·m (4.4 in·lb)

### Current inputs

Nominal current	1 A or 5 A Requires x/5A or x/1A current transformers
Measured current	20 mA – 6 A
Withstand	10 A continuous, 20 A at 10 sec/hr
Impedance	< 1 m $\Omega$
Burden	< 0.036 VA at 6 A
Minimum wire temperature rating required	90 °C (194 °F)
Wire	6 mm <sup>2</sup> (10 AWG)

**Current inputs (Continued)**

	(Recommended: Copper wire)
Wire strip length	8 mm (0.31 in)
Torque	0.8 N·m (7 in·lb)

**Control power**

Operating range	AC: 100 – 277 V L-N, 173 – 480 V L-L ±20% DC: 100 – 300 V
Frequency	45 – 65 Hz
Burden	AC: 5 VA DC: 3 W
Wire	6 mm <sup>2</sup> (10 AWG) (Recommended: Copper wire)
Wire strip length	8 mm (0.31 in)
Torque	0.8 N·m (7 in·lb)
Installation category	III

**Digital output (PM3255)**

Number	2
Type	Solid-state relay
Load voltage	5 – 40 V DC
Maximum load current	50 mA
Output resistance	50 Ω maximum
Isolation	3.75 kV
Wire	1.5 mm <sup>2</sup> (16 AWG)
Wire strip length	6 mm (0.23 in)
Torque	0.5 N·m (4.4 in·lb)

**Pulse output (PM3210)**

Number	1
Type	Opto-coupler output for remote transfer IEC 62053-31 compatible (S0 format output)
Pulses / kWh	Configurable
Voltage	5 – 30 V DC
Current	1 – 15 mA
Pulse width	Configurable, 50 ms minimum
Isolation	3.75 kV
Wire	2.5 mm <sup>2</sup> (14 AWG)
Wire strip length	6 mm (0.23 in)
Torque	0.5 N·m (4.4 in·lb)

**Digital input (PM3255)**

Number	2
Type	Type 1 opto-coupler inputs

**Digital input (PM3255) (Continued)**

	IEC 61131-2 compatible
Maximum input	Voltage: 40 V DC Current: 4 mA
OFF state	0 – 5 V DC
ON state	11 – 40 V DC
Nominal voltage	24 V DC
Isolation	3.75 kV
Wire	1.5 mm <sup>2</sup> (16 AWG)
Wire strip length	6 mm (0.23 in)
Torque	0.5 N·m (4.4 in·lb)

**Mechanical characteristics**

Weight	0.26 kg (0.57 lb)	
IP degree of protection	Front panel	IP40
	Meter body	IP20
Display dimensions	43 x 34.6 mm (1.7 x 1.3 in)	
Display resolution	128 x 96	
Display data update rate	1 second	
Energy pulsing LED	5000 flashes / kWh without consideration of transformer ratios	

**Environmental characteristics**

Operating temperature	-25 to +70 °C (-13 to +158 °F)
Storage temperature	-40 to +85 °C (-40 to +185 °F)
Humidity rating	5 to 95% RH non-condensing at 50 °C (122 °F)
Pollution degree	2
Altitude	< 2000 m (6561 ft)
Location	Indoor use only

**EMC (electromagnetic compatibility)**

Electrostatic discharge	IEC 61000-4-2
Immunity to radiated fields	IEC 61000-4-3
Immunity to fast transients	IEC 61000-4-4
Immunity to surge	IEC 61000-4-5
Conducted immunity	IEC 61000-4-6
Immunity to power frequency magnetic fields	0.5 mT (IEC 61000-4-8)
Conducted and radiated emissions	Class B (EN 55022)

## Safety and standards

Safety	CE as per IEC 61010-1
Protective class	II Double insulated for user accessible parts
Standard compliance	IEC 61557-12, EN 61557-12 IEC 61010-1, UL61010-1 IEC 62052-11, IEC 62053-21, IEC 62053-22, IEC 62053-23

## Modbus RS-485 communications (PM3250 / PM3255)

Number of ports	1
Parity	Even, Odd, None
Baud rate	9600, 19200, 38400
Number of stop bits	1
Isolation	4 kV, double insulation
Wire	2.5 mm <sup>2</sup> (14 AWG)
Wire strip length	7 mm (0.28 in)
Torque	0.5 N·m (4.4 in·lb)

## Meter internal battery

The internal battery in the meter keeps the real-time clock (RTC) running when it is powered down to help maintain the meter time.

The life expectancy of the meter's internal battery is estimated to be over 10 years at 25 °C (77 °F) under typical operating conditions.

## Real-time clock

Type	Quartz crystal based
Clock drift	< 2.5 s/day (30 ppm)
Battery backup time	3 years without control power (typical)



# China Standard Compliance

This product complies with the following standard(s) in China:

IEC 61557-12:2007 Electrical safety in low voltage distribution systems up to 1 000 V a.c. and 1 500 V d.c. - Equipment for testing, measuring or monitoring of protective measures - Part 12: Performance measuring and monitoring devices

Schneider Electric  
35 rue Joseph Monier  
92500 Rueil Malmaison  
France

+ 33 (0) 1 41 29 70 00

[www.se.com](http://www.se.com)

As standards, specifications, and design change from time to time,  
please ask for confirmation of the information given in this publication.

© 2022 – Schneider Electric. All rights reserved.

DOCA0006EN-07