

Line Series

Canalis KB 25 and 40 A

Catalogue 04-2022

Prefabricated busbar trunking for lighting and power distribution



se.com

Life Is On

Schneider
Electric



Green Premium™

An industry leading portfolio of offers delivering sustainable value

More than 75% of our product sales offer superior transparency on the material content, regulatory information and environmental impact of our products:

- RoHS compliance
- REACH substance information
- Industry leading # of PEP's*
- Circularity instructions



Discover what we mean by green
[Check your products!](#)

The Green Premium program stands for our commitment to deliver customer valued sustainable performance. It has been upgraded with recognized environmental claims and extended to cover all offers including Products, Services and Solutions.

CO₂ and P&L impact through... Resource Performance

Green Premium brings improved resource efficiency throughout an asset's lifecycle. This includes efficient use of energy and natural resources, along with the minimization of CO₂ emissions.

Cost of ownership optimization through... Circular Performance

We're helping our customers optimize the total cost of ownership of their assets. To do this, we provide IoT-enabled solutions, as well as upgrade, repair, retrofit, and remanufacture services.

Peace of mind through... Well-being Performance

Green Premium products are RoHS and REACH compliant. We're going beyond regulatory compliance with step-by-step substitution of certain materials and substances from our products.

Improved sales through... Differentiation

Green Premium delivers strong value propositions through third-party labels and services. By collaborating with third-party organizations we can support our customers in meeting their sustainability goals such as green building certifications.

*PEP: Product Environmental Profile (i.e. Environmental Product Declaration)

Canalis KB 25 and 40 A

Presentation	4	A
Description	16	B
Catalogue numbers	23	C
Dimensions	40	D
Design guide	44	E
Applications	54	F
Index	64	G

Presentation

Canalis, a comprehensive and consistent busbar trunking system for...

A new path for achieving your electrical installations

Canalis is part of a comprehensive offer of products that are perfectly coordinated to meet all medium and low voltage electrical distribution requirements.

All of these products have been designed to work together: electrical, mechanical and communication compatibility.

The electrical installation is thus both optimised and high-performance.



Optimum system performance is ensured by coordination between the protection circuit breakers and the busbar trunking used for decentralised distribution.



Decentralised electrical distribution with total coordination perfectly satisfies all your requirements in terms of safety, continuity of service, upgradeability and simplicity.



Decentralised electrical distribution with total coordination is the ideal solution for a wide range of applications including factories, warehouses, commercial premises, parkings, etc.

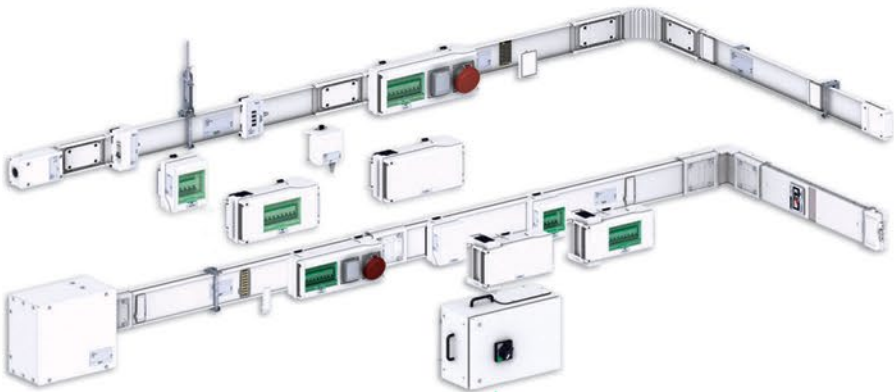

... lighting and power distribution in all types of buildings

Easier

• Coordination

Schneider Electric proposes coordinated busbar trunking and circuit breaker combinations for all your applications.

For typical applications with power ratings up to 630 kVA, a solution including the low-voltage electrical switchboard, circuit breakers and Canalis busbar trunking ensures an installation sized to handle all short-circuit levels encountered.

• Design

The electrical installation can be designed without knowing the exact location of the equipment to be supplied.

• Operation

Canalis opens the door to total upgradeability throughout the installation.

Connectors with standard performance circuit breakers can be installed at any point along the busbar trunking run.

Safer

• Decentralised distribution system

The combination of cascading and discrimination techniques guarantees optimum safety and continuity of service.

• Design

Total discrimination for enhanced protection as standard and at a lower cost point de la canalisation.

• Operation

Any changes to your installation are carried out in complete safety.

Connectors can be plugged in and out with the trunking live. They are equipped with interlocking systems to prevent incorrect mounting.

Coordination guarantees their installation at any point on the busbar trunking system.



Panorama of Canalis range

PB12259



Lighting and low power distribution from 25 to 40 A - IP55

Rated service current	Rated insulation voltage	Color	Line components	
Inc	Ui		Length of components	Number of conductors
KBA				
25 A 40 A	690 V	Pre-lacquered white (RAL9003)	2 m and 3 m	2 or 4 + PE
KBB				
25 A 40 A	690 V	Pre-lacquered white (RAL9003)	2 m and 3 m	Single circuit 2 or 4 + PE Dual circuit 2 + 2 + PE 2 + 4 + PE 4 + 4 + PE

PD020221_L_KN



Power distribution from 40 to 160 A - IP55

Inc	Ui		Length of components	Number of conductors
KN *				
40 A 63 A 100 A 160 A	500 V	Pre-lacquered white (RAL9001)	2 m and 3 m	4 + PE

* Canalis KN range is available on se.com

PB115580-30

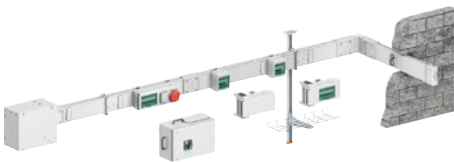

Horizontal and vertical distribution from 100 to 1000 A - IP55

Inc	Ui		Length of components	Number of conductors
KS *				
Aluminium: 100 A, 160 A, 250 A, 400 A, 500 A, 630 A, 800 A, 1000 A	Copper: 160 A, 250 A, 400 A, 630 A, 800 A	690 V	Pre-lacquered white (RAL9001)	3 m, 5 m and additional or customized components

* Canalis KS range is available on se.com or catalogue: DEBU026EN

PD020288-74_J



Power transmission and distribution from 800 to 6300 A - IP55

Inc	Ui		Length of components	Number of conductors
KT *				
Aluminium: 800 A, 1000 A, 1250 A, 1600 A, 2000 A, 2500 A, 3200 A, 4000 A, 5000 A	Copper: 1000 A, 1350 A, 1600 A, 2000 A, 2500 A, 3200 A, 4000 A, 5000 A, 6300 A	1000 V	Pre-lacquered white (RAL9001)	2 m and 4 m 3P + PE 3P + N + PE 3P + N + PER

* Canalis KT range is available on se.com or catalogue:
KTA: ref. DEBU021EN / KTC: ref. DEBU024EN

DB410226

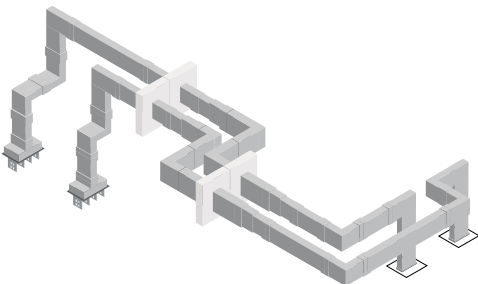

Power transmission for outdoor and harsh environment from 800 to 6300 A - IP68

Inc	Ui		Length of components	Number of conductors
KR *				
800 A, 1000 A, 1250 A, 1350 A, 1600 A, 2000 A, 2500 A, 3200 A, 4000 A, 5000 A, 6300 A	1000 V	Gray (RAL7030)	Up to 3 m	3L 3L + N or 3L + PE or 3L + PEN 3L + N + PE

* Canalis KR range is available on se.com or catalogue ref. DEBU031EN

Panorama of Canalis range



Branching points			Accessories	
Center to center distance		Protection type		
0.5 m, 1 m on 1 side	L + N + PE or 3L + N + PE (10/16 A) pre-cabled or to be cabled, with phase selection or fixed polarity, with lighting control	With fuses or without protection	<ul style="list-style-type: none"> > Flexible components > Fixing devices with quick adjustment > Communication bus (DALI, KNX, ASI) > Cable ducts 	
0.5 m or 1 m on 1 or 2 sides	L + N + PE or 3L + N + PE (10/16 A) pre-cabled or to be cabled, with phase selection or fixed polarity, with lighting control	With fuses or without protection	<ul style="list-style-type: none"> > Flexible components > Fixing devices with quick adjustment > Communication bus (DALI, KNX, ASI) > Cable ducts 	
Center to center distance		Protection type		
0.5 m, 1 m on 1 side	16 A to 63 A (plug-in)	Units for modular circuit breakers, fuses and sockets	<ul style="list-style-type: none"> > Flexible components > Fixing devices with quick adjustment > Remote control bus > Cable ducts > Installation accessories 	
Center to center distance		Protection type		
0.5 m or 1 m on each side for horizontal version, and on one side for vertical version	16 A to 400 A (plug-in)	Units for circuit breakers (modular, Compact NSX), fuses, sockets	<ul style="list-style-type: none"> > Riser ducting offer > Fixing devices with quick adjustment > Cable ducts > Installation accessories > Fire barriers 	
Center to center distance		Protection type		
0.5 m or 1 m	25 A to 630 A (plug-in) 400 A to 1250 A (bolt-on)	Units for circuit breakers (modular, Compact NSX), fuses, sockets	<ul style="list-style-type: none"> > Power supply ends > Direction change angles and T-pieces > Fixing devices and fuses 	
Center to center distance		Protection type		
-	-	-	<ul style="list-style-type: none"> > Power supply ends > Direction change angles and T-pieces > Fixing devices > Fire resistant elements 	



- Offices
- Workshops
- Car parks
- Supermarkets
- Logistics centers
- Data-centers

Canalis KB is a simple and economical solution for lighting and low power distribution

Lighting management is an essential means of providing users with greater comfort, whilst at the same time reducing their energy bill.

An affordable, easily-implementable solution for medium-sized tertiary buildings and workshops is available:

Canalis in combination with DALI or KNX protocols



Greater comfort for users

Lighting management makes it possible to compensate for light variations due to weather and sunlight by creating a uniform luminous flux. A well-lit workstation has a direct impact on the well-being of the employees and the quality of their work, as well as on their safety.

And better energy efficiency

Controlling lighting by zone, creating lighting scenarios on the basis of occupancy time, switching off lights in unoccupied zones, etc. Lighting management optimises the use of equipment to significantly reduce electricity consumption.

35%

Lighting share of a building's electricity consumption

20%

Achievable savings thanks to energy management



Power distribution is a major challenge in the construction and refurbishment of commercial, industrial buildings and data centers.

The choice of device is fundamental as it will have an effect on the building's lifecycle. Infrastructures must comply with existing requirements while being flexible, networked and smart. The Canalis concept is undoubtedly the best solution to meet the needs of today and the challenges of tomorrow.

Simple to estimate

Designing Canalis installations is straightforward as there is no need to know the exact location, nor the power rating of the loads to be supplied.

It is therefore very quick to cost the distribution functions. Moreover, Canalis's flexibility means you can invest in existing needs without adversely affecting future expansion.

Practical to recycle

Over the last 20 years, recycling has become a major challenge for industry.

The composition of Canalis ranges guarantees a 95% recycling rate.

But the Canalis offers go one better... if a site is being restructured or enlarged, the products can simply be removed and reinstalled in their new environment.

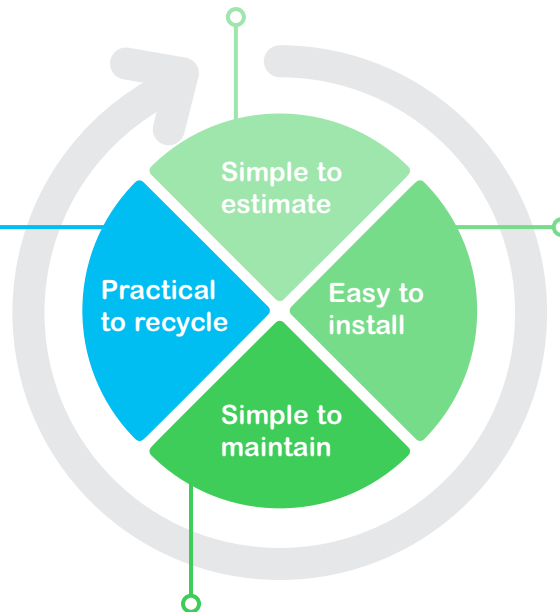

Easy to install

The compact nature of Canalis makes it easy to integrate in all parts of the building.

Since it is based on a decentralized architecture, Canalis can be installed at the same time as the building is being built, which optimizes site construction schedules.

Because of the delayed differentiation linked to the Canalis architecture, new constraints can be taken into account without adding to the installation time.

The Canalis ranges are factory-tested, which ensures a very high level of quality on site and considerably improves the success of site acceptance tests.

Simple to maintain

- **No maintenance is required on the Canalis electrical contacts.**
 - The clarity of the Canalis architecture simplifies building maintenance and upgrades:
 - > enlarging office space,
 - > adding check-outs in a supermarket...
- Decentralized distribution ensures continuity of service;** when associated with a 100% maintained or non-maintained supply, the essential functions are guaranteed:
- > maintaining the cold chain in a hypermarket,
 - > lighting system in a car park...

Canalis tools and services

Quotation and Design tools

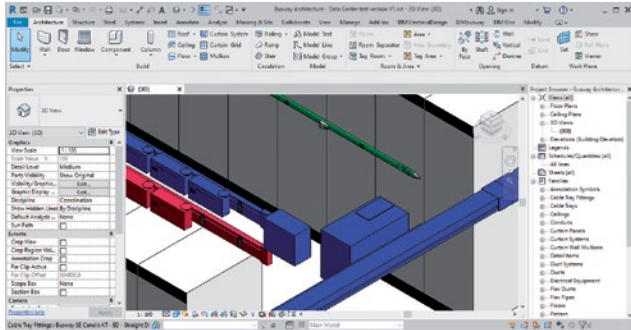

CanBrass

> is a design and costing tool for Canalis busbar trunking runs.

CanCad

> is a Plug-in for Autocad. It allows to easily design and get bill of materials.



BIMBusway

> is a Plug-in for Revit. It allows to easily design and get bill of materials in BIM format.

Solution for Data Center

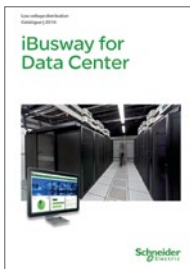

iBusway for Data Center catalogue

> DEBU028EN

iBusway for Data Center brochure

> DEBU027EN

Solution for lighting management



iBusway for lighting management: Canalis-DALI technical installation guide

> DEBU032EN

iBusway for lighting management brochure

> DESWED112002EN

Lighting technical guide

> A9GT15E

LED Lighting technical guide

> CA909008E

Application sheets/Technical guides



In cruise ships

> DESWED105014EN

In livestock production buildings

> DESWED105010EN

In logistic centres

> DESWED105011EN

Automotive industry guide

> KD0C98CTAAUEN

In car parks

> DESWED108011EN

In greenhouses

> DESWED105013EN

In garages

> DESWED106004EN

Hypermarkets guide

> KD0C98CTAHYEN

+ Download a wide selection of Cahiers Techniques from www.se.com



A

OFFICE

Canalis KB is a fast and easy mounting solution

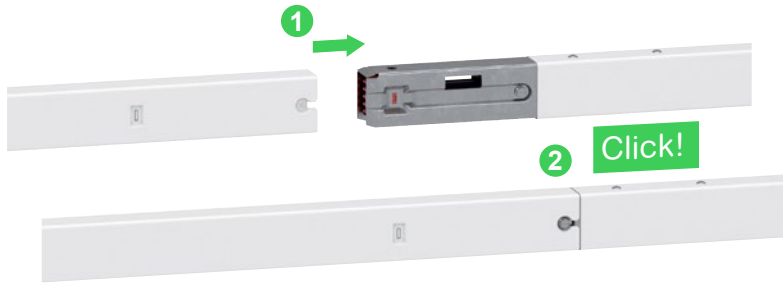

Easy to extend

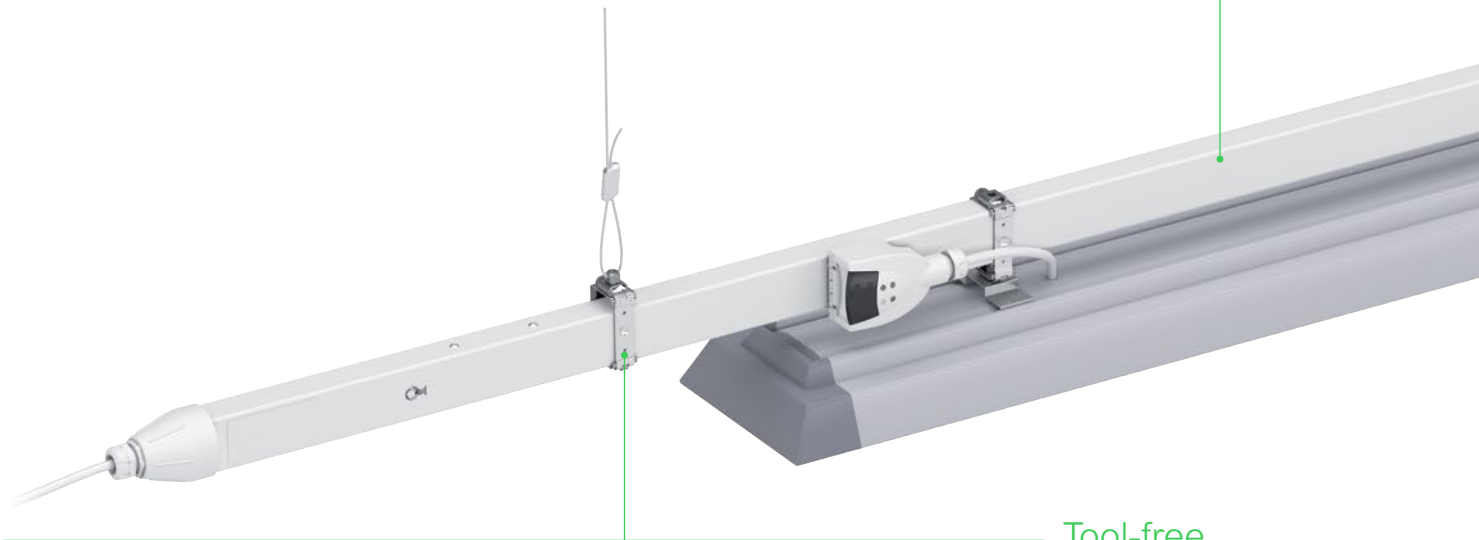

Tool-free

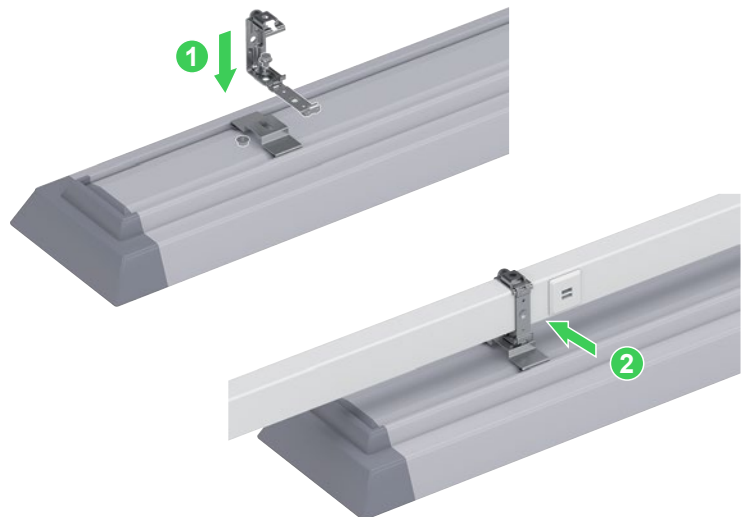
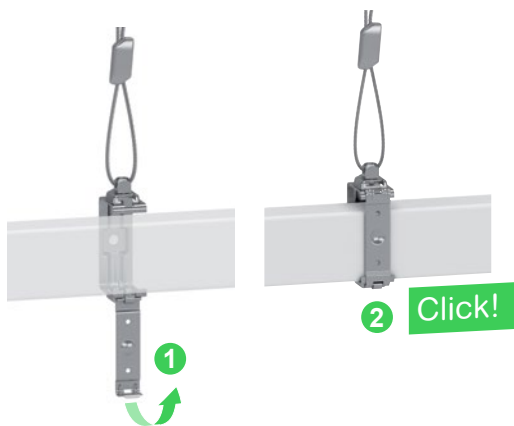

Canalis KB is a safe and robust solution

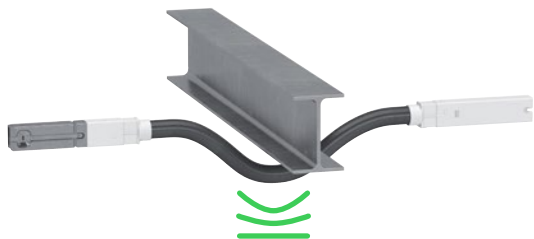

Flexible installation

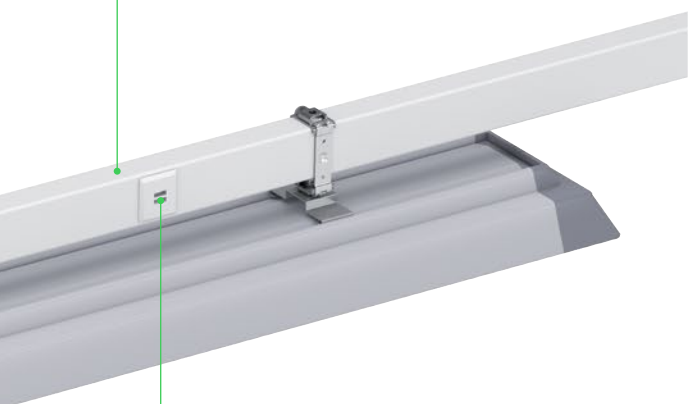

Tool-free

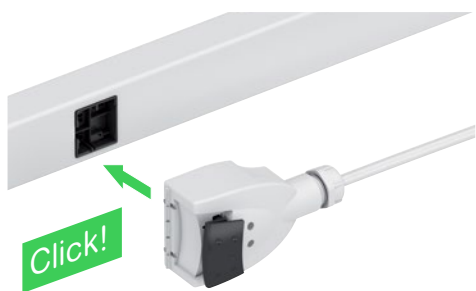

A high degree of protection

IP55 guarantees trunking protection against splashes and dust.

Canalis KB complies with **sprinkler tests**, guaranteeing operation under vertically and horizontally sprayed water for 50 minutes.

The high degree of protection for Canalis KB means it can be installed in all types of buildings.



No toxic emission in case of fire

All components in the KBA range are **halogen free**.

In case of fire, Canalis KBA does not release smoke or toxic gases.



Very rigid

Canalis KB trunking forms a rigid beam, even at the junction between two lengths.

Its facilitates the alignment of the luminaires.

Main characteristics

Rated current 25 A or 40 A.

Rated Operational voltal 230 or 400 V.

IP 55.

IK 06.

Color White RAL9003.

Compliant with protocols DALI and KNX.



Canalis KB is a comprehensive solution

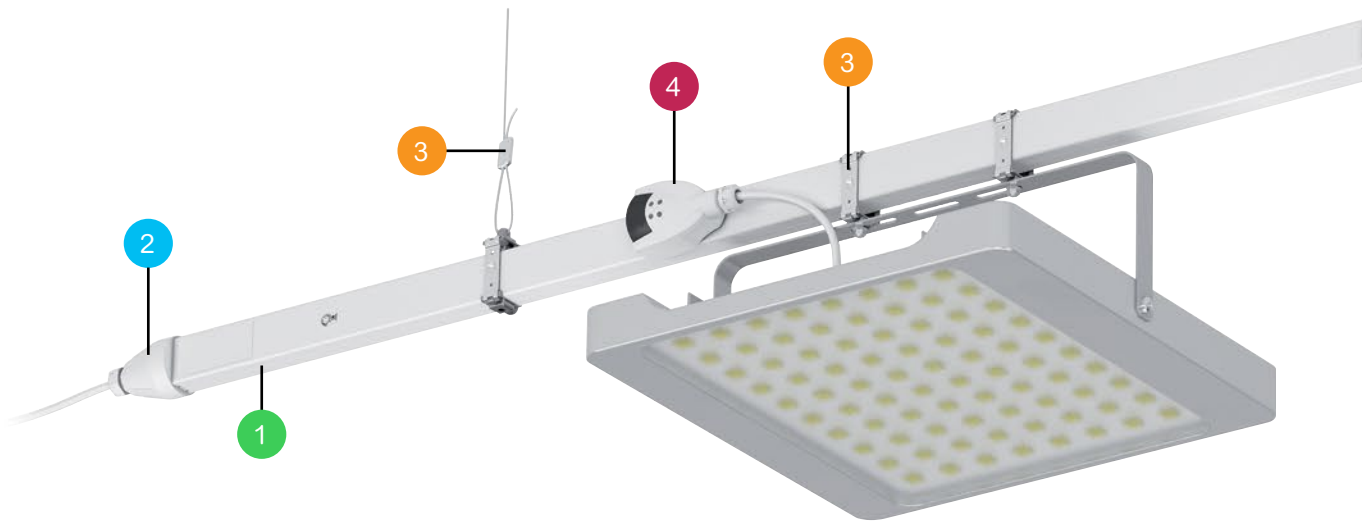

1. Run components

- Rating: 25 or 40 A.
- 2 or 4 live conductors.
- Basic lengths: 2 and 3 metres.

Canalis KBA

1 circuit

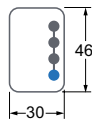

2. Feed units and end covers

- The feed units delivered with the end coverry receive the cables supplying one end of Canalis KB trunkings.

Canalis KBA



Canalis KBB

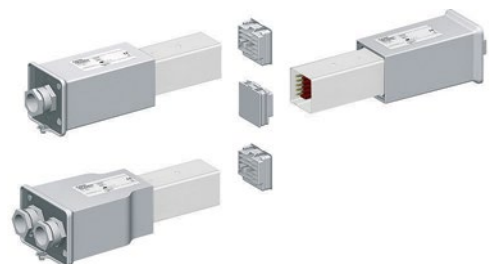

Canalis KBB

1 or 2 circuits

Reinforced mechanical structure

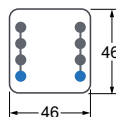

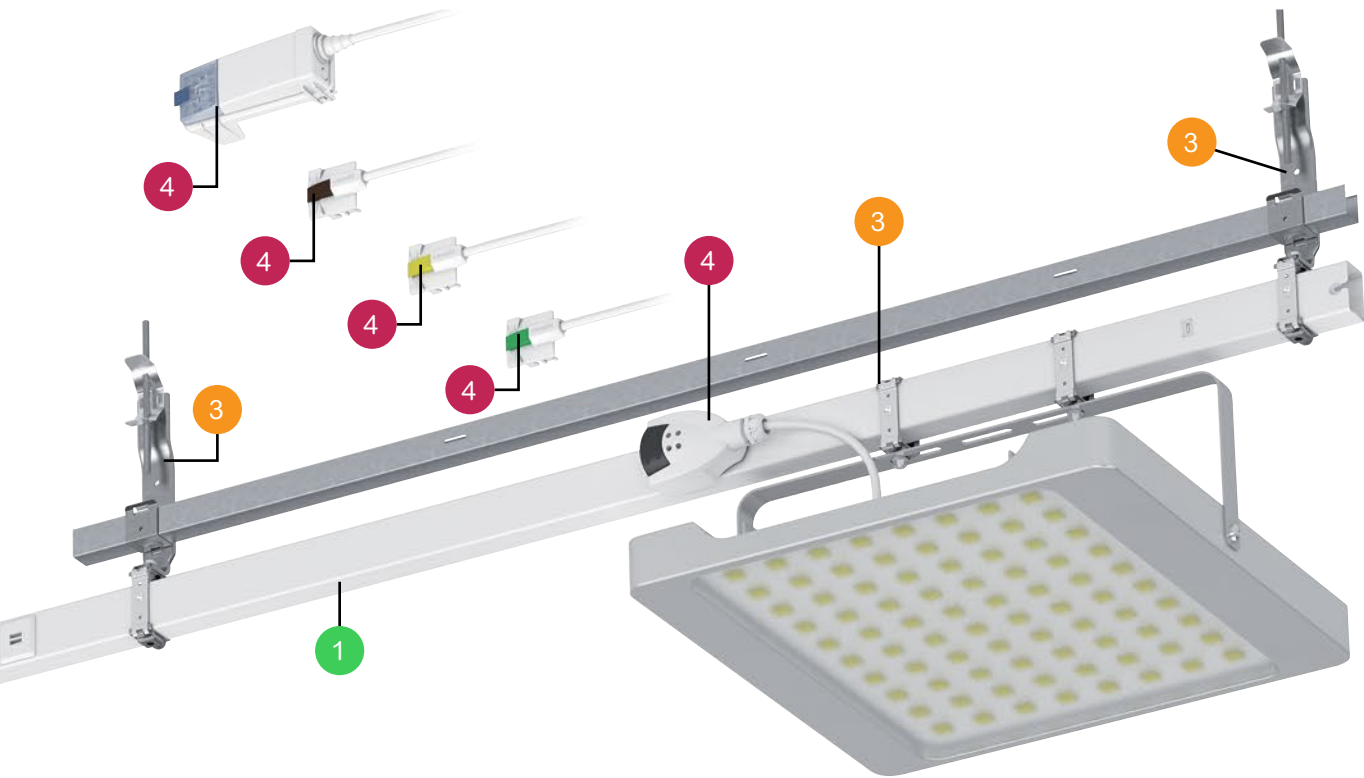

3. Fixing system and cable trays

- The fixing system ensures that Canalis KB is well secured, whatever the type of building structure. There are also fixings to secure the luminaires to Canalis KB.
- A metal duct is available for running other circuits such as emergency lighting, low-current circuits, etc.



4. Connectors

- The 10 and 16 A connector pre-wired or not, offer phase selection or fixed polarities, and can be used on KBA and KBB ranges.

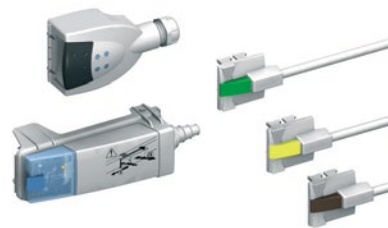

Description

Straight lengths

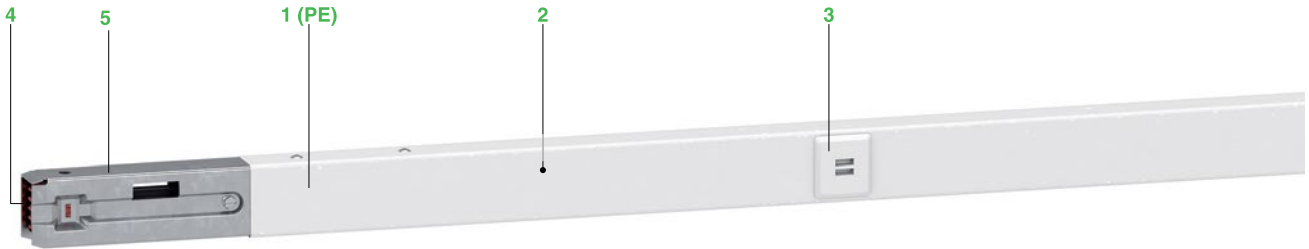

Straight lengths constitute the basic structure of the line and are made up of:

- 1 an all-in-one carrier casing, crimp closed, forming a rigid beam made of sheet steel, in RAL 9003 white lacquered sheet steel, hot galvanised on both sides.
This casing also acts as the protective earth conductor (PE),
- 2 a ribbon cable with two or four copper conductors,
- 3 one, two, three or five connector outlets,
- 4 an electrical jointing unit ensuring automatic and simultaneous connection of all live conductors,
- 5 a mechanical joining device made of galvanised sheet steel that makes the connection of two lengths rigid and resistant to bending.

The degree of protection is IP55 (without accessories).

The busbar trunking is non-flame-propagating as per the recommendations of standard IEC 60332-3. All the insulating and plastic materials are halogen-free and have enhanced fire-withstand capabilities (incandescent wire test as per standard IEC 60695-2).

- 960°C for components in contact with live parts.
- 650°C for other components.

Multi-circuit possibilities

The many possibilities offered by KBB trunking means specialised circuits can be created, e.g. for emergency lighting, presence detection, dimming.

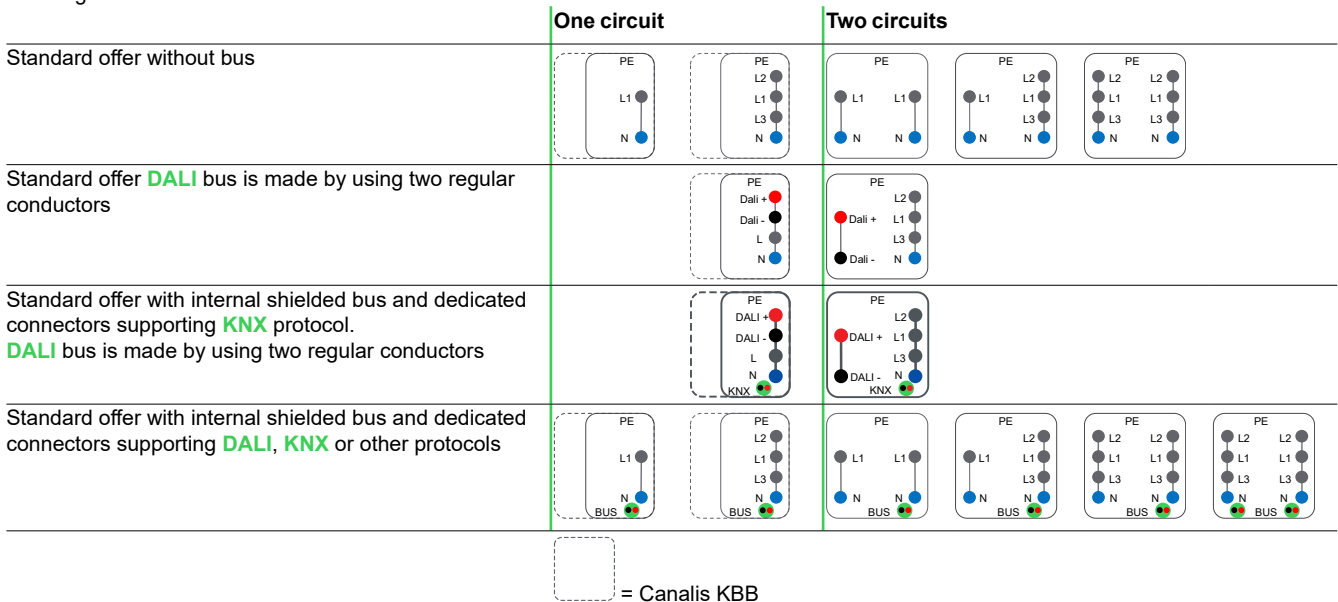

For attachment of the busbar trunking to the structure of the building, either directly or via a threaded rod, chain or steel cable (the latter two with a pigtail hook or a closed ring).

- Designed to relieve the installer of the weight of the busbar trunking once placed in a bracket.
- Automatic locking of moving part on closing (unlocking requires a tool).
- The maximum recommended fixing distance is: 3 metres.

- 1 Universal fixing bracket** KBA40ZFU or KBB40ZFU
For suspension on a threaded rod, diameter 6 mm.
For horizontal mounting on a beam, pendant, wall, etc.
- 2 Cable suspension system** KBA40ZFSU or KBB40ZFSU
Cuts mounting time of the fixing system to one-third of that required for threaded rods.
Enables height adjustment of the trunking.
- 3 Adjustable, threaded-rod suspension system** KBB40ZFPFU
For suspension on a threaded rod, diameter 6 mm.
A spring system locks the threaded rod in position for fast adjustment of the trunking.
- 4 Pigtail hook** KBB40ZFC
For suspension by a chain.
- 5 Closed ring** KBB40ZFC6
Mounted on the luminaire for suspension.
- 6 Raiser** KBB40ZFMP
For mounting on wall or false floor.
- 7 Open hook** KBB40ZFC5
To suspend the luminaire.

Luminaires

Attached to the luminaires before mounting, these fixings ensure fast and direct fixing to Canalis KB.

- Same catalogue numbers as the busbar fixings.
 - Automatic locking of moving part on closing.
 - Use with an open hook and/or closed ring enables suspension.
- 8 Double universal fixing bracket** KBA40ZFU2W or KBB40ZFU2W for heavy luminaires.

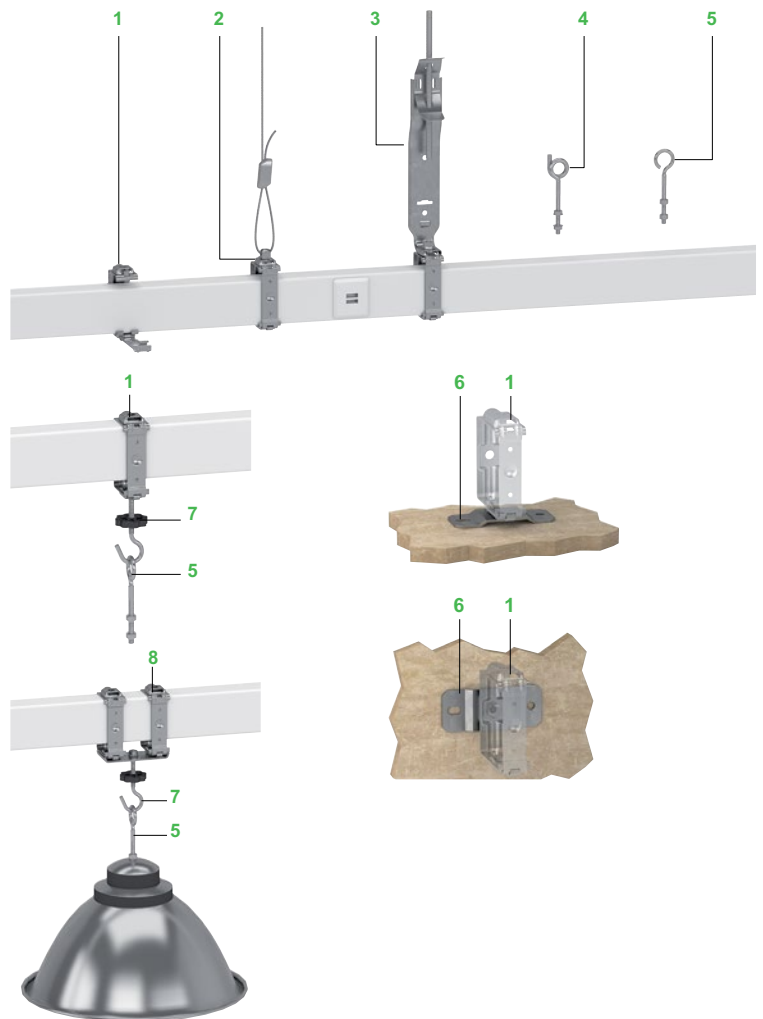

Cable support

For running adjacent circuits such as emergency lighting, low-current circuits, etc.

- 1 Cable brackets** KBB40ZFGU
Clips to trunking for fast mounting. It is possible to run three cables (diameter 5 to 16 mm) and two IRL tubes.
- 2 Cable duct** KFB25CD253
The cable duct fits on support KBB40ZFG1, which in turn fits onto a threaded rod suspension system KBA40ZFPFU. An intermediate support is placed between the duct and the trunking if the distance between the suspension points exceeds 2 metres. Each duct is equipped with a connection device.

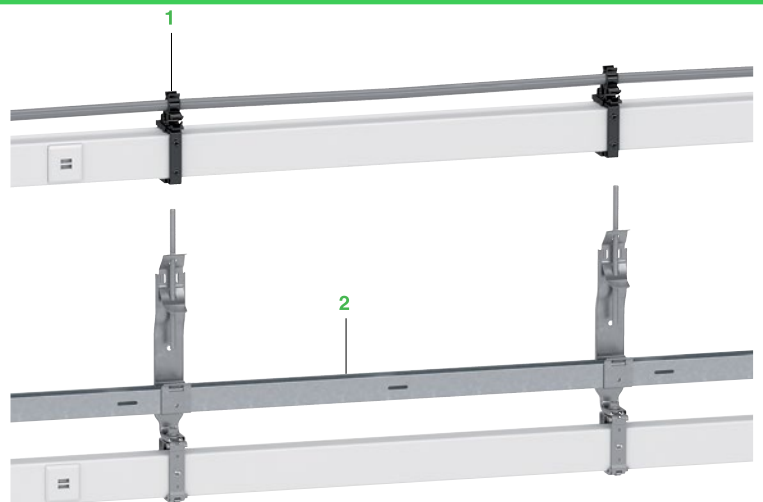

Options

Empty length (no electric circuit)

Used to adjust line length to building dimensions (e.g. to reach a fixing point).

Two metres long, can be cut on site.
KBA40EDA20W or KBB40EDA20W.

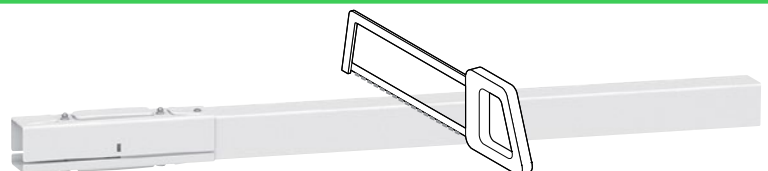

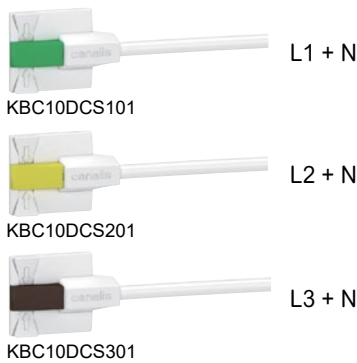

Connectors (general)

For instantaneous connection of luminaires to busbar trunking:

- they can be handled while energised and under live conditions
- the contacts for live conductors are of the clamp type
- PE connection occurs before that of the phases and neutral
- phase-selection system (clip-in contact studs) for balancing of 3-phase distribution systems
- selection is visible via a transparent window
- a coloured lock holds them in the connector outlet
- all the insulating and plastic materials have a high fire-retardant capacity:
 - incandescent-wire test in compliance with IEC 60695-2:
 - 960°C for components in contact with live parts,
 - 650°C for other components.

All the insulators and plastic components are **halogen free**.

Connectors 10 A direct pre-wired - 0.8 m

Pre-wired with SO5Z1Z1-F 3 x 1.5 mm² cable, 0.80 m long, pre-stripped on luminaire end:

- 10 A rating
- fixed L + N + PE polarity
- the various models make it possible to balance 3-phase distribution systems.

The colour of the lock and the casing enable remote identification of the polarity.

- 1 Live-conductor contacts.
- 2 Protective-conductor contact.
- 3 Lock.

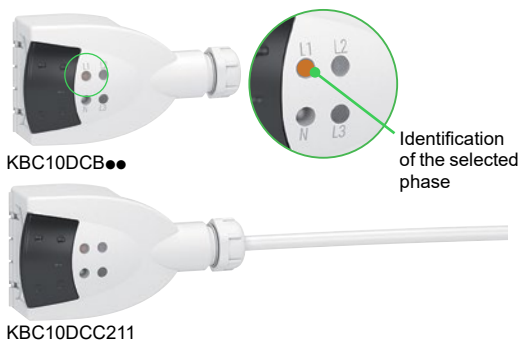
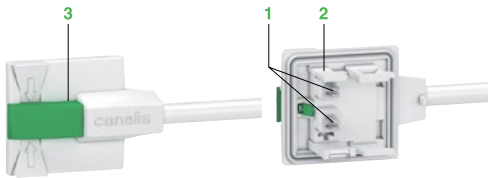

Connectors 10 A direct with phase selection

- The two contact studs are movable and can be used to set up both L + N + PE and 2L + PE distribution.
- Supplied complete with a cable gland.

Pre-wired

Type DCC

- Pre-wired with SO5Z1Z1-F 3 x 1.5 mm² cable, 1 m long, pre-stripped on luminaire end.
- If prefabricated leads are used, the line must have 16 A protection (see possibilities of dispensing with protection in the simplified design guide for lighting distribution, in the section on protection against overloads).

To be wired

Type DCB

- To be wired for connection of luminaires using a cable of specific type, size or length.
- Fast connection for 3 x 0.75 to 1.5 mm² cable. If prefabricated leads are used, the line must have 16 A protection (see possibilities of dispensing with protection in the simplified design guide for lighting distribution, in the section on protection against overloads).





KBC16DCB●●



KBC16DCF●●



KBC16DCP●●

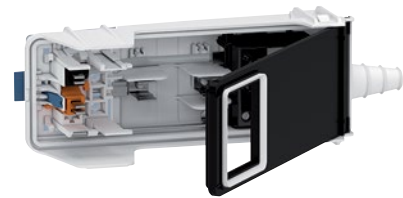

Connectors 16 A with phase selection not wired

- Phase selection: L+N or 2L (mobile studs)
- Terminal connections for 0.75 to 1.5 mm² cable.
- Supplied with a cable bushing.
- Installation is facilitated by the side guides.
- Exist with 3L+N or with fixed polarity as well.

Without protection

Type DCB

For direct connection of luminaires using a specific cable.

Can be equipped with the accessory to connect the remote-control circuit to the luminaires.

For protection with fuses (not provided)

Type DCF

For cylindrical fuse NF 8.5 x 31.5 (not supplied), 16 A gG maximum, breaking capacity 20 kA.

Type DCP

With cylindrical fuse NF 8.5 x 31.5 (supplied), 16 A gG maximum, breaking capacity 20 kA.

Supplied with power socket NF or VDE standard - 2P+T 10/16 A, 250 V.

Interlocking device

For all 10 A and 16 A connectors.

A set of three interlocking devices in different colours can be used to mechanically lock out connector when two or three different distribution networks are present (load, voltage, frequency, etc.). KBC16ZL10, KBC16ZL20 or KBC16ZL30.

- An interlocking device is made up of a handle and an interlocking device on each end. It can be used for an outlet and the corresponding connector.
- Interlocking devices are supplied with labels that can be placed on the connector and the trunking for identification.

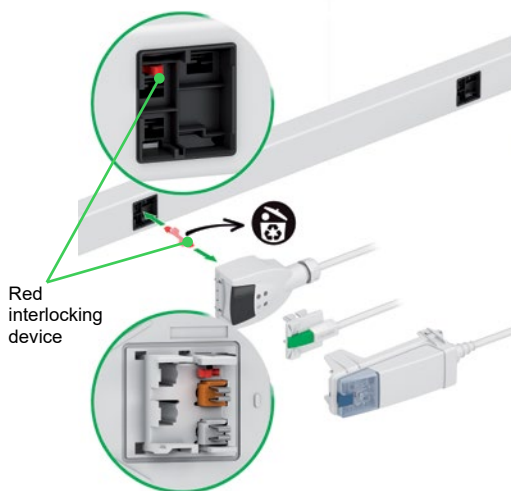

Red interlocking device

Accessories

Rear support bracket KBC16ZC1

Additional fixing of KBC16 connector using the rear support bracket may be necessary, notably if there is a risk of accidental pulling on the cable or if the cable is very heavy (great length).



KBC16ZC1



KBC16ZB1

Outlet blanking plate KBC16ZB1

Spare part intended to restore IP55 on an outlet following removal of the connector (if original blanking plate is lost).

Description

Control system

3 possible solutions

For DALI protocol only

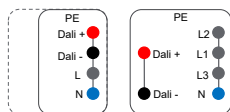
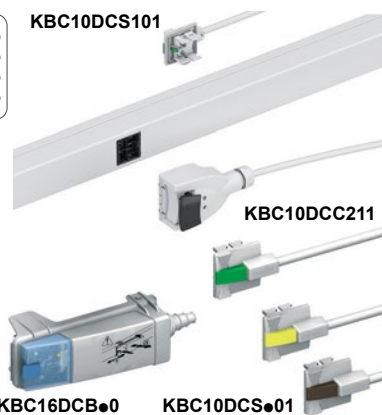
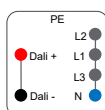
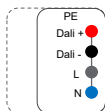

Are Can be

Straight lengths

Two of the conductors are dedicated to the communication bus.

Connectors

The connector is common for both power and communication. Connectors can be equipped with two cables. One to feed the power and one green for the control of the device.

A lock system avoid connection to the non proper line.

Bus characteristics

DALI	Unit	Values
Cross-section and type of conductor	mm ²	2 x 2.5 copper
Rated insulation voltage (Ui) (between power circuit and bus)	V	690
Rated operational voltage (Ue) (max. U between bus + and - poles)	V	230 to 400
Maximum operational current (Ie)	A	25
Linear resistance	mΩ/m	52
Linear capacitance	pF/m	30
Maximum recommended length	m	300

For combined DALI and KNX protocols

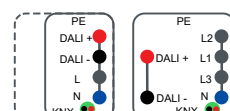
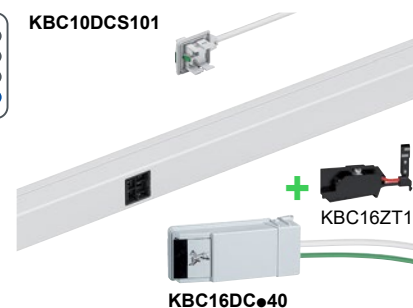
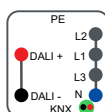
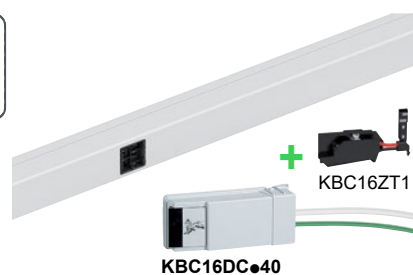
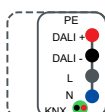

Straight lengths

A internal shielded decated bus is use to connect KNX devices. This bus is a KNX certified bus.

2 conductors are dedicated to the communication DALI. Only proper connectors can be installed.

Connectors

Connectors are common for both power and communication. Allow with the same connector to feed power to luminaires and A lock system avoid to connect it on a non proper line.

Bus characteristics

See DALI and KNX bus characteristics.

Description

Control system

3 possible solutions

For **KNX** protocol alone or other protocols needing a **shielded bus**

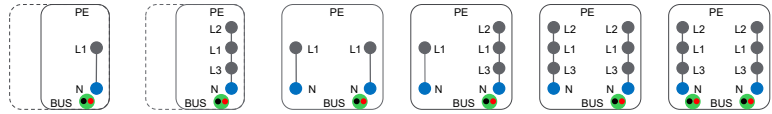
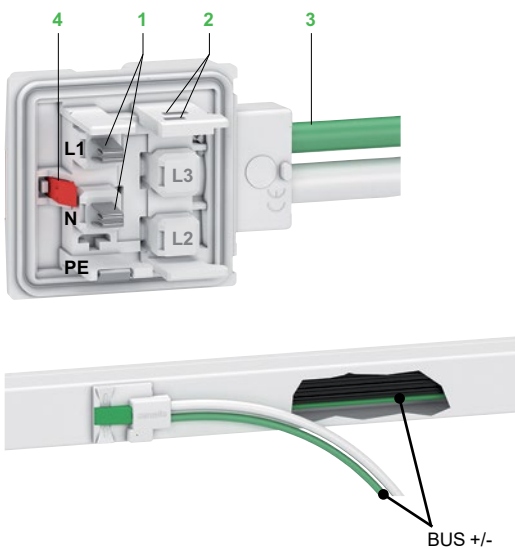
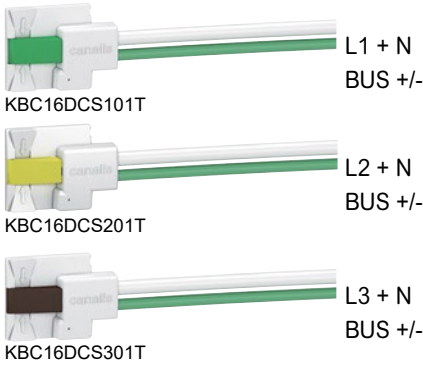

Straight lengths

A internal shielded decated bus is use to connect KNX devices. This bus is a KNX certified bus.

Connectors

Connectors are common for both power and communication. Alow with the same connector to feed power to luminaires and a lock system avoid to connect it on a non proper line.

The colour of the lock and the casing enable remote identification of the polarity.

- 1 Live-conductor contacts.
- 2 Bus conductor contacts.
- 3 Bus cable.
- 4 Lock.

Bus characteristics

KNX	Unit	Values
Cross-section and type of conductor	mm ²	2 x 0.5 copper
Rated insulation voltage (Ui) (between power circuit and bus)	V	500
Rated operational voltage (Ue) (max. U between bus + and - poles)	V	32
Maximum operational current (Ie)	A	3.8
Linear resistance	mΩ/m	75
Linear capacitance	pF/m	100
Maximum KNX recommended length	m	300

16 A for circuit breaker and fuses

Connection of the remote-control receiver using a KBC16DCB, KBC16DCF or KBC16DCP connector equipped with a KBC16ZT1 contact-block accessory delivered with cable gland.

Feed units equipped with an additional bus terminal block. Connectors are equipped with two cables. One for the devices power and for the control the device.

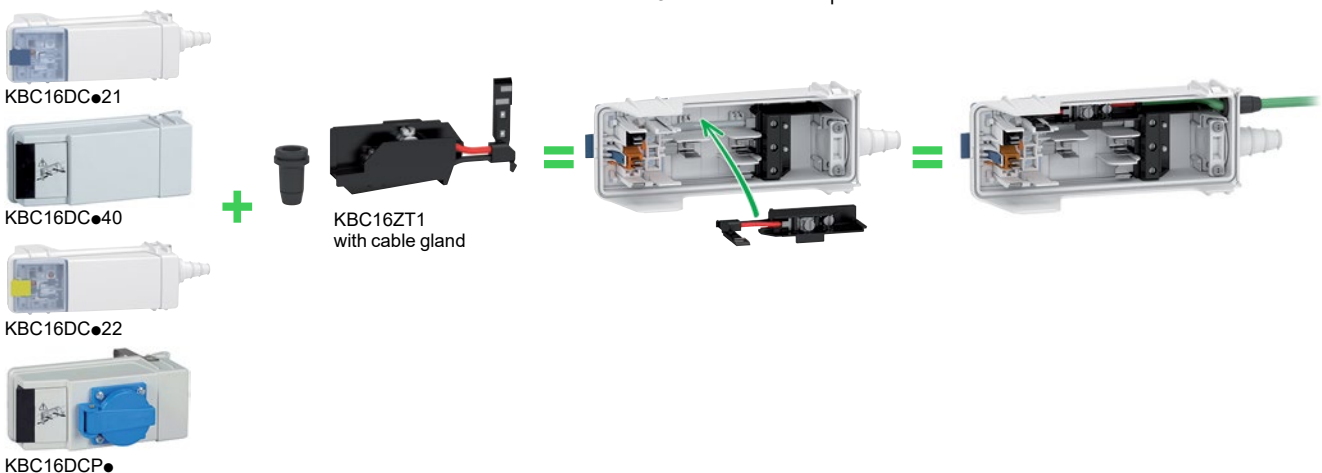

The offer is organised in 3 chapters

The essentials

Only 4 references to **simplify and faster** your choice

Classic offer

For **usual lighting or power distribution** without communication bus

Control system

For lighting or any other devices controlled with **DALI or KNX** protocols

Catalogue numbers

The essentials

Only 4 references

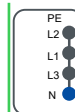

25 A

ED - Straight length

 KBA25ED4303W	Type of component	Length (m)	Number of outlets	Catalogue numbers
	Distribution length	3	3	Order in multiples of 6 KBA25ED4303W

AB - Feed unit

 KBA25ABG4W	Mounting	Terminals (mm ²)	Cable gland max Ø (mm)	Catalogue numbers
	Left	4	PG16 Ø15	Order in multiples of 1 KBA25ABG4W

ZF - Fixing bracket

 KBA40ZFU	Type of component	Mounting	Catalogue numbers
	Universal fixing bracket	Suspended on threaded rod or lateral (except wall)	Order in multiples of 10 KBA40ZFU

DCB - Connector direct not wired 10 A with phase selection

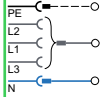
 KBC10DCB20	Polarity	Scheme	Catalogue numbers
	L1 + N or L2 + N or L3 + N		Order in multiples of 10 KBC10DCB20



Classic offer

Line components



25 A

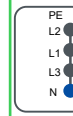

40 A







25 A

40 A





ED - Straight lengths

	Length (m)	Distance between outlets (m)	Number of outlets	Catalogue numbers Order in multiples of 6			
 KBA••ED•••••W	3	0.5	5	KBA25ED2305W	KBA40ED2305W	KBA25ED4305W	KBA40ED4305W
		1	3	KBA25ED2303W	KBA40ED2303W	KBA25ED4303W	KBA40ED4303W
		1.5	2	KBA25ED2302W	-	KBA25ED4302W	-
 KBB••ED•••••W	2	-	0	KBA25ED2300W	KBA40ED2300W	KBA25ED4300W	KBA40ED4300W
		0.5	3	KBA40ED2203W	KBA40ED2203W	KBA40ED4203W	KBA40ED4203W
		1	2	KBA25ED2202W	-	KBA25ED4202W	-



AB - Feed units

	Mounting	Terminals (mm ²)	Cable gland max Ø (mm)	Catalogue numbers Order in multiples of 1			
 KBA25ABG4W	Left	4	PG16 Ø15	KBA25ABG4W	-	KBA25ABG4W	-
 KBA40ABG4W KBB40ABG44W	Left	10	PG21 Ø19	KBA40ABG4W	KBA40ABG4W	KBA40ABG4W	KBA40ABG4W
 KBA40ABD4W KBB40ABD44W	Right	10	PG21 Ø19	KBA40ABD4W	KBA40ABD4W	KBA40ABD4W	KBA40ABD4W
 KBA40ABT4W  KBB40ABT44W	Central	10	PG21 Ø19	KBA40ABT4W	KBA40ABT4W	KBA40ABT4W	KBA40ABT4W

DF - Flexibles

	Type of component	Length (m)	Catalogue numbers Order in multiples of 1			
 KBA40DF405W	Flexible	0.5	KBA40DF405W	KBA40DF405W	KBA40DF405W	KBA40DF405W
 KBA40DF420W		2	KBA40DF420W	KBA40DF420W	KBA40DF420W	KBA40DF420W
 KBB40DF405W - KBB40DF4405W						
 KBB40DF420W - KBB40DF4420W						

ZF - Fixing brackets

	Type of component	Mounting	Catalogue numbers Order in multiples of 10			
 KBA40ZFU KBB40ZFU	Universal fixing bracket	Suspended on threaded rod or lateral (except wall)	KBA40ZFU	KBA40ZFU	KBA40ZFU	KBA40ZFU
 KBA40ZFSU KBB40ZFSU	Cable suspension system	With 3 m steel cable	KBA40ZFSU	KBA40ZFSU	KBA40ZFSU	KBA40ZFSU

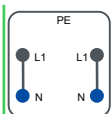

25 A

40 A

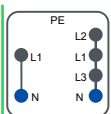

25 A

40 A

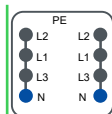

25 A

40 A

Catalogue numbers
Order in multiples of 6

-	-	KBB25ED42305W	KBB40ED42305W	KBB25ED44305W	KBB40ED44305W
KBB25ED22303W	KBB40ED22303W	-	-	-	-
-	-	-	-	-	-
KBB25ED22300W	KBB40ED22300W	KBB25ED42300W	KBB40ED42300W	KBB25ED44300W	KBB40ED44300W
KBB40ED22203W	KBB40ED22203W	KBB40ED42203W	KBB40ED42203W	KBB40ED44203W	KBB40ED44203W
-	-	-	-	-	-

Catalogue numbers
Order in multiples of 1

-	-	-	-	-	-
KBB40ABG44W	KBB40ABG44W	KBB40ABG44W	KBB40ABG44W	KBB40ABG44W	KBB40ABG44W
KBB40ABD44W	KBB40ABD44W	KBB40ABD44W	KBB40ABD44W	KBB40ABD44W	KBB40ABD44W
KBB40ABT44W	KBB40ABT44W	KBB40ABT44W	KBB40ABT44W	KBB40ABT44W	KBB40ABT44W

Catalogue numbers
Order in multiples of 1

KBB40DF405W	KBB40DF405W	KBB40DF4405W	KBB40DF4405W	KBB40DF4405W	KBB40DF4405W
KBB40DF420W	KBB40DF420W	KBB40DF4420W	KBB40DF4420W	KBB40DF4420W	KBB40DF4420W

Catalogue numbers
Order in multiples of 10

KBB40ZFU	KBB40ZFU	KBB40ZFU	KBB40ZFU	KBB40ZFU	KBB40ZFU
KBB40ZFSU	KBB40ZFSU	KBB40ZFSU	KBB40ZFSU	KBB40ZFSU	KBB40ZFSU



Classic offer

Line components - Reinforced single circuit

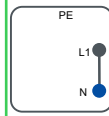

25 A

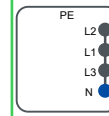

25 A

40 A

ED - Straight lengths

KBB25ED●●●●W	Length (m)	Distance between outlets (m)	Number of outlets	Catalogue numbers			
				Order in multiples of 6			
KBB25ED●●●●W	3	1	3	KBB25ED2303W	KBB40ED2303W	KBB25ED4303W	KBB40ED4303W
		-	0	KBB25ED2300W	KBB40ED2300W	KBB25ED4300W	KBB40ED4300W
KBB40ED●●●●W	2	1.5	2	KBB40ED2202W	KBB40ED2202W	KBB40ED4202W	KBB40ED4202W

AB - Feed units

KBB40ABG4W	Mounting	Terminals (mm ²)	Cable gland max Ø (mm)	Catalogue numbers			
				Order in multiples of 1			
KBB40ABG4W	Left	6 to 10	PG21 Ø19	KBB40ABG4W	KBB40ABG4W	KBB40ABG4W	KBB40ABG4W
KBB40ABD4W	Right	6 to 10	PG21 Ø19	KBB40ABD4W	KBB40ABD4W	KBB40ABD4W	KBB40ABD4W
KBB40ABT4W	Central	6 to 10	PG21 Ø19	KBB40ABT4W	KBB40ABT4W	KBB40ABT4W	KBB40ABT4W

DF - Flexibles

KBB40DF405W	Type of component	Length (m)	Catalogue numbers			
			Order in multiples of 1			
KBB40DF405W	Flexible	0.5	KBB40DF405W	KBB40DF405W	KBB40DF405W	KBB40DF405W
		2	KBB40DF420W	KBB40DF420W	KBB40DF420W	KBB40DF420W
KBB40DF420W						

ZF - Fixing brackets

KBB40ZFU	Type of component	Mounting	Catalogue numbers			
			Order in multiples of 10			
KBB40ZFU	Universal fixing bracket	Suspended on threaded rod or lateral (except wall)	KBB40ZFU	KBB40ZFU	KBB40ZFU	KBB40ZFU
KBB40ZFSU	Cable suspension system	With 3 m steel cable	KBB40ZFSU	KBB40ZFSU	KBB40ZFSU	KBB40ZFSU





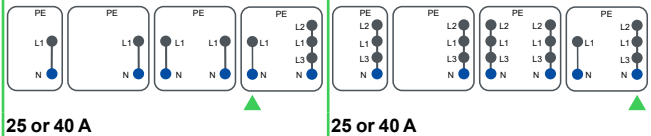

Classic offer

Connectors

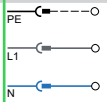

▲ Connector mounting side

DCS - 10 A - Connectors direct pre-wired - 0.8 m

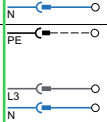
	Polarity	Scheme	Color	Catalogue numbers Order in multiples of 10
 KBC10DCS101	L1 + N		Green	KBC10DCS101
 KBC10DCS201	L2 + N		Yellow	-
 KBC10DCS301	L3 + N		Brown	-

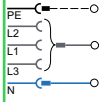

DCC - 10 A - Connectors direct pre-wired - 0.8 m - With phase selection

 KBC10DCC211	L1 + N or L2 + N or L3 + N		-	KBC10DCC211
--	----------------------------------	---	---	--------------------

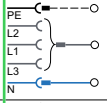
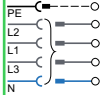

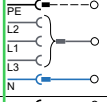

DCB - 10 A - Connectors direct not wired - With phase selection

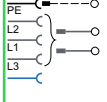
 KBC10DCB0	L1 + N or L2 + N or L3 + N		-	KBC10DCB20
	3L + N		-	KBC10DCB40

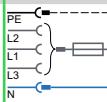

DCB - 16 A - Connectors direct not wired - With phase selection

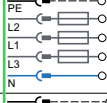
 KBC16DCB21	L1 + N or L2 + N or L3 + N		-	KBC16DCB21
 KBC16DCB40	3L + N		-	KBC16DCB40
 KBC16DCB22	L1 + L2 or L1 + L3 or L2 + L3		-	KBC16DCB22

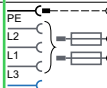
DCF - 16 A - Connectors for fuses not wired - With phase selection

	Polarity	Scheme	Protection	Catalogue numbers Order in multiples of 10
 KBC16DCF21	L1 + N or L2 + N or L3 + N		Cylindrical fuse NF 8.5 x 31.5 mm	KBC16DCF21
 KBC16DCF40	3L + N		Cylindrical fuse NF 8.5 x 31.5 mm	-
 KBC16DCF22	L1 + L2 or L1 + L3 or L2 + L3		Cylindrical fuse NF 8.5 x 31.5 mm	KBC16DCF22

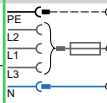

DCP - 16 A - Connectors with fuse and power socket not wired - With phase selection

	Polarity	Scheme	Protection	Catalogue numbers Order in multiples of 1
 KBC16DCP	L1 + N or L2 + N or L3 + N		NF 2P+T 10/16 A, 250 V	KBC16DCP1
	L1 + N or L2 + N or L3 + N		VDE 2P+T 10/16 A, 250 V	KBC16DCP2



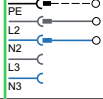

25 or 40 A

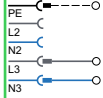
DCB - 16 A - Connectors direct not wired - With fixed polarity

	Polarity	Scheme	Catalogue numbers Order in multiples of 10
 KBC16DCB226	L2 + N2		KBC16DCB226
 KBC16DCB216	L3 + N3		KBC16DCB216

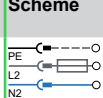
DCF - 16 A - Connectors for fuses not wired - With fixed polarity

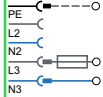
	Polarity	Scheme	Protection	Catalogue numbers Order in multiples of 10
 KBC16DCF226	L2 + N2		Cylindrical fuse NF 8.5 x 31.5 mm	KBC16DCF226
 KBC16DCF216	L3 + N3		Cylindrical fuse NF 8.5 x 31.5 mm	KBC16DCF216



Control system

Line components for DALI protocol

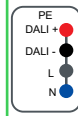

25 A

40 A

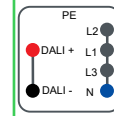

25 A

40 A

ED - Straight lengths							
	Length (m)	Distance between outlets (m)	Number of outlets	Catalogue numbers Order in multiples of 6			
 KBA25ED4305W	3	0.5	5	KBA25ED4305W	KBA40ED4305W	KBB25ED42305W	KBB40ED42305W
		1	3	KBA25ED4303W	KBA40ED4303W	-	-
		1.5	2	KBA25ED4302W	-	-	-
 KBB40ED42300W	2	-	0	KBA25ED4300W	KBA40ED4300W	KBB25ED42300W	KBB40ED42300W
		1	3	KBA40ED4203W	KBA40ED4203W	KBB40ED42203W	KBB40ED42203W
		1.5	2	KBA25ED4202W	-	-	-

AB - Feed units							
	Mounting	Terminals (mm ²)	Cable gland max Ø (mm)	Catalogue numbers Order in multiples of 1			
 KBA25ABG4W	Left	4	PG16 Ø15	KBA25ABG4W	-	-	-
 KBA40ABG4W KBB40ABG44W	Left	10	PG21 Ø19	KBA40ABG4W	KBA40ABG4W	KBB40ABG44W	KBB40ABG44W
 KBA40ABD4W KBB40ABD44W	Right	10	PG21 Ø19	KBA40ABD4W	KBA40ABD4W	KBB40ABD44W	KBB40ABD44W
 KBA40ABT4W KBB40ABT44W	Central	10	PG21 Ø19	KBA40ABT4W	KBA40ABT4W	KBB40ABT44W	KBB40ABT44W

DF - Flexibles							
	Type of component	Length (m)	Catalogue numbers Order in multiples of 1				
 KBA40DF405W	Flexible	0.5	KBA40DF405W	KBA40DF405W	KBB40DF4405W	KBB40DF4405W	
		2	KBA40DF420W	KBA40DF420W	KBB40DF4420W	KBB40DF4420W	
 KBA40DF420W							
 KBB40DF4405W							
 KBB40DF4420W							

ZF - Fixing brackets							
	Type of component	Mounting	Catalogue numbers Order in multiples of 10				
 KBA40ZFU KBB40ZFU	Universal fixing bracket	Suspended on threaded rod or lateral (except wall)	KBA40ZFU	KBA40ZFU	KBB40ZFU	KBB40ZFU	
 KBA40ZFSU KBB40ZFSU	Cable suspension system	with 3 m steel cable	KBA40ZFSU	KBA40ZFSU	KBB40ZFSU	KBB40ZFSU	

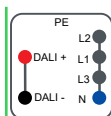



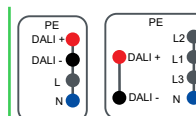

25 or 40 A



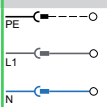

25 or 40 A

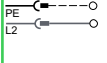
▲ Connector mounting side

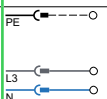
DCS - 10 A - Connectors direct pre-wired - 0.8 m

	Polarity	Scheme	Color	Catalogue numbers Order in multiples of 10	
 KBC10DCS101	L1 + N		Green	KBC10DCS101	KBC10DCS101
 KBC10DCS201	L2 + N		Yellow	-	KBC10DCS201
 KBC10DCS301	L3 + N		Brown	-	KBC10DCS301

DCC - 10 A - Connectors direct pre-wired - 0.8 m - With phase selection

 KBC10DCC211	L1 + L2 or L1 + L3 or L2 + L3		-	KBC10DCC211	KBC10DCC211
--	-------------------------------------	---	---	--------------------	--------------------



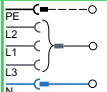
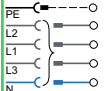

DCB - 10 A - Connectors direct not wired - With phase selection

 KBC10DCB0	L1 + N or L2 + N or L3 + N		-	KBC10DCB20	KBC10DCB20
	3L + N		-	KBC10DCB40	KBC10DCB40

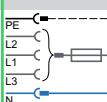

DCB - 16 A - Connectors direct not wired - With phase selection

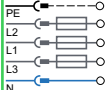
 KBC16DCB21	L1 + N or L2 + N or L3 + N		-	KBC16DCB21	KBC16DCB21
 KBC16DCB40	3L + N		-	-	KBC16DCB40
 KBC16DCB22	L1 + L2 or L1 + L3 or L2 + L3		-	KBC16DCB22	KBC16DCB22

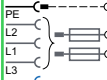
DCF - 16 A - Connectors for fuses not wired - With phase selection

	Polarity	Scheme	Protection	Catalogue numbers Order in multiples of 10	
 KBC16DCF21	L1 + N or L2 + N or L3 + N		Cylindrical fuse NF 8.5 x 31.5 mm	KBC16DCF21	KBC16DCF21
 KBC16DCF40	3L + N		Cylindrical fuse NF 8.5 x 31.5 mm	-	KBC16DCF40
 KBC16DCF22	L1 + L2 or L1 + L3 or L2 + L3		Cylindrical fuse NF 8.5 x 31.5 mm	KBC16DCF22	KBC16DCF22

DCP - 16 A - Connectors with fuse and power socket not wired - With phase selection

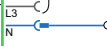
 KBC16DCP0	L1 + N or L2 + N or L3 + N		NF 2P+T 10/16 A, 250 V	KBC16DCP1	KBC16DCP1
	L1 + N or L2 + N or L3 + N		VDE 2P+T 10/16 A, 250 V	KBC16DCP2	KBC16DCP2

Control system

Line components for combined **DALI** and **KNX** protocols

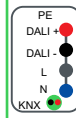

25 A

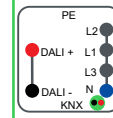

40 A





25 A

40 A





ED - Straight lengths

		Type of component	Length (m)	Number of outlets	Catalogue numbers Order in multiples of 6			
 KBA••ED•••••TW	Distribution length		3	5	KBA25ED4305TW	KBA40ED4305TW	KBB25ED42305TW	KBB40ED42305TW
			2	3	KBA25ED4303TW	KBA40ED4303TW	-	-
 KBB••ED••~••TW					KBA40ED4203TW	KBA40ED4203TW	KBB40ED42203TW	KBB40ED42203TW



AB - Feed units

		Mounting	Terminals (mm ²)	Cable gland max Ø (mm)	Catalogue numbers Order in multiples of 1			
 KBA40ABG4TW KBB40ABG44TW		Left	10	PG21 Ø19	KBA40ABG4TW	KBA40ABG4TW	KBB40ABG44TW	KBB40ABG44TW
		Right	10	PG21 Ø19	KBA40ABD4TW	KBA40ABD4TW	KBB40ABD44TW	KBB40ABD44TW
 KBA40ABT4TW		Central	10	PG21 Ø19	KBA40ABT4TW	KBA40ABT4TW	KBB40ABT44TW	KBB40ABT44TW
 KBB40ABT44TW								

DF - Flexibles

		Type of component	Length (m)	Catalogue numbers Order in multiples of 1			
 KBA40DF405TW	Flexible		0.5	KBA40DF405TW	KBA40DF405TW	KBB40DF4405TW	KBB40DF4405TW
			2	KBA40DF420TW	KBA40DF420TW	KBB40DF4420TW	KBB40DF4420TW
 KBA40DF420TW							
 KBB40DF4405TW							
 KBB40DF4420TW							

ZF - Fixing brackets

		Type of component	Mounting	Catalogue numbers Order in multiples of 10			
 KBA40ZFU KBB40ZFU		Universal fixing bracket	Suspended on threaded rod or lateral (except wall)	KBA40ZFU	KBA40ZFU	KBB40ZFU	KBB40ZFU
		Cable suspension system	With 3m steel cable	KBA40ZFSU	KBA40ZFSU	KBB40ZFSU	KBB40ZFSU
 KBA40ZFSU KBB40ZFSU							

Connectors for combined **DALI** and **KNX** protocols

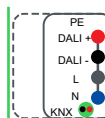



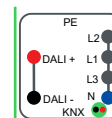

25 or 40 A



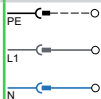

25 or 40 A

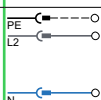
▲ Connector mounting side

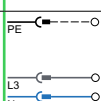

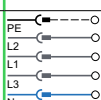

DCS - 16 A - Connectors direct pre-wired - 1 m

	Polarity	Scheme	Color	Catalogue numbers Order in multiples of 10
 KBC16DCS101T	L1 + N DALI +/- KNX +/-		Green	- KBC16DCS101T
 KBC16DCS201T	L2 + N DALI +/- KNX +/-		Yellow	- KBC16DCS201T
 KBC16DCS301T	L3 + N DALI +/- KNX +/-		Brown	- KBC16DCS301T

DCB - 16 A - Connectors direct not wired - With phase selection

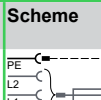
 KBC16DCB21	L1 + N or L2 + N or L3 + N DALI +/- KNX +/-		-	- KBC16DCB21 + KBC16ZT1
 KBC16DCB40	3L + N DALI +/- KNX +/-		-	KBC16DCB40 + KBC16ZT1 KBC16DCB40 + KBC16ZT1
 KBC16DCB22	L1 + L2 or L1 + L3 or L2 + L3 DALI +/- KNX +/-		-	- KBC16DCB22 + KBC16ZT1

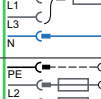
DCF - 16 A - Connectors for fuses not wired - With phase selection

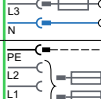
	Polarity	Scheme	Protection	Catalogue numbers Order in multiples of 10
 KBC16DCF21	L1 + N or L2 + N or L3 + N DALI +/- KNX +/-		Cylindrical fuse NF 8.5 x 31.5 mm	- KBC16DCF21 + KBC16ZT1
 KBC16DCF40	3L + N DALI +/- KNX +/-		Cylindrical fuse NF 8.5 x 31.5 mm	KBC16DCF40 + KBC16ZT1 KBC16DCF40 + KBC16ZT1
 KBC16DCF22	L1 + L2 or L1 + L3 or L2 + L3 DALI +/- KNX +/-		Cylindrical fuse NF 8.5 x 31.5 mm	- KBC16DCF22 + KBC16ZT1

DCP - 16 A - Connectors for fuses with power sockets not wired - With phase selection

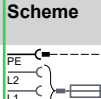
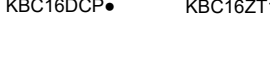
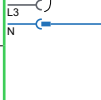
 KBC16DCP1	L1 + N or L2 + N or L3 + N DALI +/- KNX +/-		NF 2P+T 10/16 A, 250 V	- KBC16DCP1 + KBC16ZT1
 KBC16DCP2	L1 + N or L2 + N or L3 + N DALI +/- KNX +/-		VDE 2P+T 10/16 A, 250 V	- KBC16DCP2 + KBC16ZT1



Control system

Line components for **KNX** alone or others protocols

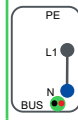

25 A

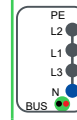

40 A





25 A

40 A



ED - Straight lengths

	Length (m)	Distance between outlets (m)	Number of outlets	Catalogue numbers Order in multiples of 6			
 KBA●●ED●●●●TW	3	0.5	5	KBA25ED2305TW	KBA40ED2305TW	KBA25ED4305TW	KBA40ED4305TW
		1	3	KBA25ED2303TW	KBA40ED2303TW	KBA25ED4303TW	KBA40ED4303TW
 KBB●●ED●●●●●●TW	2	1	3	KBA40ED2203TW	KBA40ED2203TW	KBA40ED4203TW	KBA40ED4203TW



AB - Feed units

	Mounting	Terminals (mm ²)	Cable gland max Ø (mm)	Catalogue numbers Order in multiples of 1			
 KBA40ABG4TW KBB40ABG44TW	Left	10	PG21 Ø19	KBA40ABG4TW	KBA40ABG4TW	KBA40ABG4TW	KBA40ABG4TW
 KBA40ABD4TW KBB40ABD44TW	Right	10	PG21 Ø19	KBA40ABD4TW	KBA40ABD4TW	KBA40ABD4TW	KBA40ABD4TW
 KBA40ABT4TW KBB40ABT44TW	Central	10	PG21 Ø19	KBA40ABT4TW	KBA40ABT4TW	KBA40ABT4TW	KBA40ABT4TW

DF - Flexibles

	Type of component	Length (m)	Catalogue numbers Order in multiples of 1			
 KBA40DF405TW KBA40DF420TW	Flexible	0.5	KBA40DF405TW	KBA40DF405TW	KBA40DF405TW	KBA40DF405TW
		2	KBA40DF420TW	KBA40DF420TW	KBA40DF420TW	KBA40DF420TW
 KBB40DF4405TW KBB40DF4420TW						

ZF - Fixing brackets

	Type of component	Mounting	Catalogue numbers Order in multiples of 10			
 KBA40ZFU KBB40ZFU	Universal fixing bracket	Suspended on threaded rod or lateral (except wall)	KBA40ZFU	KBA40ZFU	KBA40ZFU	KBA40ZFU
 KBA40ZFSU KBB40ZFSU	Cable suspension system	With 3m steel cable	KBA40ZFSU	KBA40ZFSU	KBA40ZFSU	KBA40ZFSU

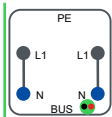

25 A

40 A

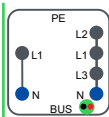

25 A

40 A

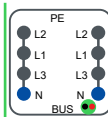

25 A

40 A

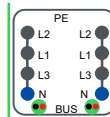

40 A

Catalogue numbers
Order in multiples of 6

KBB25ED22305TW	KBB40ED22305TW	KBB25ED42305TW	KBB40ED42305TW	KBB25ED44305TW	KBB40ED44305TW	KBB40ED44305T2W
----------------	----------------	----------------	----------------	----------------	----------------	-----------------

-	-	-	-	-	-	-
---	---	---	---	---	---	---

KBB40ED22203TW	KBB40ED22203TW	KBB40ED42203TW	KBB40ED42203TW	KBB40ED44203TW	KBB40ED44203TW	-
----------------	----------------	----------------	----------------	----------------	----------------	---

Catalogue numbers
Order in multiples of 1

KBB40ABG44TW	KBB40ABG44TW	KBB40ABG44TW	KBB40ABG44TW	KBB40ABG44TW	KBB40ABG44TW	KBB40ABG44T2W
--------------	--------------	--------------	--------------	--------------	--------------	---------------

KBB40ABD44TW	KBB40ABD44TW	KBB40ABD44TW	KBB40ABD44TW	KBB40ABD44TW	KBB40ABD44TW	-
--------------	--------------	--------------	--------------	--------------	--------------	---

KBB40ABT44TW	KBB40ABT44TW	KBB40ABT44TW	KBB40ABT44TW	KBB40ABT44TW	KBB40ABT44TW	KBB40ABT44TW
--------------	--------------	--------------	--------------	--------------	--------------	--------------

Catalogue numbers
Order in multiples of 1

KBB40DF4405TW	KBB40DF4405TW	KBB40DF4405TW	KBB40DF4405TW	KBB40DF4405TW	KBB40DF4405TW	-
---------------	---------------	---------------	---------------	---------------	---------------	---

KBB40DF4420TW	KBB40DF4420TW	KBB40DF4420TW	KBB40DF4420TW	KBB40DF4420TW	KBB40DF4420TW	-
---------------	---------------	---------------	---------------	---------------	---------------	---

Catalogue numbers
Order in multiples of 10

KBB40ZFU	KBB40ZFU	KBB40ZFU	KBB40ZFU	KBB40ZFU	KBB40ZFU	KBB40ZFU
----------	----------	----------	----------	----------	----------	----------

KBB40ZFSU	KBB40ZFSU	KBB40ZFSU	KBB40ZFSU	KBB40ZFSU	KBB40ZFSU	KBB40ZFSU
-----------	-----------	-----------	-----------	-----------	-----------	-----------



Control system

Connectors for **KNX** alone or others protocols

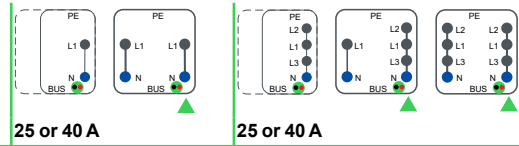

▲ Connector mounting side

DCS - 16 A - Connectors direct pre-wired - 1 m					
	Polarity	Scheme	Color	Catalogue numbers Order in multiples of 10	
 KBC16DCS101T	L1 + N BUS +/-		Green	KBC16DCS101T	KBC16DCS101T
 KBC16DCS201T	L2 + N BUS +/-		Yellow	-	KBC16DCS201T
 KBC16DCS301T	L3 + N BUS +/-		Brown	-	KBC16DCS301T
DCB - 16 A - Connectors direct not wired					
 KBC16DCB21	L1 + N or L2 + N or L3 + N BUS +/-		-	KBC16DCB21 + KBC16ZT1	KBC16DCB21 + KBC16ZT1
 KBC16DCB40	3L + N BUS +/-		-	-	KBC16DCB40 + KBC16ZT1
 KBC16DCB22	L1 + L2 or L1 + L3 or L2 + L3 BUS +/-		-	-	KBC16DCB22 + KBC16ZT1
DCF - 16 A - Connectors for fuses not wired					
	Polarity	Scheme	Protection	Catalogue numbers Order in multiples of 10	
 KBC16DCF21	L1 + N or L2 + N or L3 + N BUS +/-		Cylindrical fuse NF 8.5 x 31.5 mm	KBC16DCF21 + KBC16ZT1	KBC16DCF21 + KBC16ZT1
 KBC16DCF40	3L + N BUS +/-		Cylindrical fuse NF 8.5 x 31.5 mm	-	KBC16DCF40 + KBC16ZT1
 KBC16DCF22	L1 + L2 or L1 + L3 or L2 + L3 BUS +/-		Cylindrical fuse NF 8.5 x 31.5 mm	-	KBC16DCF22 + KBC16ZT1
DCP - 16 A - Connectors for fuses with power sockets not wired					
	Polarity	Scheme	Protection	Catalogue numbers Order in multiples of 1	
 KBC16DCP1	L1 + N or L2 + N or L3 + N BUS +/-		NF 2P+T 10/16 A, 250 V	KBC16DCP1 + KBC16ZT1	KBC16DCP1 + KBC16ZT1
 KBC16DCP2	L1 + N or L2 + N or L3 + N BUS +/-		VDE 2P+T 10/16 A, 250 V	KBC16DCP2 + KBC16ZT1	KBC16DCP2 + KBC16ZT1































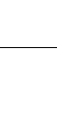

All versions

Fixing brackets

KBA

KBB







ZF - Fixing brackets		Type of component	Mounting	Order in multiples of	Catalogue numbers		
		Universal fixing bracket	Suspended on threaded rod or lateral (except wall)	10	KBA40ZFU	KBB40ZFU	
KBA40ZFU	KBB40ZFU	Cable suspension system	With steel cable	10	KBA40ZFSU	KBB40ZFSU	
			For steel cable	10	KBA40ZFSL	KBB40ZFSL	
			3 m steel cable alone	10	KBB40ZFS23	KBB40ZFS23	
KB40ZFSU	KBB40ZFSU	Double universal fixing bracket	For pigtail or open hook to suspend the luminaire	1	KBA40ZFU2W	KBB40ZFU2W	
			Spring fixing bracket	Adjustable for threaded rod, M6	10	KBB40ZFPU	KBB40ZFPU
				Pigtail hook	Suspended by small chain	10	KBB40ZFC
		Raiser		For mounting on wall or false floor	10	KBB40ZFMP	KBB40ZFMP
KBA40ZFU2W	KBB40ZFU2W	Open hook	To suspend the luminaire	10	KBB40ZFC5	KBB40ZFC5	
		Ring	Mounted on the luminaire	10	KBB40ZFC6	KBB40ZFC6	
KBB40ZFPU	KBB40ZFC	Fixing bracket	For direct suspension of luminaires on KBB	12	-	KBB40ZFL	
							
KBB40ZFC5	KBB40ZFC6						
							
KBB40ZFL	KBB40ZFL						
							
KBB40ZFC	KBB40ZFC						
							
KBB40ZFC5	KBB40ZFC5						
							
KBB40ZFC6	KBB40ZFC6						
							
KBB40ZFL	KBB40ZFL						

Cable duct support		Type of component	Mounting	Order in multiples of	Catalogue numbers	
		Cable duct	Width 25 mm, length 3 m	6	KFB25CD253	KFB25CD253
KFB25CD253		Cable duct support	To be mounted on a spring fixing bracket (1)	10	KBB40ZFG1	KBB40ZFG1
						
KBB40ZFG1		Cable duct support + intermediate support (2)		10	KBA40ZFG2	KBB40ZFG2
						
KBA40ZFG2	KBB40ZFG2	Cable bracket	For adjacent circuits	20	KBB40ZFGU	KBB40ZFGU
						
KBB40ZFGU	KBB40ZFGU					

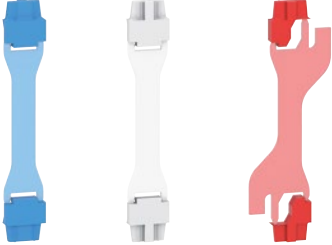
(1) Maximum recommended distance between fixings: 2 meters.
 (2) Maximum recommended distance between fixings: 3 meters.

KBA

KBB

Other accessories		Type of component	Mounting	Color	Order in multiples of	Catalogue numbers	
 KBC16ZL10 KBC16ZL20 KBC16ZL30	Outlet/connector unit interlocking device (2 parts)	Identification and mechanical interlocking between 1 to 3 different circuits		Blue	20	KBC16ZL10	KBC16ZL10
				White	20	KBC16ZL20	KBC16ZL20
				Red	20	KBC16ZL30	KBC16ZL30
 KBC16ZT1	Bus connection device	For 16 A single-phase or three-phase connector to connect the remote control circuit of the trunking to the remote receiver			10	KBC16ZT1	KBC16ZT1
 KBC16ZB1	Blanking plate	Restore IP55 on connector outlet if original blanking plate is lost			10	KBC16ZB1	KBC16ZB1
 KBC16ZC1	Rear support bracket	For securing 16 A single-phase connector to the trunking			10	KBC16ZC1	KBC16ZC1
 KBA40AF KBB40AF	End cover	Spare part			5	KBA40AF	-
					10		KBB40AF
 KB•40EDA20W	Empty length	Used to adjust line length to building dimensions. Two metres long, can be cut on site.			1	KBA40EDA20W	KBB40EDA20W



Components and fixations

Canalis KBA

ED - Straight lengths

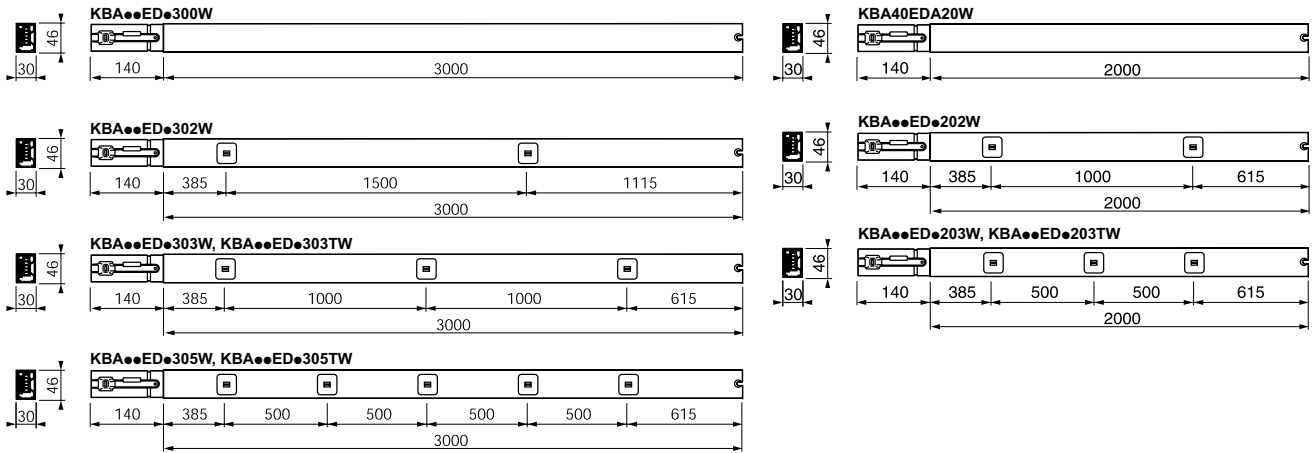

AB - Feed units

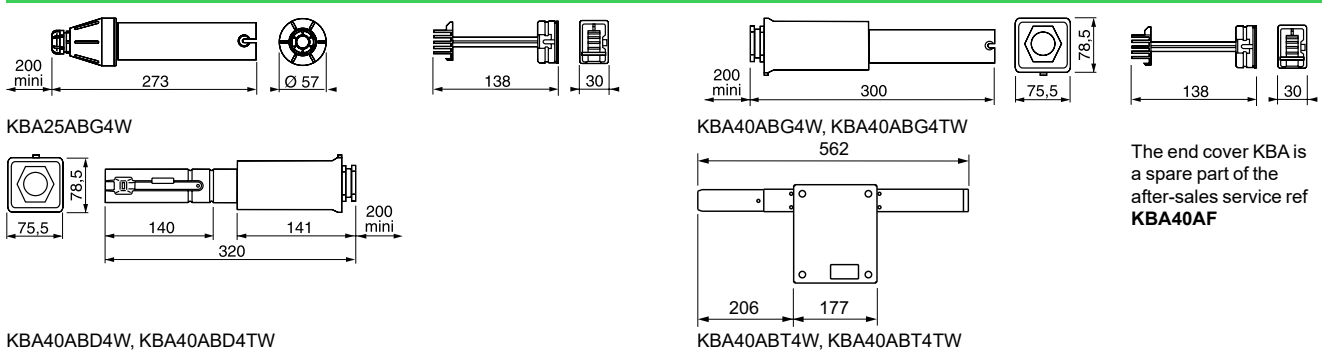

DF - Flexibles

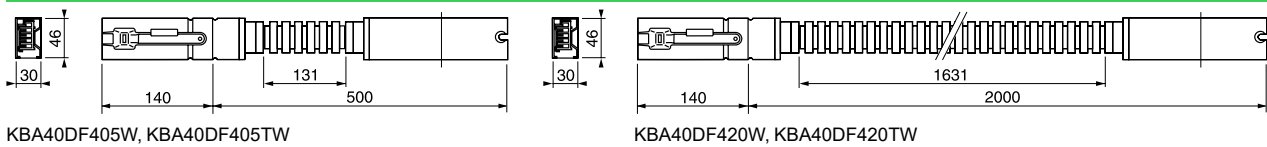

ZF - Fixing brackets

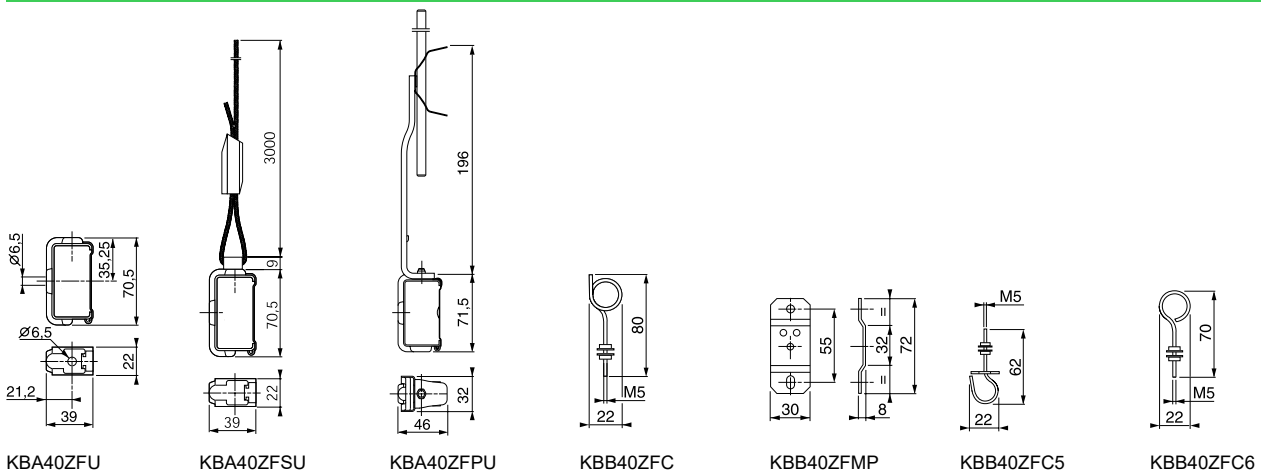

Components and fixations

Canalis KBC

DC - Connectors

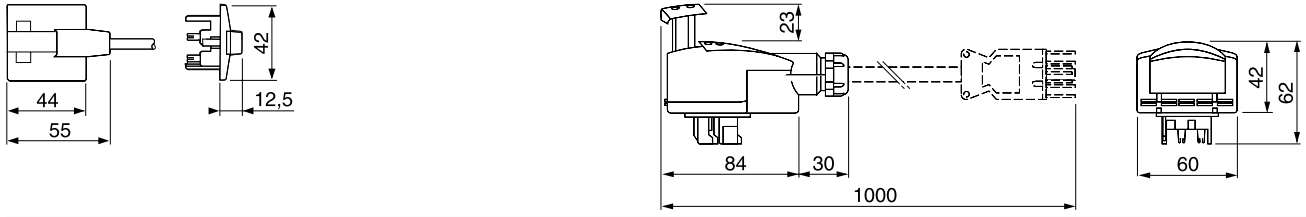

KBC10DCS101, KBC10DCS201, KBC10DCS301
KBC10DCS101T, KBC10DCS201T, KBC10DCS301T

KBC10DCC211, KBC10DCB20, KBC10DCB40

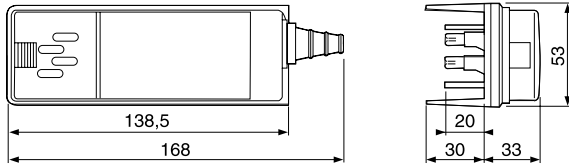

KBC16DCB21, KBC16DCB22, KBC16DCB216, KBC16DCB226, KBC16DCF21, KBC16DCF22, KBC16DCF216, KBC16DCF226

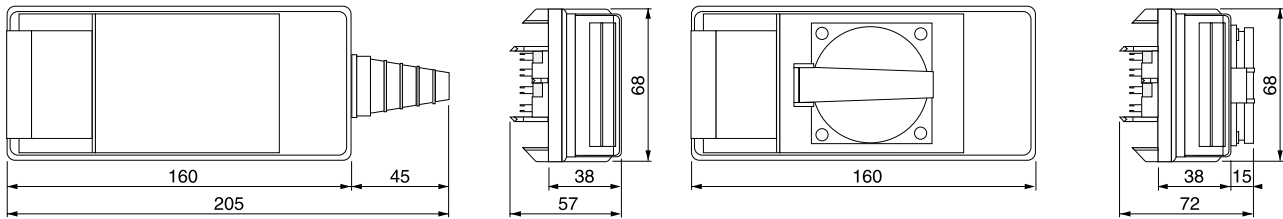

KBC16DCB40, KBC16DCF40,

KBC16DCP1, KBC16DCP2

Accessories

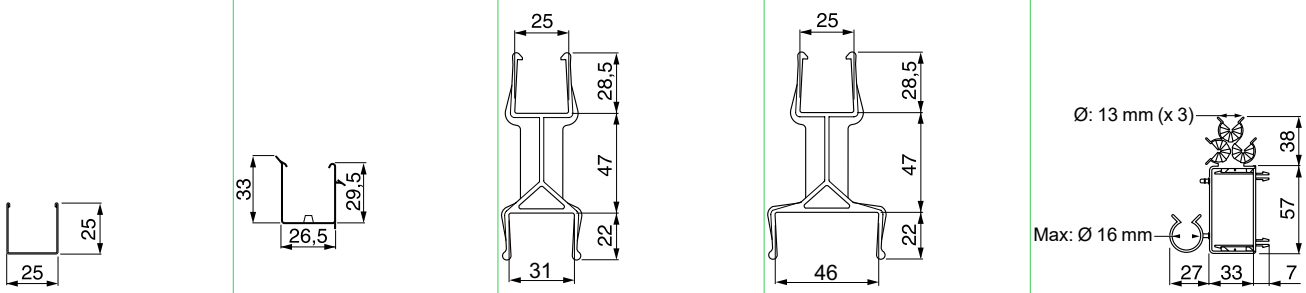

KFB25CD253

KBB40ZFG1

KBA40ZFG2

KBB40ZFG2

KBB40ZFGU



LRV 10017

LRV 10020

LRV 10020

LRV 10023



Characteristics

Canalis KBA

Run component characteristics								
Rating of trunking (A)			25	40				
General characteristics								
Compliance with standards			IEC/EN 61439-6		IEC/EN 61439-6			
Degree of protection	IP		55		55			
Mechanical impacts	IK		06		06			
Color			RAL 9003 white		RAL 9003 white			
Polarity								
Number of live conductors			2 or 4		2 or 4			
Rated current at an ambient temperature of 35°C	I_{nc}	A	25		40			
Rated insulation voltage	U_i	V	690		690			
Rated operational voltage	U_e	V	230...400		230...400			
Rated impulse voltage	U_{imp}	kV	4		4			
Rated frequency	f	Hz	50/60		50/60			
Conductor characteristics								
Phase conductors								
Mean resistance at an ambient temperature of 20°C	R_{20}	mΩ/m	6.80		2.83			
Mean resistance at I_{nc} and 35°C	R_1	mΩ/m	8.30		3.46			
Mean reactance at I_{nc} , 35°C and 50 Hz	X_1	mΩ/m	0.02		0.02			
Mean impedance at I_{nc} , 35°C and 50 Hz	Z_1	mΩ/m	8.33		3.46			
Protective conductor (PE)								
Mean resistance at an ambient temperature of 20°C		mΩ/m	1.57		1.57			
Fault loop characteristics								
Symmetrical components method	Ph/N at 20°C	Mean resistance	$R_{0\ ph/N}$	mΩ/m	27.21			
		Mean reactance	$X_{0\ ph/N}$	mΩ/m	0.85			
		Mean impedance	$Z_{0\ ph/N}$	mΩ/m	27.22			
	Ph/PE at 20°C	Mean resistance	$R_{0\ ph/PE}$	mΩ/m	19.40			
		Mean reactance	$X_{0\ ph/PE}$	mΩ/m	0.38			
		Mean impedance	$Z_{0\ ph/PE}$	mΩ/m	19.41			
Impedance method	At 20°C	Mean resistance	Ph/Ph	$R_{b0\ ph/ph}$	mΩ/m	13.61		
			Ph/N	$R_{b0\ ph/N}$	mΩ/m	13.61		
			Ph/PE	$R_{b0\ ph/PE}$	mΩ/m	11.01		
		For I_{nc} at 35°C	Mean resistance	Ph/Ph	$R_{b1\ ph/ph}$	mΩ/m	16.60	
				Ph/N	$R_{b1\ ph/N}$	mΩ/m	16.60	
				Ph/PE	$R_{b1\ ph/PE}$	mΩ/m	12.50	
	For I_{nc} at 35°C and 50 Hz	Mean reactance	Ph/Ph	$X_{b\ ph/ph}$	mΩ/m	0.04		
			Ph/N	$X_{b\ ph/N}$	mΩ/m	0.04		
			Ph/PE	$X_{b\ ph/PE}$	mΩ/m	0.035		
	Other characteristics							
	Short-circuit withstand capacity							
	Rated peak withstand current	I_{pk}	kA	4.40		9.60		
Maximum thermal limit I^2t		A²s	195 x 10 ³		900 x 10 ³			
Rated short-time withstand current (t = 1 s)	I_{cw}	kA	0.44		0.94			
Voltage drop								
			Composite voltage drop (hot state) expressed in V/100 mA (50 Hz) with the load uniformly distributed over the run. If the load is concentrated at one end of the run, the voltage drop is twice the value indicated in the table.					
For a power factor of	1	V/100 mA	0.72		0.30			
	0.9	V/100 mA	0.67		0.28			
	0.8	V/100 mA	0.61		0.25			
	0.7	V/100 mA	0.54		0.22			
	This table is given for three-phases network. The single phase voltage drop is obtained by dividing the three-phase voltage drop indicated above by 0.866. For lower neutral / neutral voltage phase, we divide the voltage drop above by 1.732.							
Radiated magnetic field								
Radiated magnetic field strength 1 metre from the trunking	B	μT	< 2 x 10 ⁻³		< 2 x 10 ⁻³			
Derating in case of harmonics								
Operational current as a function of 3rd harmonic content	THD ≤ 15 %		25		40			
	15 % < THD ≤ 33 %		20		32			
	THD > 33 %		16		28			
Permissible current as a function of ambient temperature								
Ambient temperature	°C	< 35	35	40	45	50		
Coefficient K1	%	n/a	1	0.96	0.93	0.89		

Run component characteristics				25			40				
Rating of trunking (A)				25			40				
General characteristics											
Compliance with standards				IEC/EN 61439-6			IEC/EN 61439-6				
Degree of protection		IP		55			55				
Mechanical impacts		IK		06			06				
Color				RAL 9003 white			RAL 9003 white				
Polarity											
				If polarity			L1 N L2 N Consult us				
Number of circuits				1			2				
Rated current at an ambient temperature of 35°C		I _{nc}		A		25		23			
Rated insulation voltage		U _i		V		690		690			
Rated operational voltage		U _e		V		230...400		230...400			
Rated impulse voltage		U _{imp}		kV		4		4			
Rated frequency		f		Hz		50/60		50/60			
Conductor characteristics											
Phase conductors											
Mean resistance at an ambient temperature of 20°C		R ₂₀		mΩ/m		6.80		2.83			
Mean resistance at I _{nc} and 35°C		R ₁		mΩ/m		8.30		3.46			
Mean reactance at I _{nc} , 35°C and 50 Hz		X ₁		mΩ/m		0.02		0.02			
Mean impedance at I _{nc} , 35°C and 50 Hz		Z ₁		mΩ/m		8.33		3.46			
Protective conductor (PE)											
Mean resistance at an ambient temperature of 20°C				mΩ/m		0.80		0.80			
Fault loop characteristics											
Symmetrical components method	Ph/N at 20°C	Mean resistance	R _{0 ph/N}	mΩ/m	27.21	17.28					
		Mean reactance	X _{0 ph/N}	mΩ/m	0.85	5.25					
		Mean impedance	Z _{0 ph/N}	mΩ/m	27.22	18.06					
Ph/PE at 20°C	Mean resistance	R _{0 ph/PE}	mΩ/m	17.28	13.83						
	Mean reactance	X _{0 ph/PE}	mΩ/m	5.25	0.73						
	Mean impedance	Z _{0 ph/PE}	mΩ/m	18.06	13.85						
Impedance method	At 20°C	Mean resistance	Ph/Ph	R _{b0 ph/ph}	mΩ/m	13.61	5.68				
			Ph/N	R _{b0 ph/N}	mΩ/m	13.61	5.68				
			Ph/PE	R _{b0 ph/PE}	mΩ/m	10.26	6.92				
	For I _{nc} at 35°C	Mean resistance	Ph/Ph	R _{b1 ph/ph}	mΩ/m	16.59	6.92				
			Ph/N	R _{b1 ph/N}	mΩ/m	16.59	6.92				
			Ph/PE	R _{b1 ph/PE}	mΩ/m	11.77	7.14				
	For I _{nc} at 35°C and 50 Hz	Mean reactance	Ph/Ph	X _{b ph/ph}	mΩ/m	0.35	0.90				
			Ph/N	X _{b ph/N}	mΩ/m	0.35	0.90				
			Ph/PE	X _{b ph/PE}	mΩ/m	0.07	1.85				
	Other characteristics										
	Short-circuit withstand capacity										
	Rated peak withstand current		I _{pk}		kA		4.40		9.60		
Maximum thermal limit I ² t				A ² s		195 x 10 ³		900 x 10 ³			
Rated short-time withstand current (t = 1 s)		I _{cw}		kA		0.44		0.94			
Voltage drop											
				Composite voltage drop (hot state) expressed in V/100 mA (50 Hz) with the load uniformly distributed over the run. If the load is concentrated at one end of the run, the voltage drop is twice the value indicated in the table.							
For a power factor of				1		V/100 mA		0.72		0.30	
				0.9		V/100 mA		0.67		0.28	
				0.8		V/100 mA		0.61		0.25	
				0.7		V/100 mA		0.55		0.22	
				This table is given for three-phases network. The single phase voltage drop is obtained by dividing the three-phase voltage drop indicated above by 0.866. For lower neutral / neutral voltage phase, we divide the voltage drop above by 1.732.							
Radiated magnetic field											
Radiated magnetic field strength 1 metre from the trunking		B		μT		< 2 x 10 ⁻³		< 2 x 10 ⁻³			
Derating in case of harmonics											
Operational current as a function of 3 rd harmonic content		THD ≤ 15 %				25		40			
		15 % < THD ≤ 33 %				20		32			
		THD > 33 %				16		28			
Permissible current as a function of ambient temperature											
Ambient temperature		°C		< 35		35		40		45	
Coefficient K1		%		n/a		1		0.96		0.93	
										50	
										0.89	
										55	
										0.85	

Connector characteristics

Type of connector	KBC10	KBC10 Lighting control	KBC16CB	KBC16CF
-------------------	-------	------------------------------	---------	---------

General characteristics

Compliance with standards		IEC/EN 61439-6			
Degree of protection	IP	55	55	55	55
Rated current at an ambient temperature of 35°C	I _{nc} A	10	10	16	16
Rated insulation voltage	U _i V	690	400	690	400
Rated operational voltage	U _e V	230...400	230...400	230...400	230...400

Bus characteristics

		DALI	KNX
Cross-section and type of conductor	mm ²	2 x 2.5 copper	2 x 0.5 copper
Rated insulation voltage (U _i) (between power circuit and bus)	V	690	500
Rated operational voltage (U _e) (max. U between bus + and - poles)	V	230 to 400	32
Maximum operational current (I _e)	A	25	3.8
Linear resistance	mΩ/m	52	75
Linear capacitance	pF/m	30	100
Maximum recommended length	m	300	300

Voltage drop in the Canalis busbar trunking

The table below indicates the three-phase voltage drop, in volts, in the Canalis busbar trunking (electrical power uniformly distributed). The single-phase voltage drop is obtained by dividing the three-phase voltage drop indicated below by 0.866. If the exact operational current (I_b) and length are not available, select the next highest.

Type of Canalis	Operational current (A)	Length of line (m)															
		6	8	10	12	15	20	25	30	35	40	45	50	60	70	80	100
25 A KBA 25 A KBB cos 0.8	10	0.4	0.5	0.6	0.7	0.9	1.2	1.5	1.8	2.1	2.4	2.8	3.1	3.7	4.3	4.9	6.1
	16	0.6	0.8	1	1.2	1.5	2	2.4	2.9	3.4	3.9	4.4	4.9	5.9	6.8	7.8	9.8
	20	0.7	1	1.3	1.5	1.8	2.4	3.1	3.7	4.3	4.9	5.5	6.1	7.3	8.6	9.8	12.2
	25	0.9	1.2	1.5	1.8	2.3	3.1	3.8	4.6	5.3	6.1	6.9	7.6	9.2	10.7	12.2	15.3
25 A KBA 25 A KBB cos 0.9	10	0.4	0.5	0.7	0.8	1	1.3	1.7	2	2.3	2.7	3	3.4	4	4.7	5.4	6.7
	16	0.6	0.9	1.1	1.3	1.6	2.1	2.7	3.2	3.8	4.3	4.8	5.4	6.4	7.5	8.6	10.7
	20	0.8	1.1	1.3	1.6	2	2.7	3.4	4	4.7	5.4	6	6.7	8	9.4	10.7	13.4
	25	1	1.3	1.7	2	2.5	3.4	4.2	5	5.9	6.7	7.5	8.4	10.1	11.7	13.4	16.8
25 A KBA 25 A KBB cos 1	10	0.4	0.6	0.7	0.9	1.1	1.4	1.8	2.2	2.5	2.9	3.2	3.6	4.3	5	5.8	7.2
	16	0.7	0.9	1.2	1.4	1.7	2.3	2.9	3.5	4	4.6	5.2	5.8	6.9	8.1	9.2	11.5
	20	0.9	1.2	1.4	1.7	2.2	2.9	3.6	4.3	5	5.8	6.5	7.2	8.6	10.1	11.5	14.4
	25	1.1	1.4	1.8	2.2	2.7	3.6	5.4	5.4	6.3	7.2	8.1	9	41.8	12.6	14.4	18
40 A KBA 40 A KBB cos 0.8	16	0.2	0.3	0.4	0.5	0.6	0.8	1	1.2	1.4	1.6	1.8	2	2.4	2.8	3.2	4
	20	0.3	0.4	0.5	0.6	0.7	1	1.2	1.5	1.7	2	2.2	2.5	3	3.5	4	5
	25	0.4	0.5	0.6	0.7	0.9	1.2	1.6	1.9	2.2	2.5	2.8	3.1	3.7	4.4	5	6.2
	32	0.5	0.6	0.8	1	1.2	1.6	2	2.4	2.8	3.2	3.6	4	4.8	5.6	6.4	8
40 A KBA 40 A KBB cos 0.9	16	0.3	0.4	0.4	0.5	0.7	0.9	1.1	1.3	1.6	1.8	2	2.2	2.7	3.1	3.6	4.5
	20	0.3	0.4	0.6	0.7	0.8	1.1	1.4	1.7	2	2.2	2.5	2.8	3.4	3.9	4.5	5.6
	25	0.4	0.6	0.7	0.8	1.1	1.4	1.8	2.1	2.5	2.8	3.2	3.5	4.2	4.9	5.6	7
	32	0.5	0.7	0.9	1.1	1.3	1.8	2.2	2.7	3.1	3.6	4	4.5	5.4	6.3	7.2	9
40 A KBA 40 A KBB cos 1	16	0.3	0.4	0.5	0.6	0.7	1	1.2	1.4	1.7	1.9	2.2	2.4	2.9	3.4	3.8	4.8
	20	0.4	0.5	0.6	0.7	0.9	1.2	1.5	1.8	2.1	2.4	2.7	3	3.6	4.2	4.8	6
	25	0.5	0.6	0.8	0.9	1.1	1.5	1.9	2.3	2.6	3	3.4	3.8	4.5	5.3	6	7.5
	32	0.6	0.8	1	1.2	1.4	1.9	2.4	2.9	3.4	3.8	4.3	3.8	5.8	6.7	7.7	9.6
40	0.7	1	1.2	1.4	1.8	2.4	3	3.6	4.2	4.8	5.4	6	7.2	8.4	9.6	12	

Voltage-drop conversion

Operational voltage (V)	Voltage drop in volts for a given %															
	0.3	0.5	1	1.5	2	2.5	3	3.5	4	4.5	5	6	7	8	9	10
230	0.7	1.2	2.3	3.5	4.6	5.8	6.9	8.1	9.2	10	12	14	16	18	21	23
400	1.2	2	4	6	8	10	12	14	16	18	20	24	28	32	36	40

Procedure to select Canalis KB

1. Identify the external influences

The ambient temperature, presence of dust, condensation of water, etc. contribute to the definition of the degree of protection required in the area where the lines will be installed.

Canalis KB has a degree of protection IP55 and is sprinkler resistant. It has a mechanical resistance IK06. As per the requirement of the IEC 61439-6 the operating ratings are given for an ambient temperature of 35°C.

2. Identify the determinant data

L = Length of the line (m)

D = Distance between each lightings (m)

P = Power of lightings (W)

F = Power factor of lightings (Cos φ)

W = Weight of lighting (kg)

N = Number of lightings per line

V = Voltage (Volt)

3. Determine the maximum current carrier by the busbartrunking in operation

N = Number of lightings per line = (L/D) - 1

Max current = $N \times P / F / V$

Example:

L = 95 m

D = 3 m

P = 80 W

F = 0.8

V = 230 Volt (L+N)

$N = (95/3) - 1 = 31 - 1 = 30$

Max current = $30 \times 80 / 0.8 / 230 = 13.04 \text{ A}$

The just above available rating is 25 A.

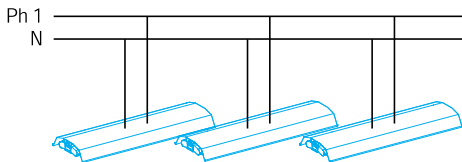

Ph + N distribution

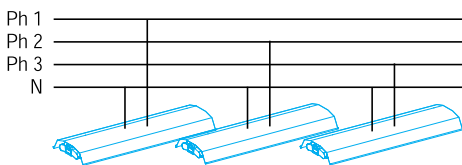

3Ph + N balanced distribution

4. Check if the voltage drop is below 3 %

Use data pages 44 and 45 to determine the characteristics of Canalis KBA 25 A and Canalis KBB 25 A.

Canalis KBA 25 A:

Voltage drop per 100 m / A for a power factor 0.8 = 0.61

Voltage for 95 m: $0.61 \times 13.04 \times 0.95 = 7.55 \text{ V}$

Voltage drop in %: $7.55 / 230 = 3.2 \%$

The voltage drop is too high, the line length need to be reduced or a superior rating need to be selected.

Examples of calculation are available page 46.

5. Select the adapted overload and short-circuit protection

See page 48 to page 51.

6. Selected the most adapted product to support the lighting weight

See page 52.

Select the overload protection

Precalculating XLPE or PVC cables + Canalis

Drawn from the Ecodial low-voltage installation-calculation software, the information provided here assists in defining busbar trunking (cables and Canalis) and their protection in compliance with installation standards and calculation guide.

Protection of the main busbar trunking (cable + Canalis)

- The tables below may be used to determine:
 - the rated current (In) or the setting current (Ir) of the overload-protection devices,
 - the rated current (Inc) of Canalis,
 - the thermal minimum cross-section of cables.
- These three characteristics are defined for the following installation conditions:
 - maximum ambient temperature 30°C,
 - cables placed in cable trays. Layout as a single horizontal layer or in groups of 2 or 3 cores.

Connector protection

Canalis connectors must have overload protection. The connector is created using a fused connector unit to protect the cable (C₃) and the device against short-circuits.

This protection offers good discrimination during operation (continuity of service, trouble-shooting, etc.).

For lighting, it may be useful to take advantage of the **possibilities for dispensing with or remotely locating** the protection, offered by standard IEC 60364-4-43 (§ 433 and 434) and summarised in the texts below, drawn from UTE C 15-107.

The connector is created using a pre-wired connector unit.

Supply to devices not subject to overloads

Exemption possibilities:

- the C₃ cable (connection to the device) does not need to be protected against overloads (NF C 15-100, 473.1.2b) or short-circuits (NF C 15-100, 473.2.2.1) because the cable:
 - is not subject to overload currents,
 - does not have connectors or power sockets,
 - is less than or equal to three metres,
 - is designed to reduce to a minimum the risk of short-circuits,
 - is not located near any flammable material.



Example: luminaires, convectors, etc.

Supply to devices with built-in overload protection

Exemption possibilities:

- the device P₂ protecting C₃ cable against overloads is not positioned at the head (NF C 15-100, 473.1.1.2 b) of C₃ because the latter:
 - does not have connectors or power sockets,
 - is less than or equal to three metres,
 - is designed to reduce to a minimum the risk of short-circuits,
 - is not located near any flammable material.

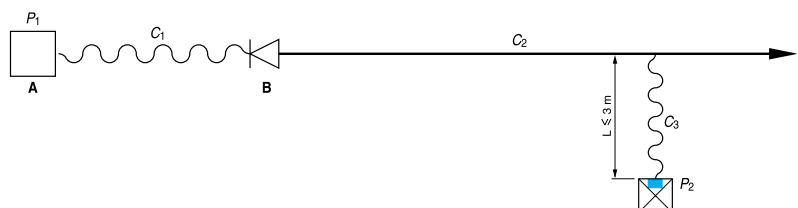

NB: P₁ - P₂ are short-circuit protection devices.

Select the overload protection

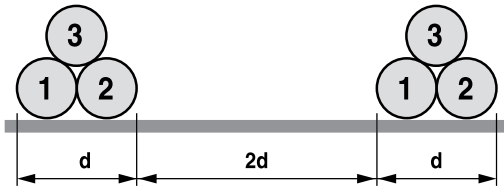

Cables spaced in cable trays.

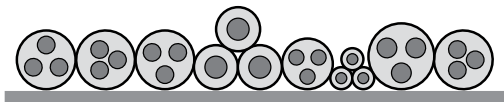

Cables touching in cable trays.

Precalculating XLPE or PVC cables + Canalis

The tables below determine, as a function of the type of overload protection (circuit breaker or fuse):

- the type of busbar trunking required
- the size of supply cables (in mm²) as a function of the installation method, for all conductor configurations.

Protection by iC60 (curve C) modular circuit breaker								
Type of busbar trunking	Operat. current Circuit-breaker rating (A)	XLPE cable			PVC cable			
		Spaced	Touching (number of cables)		Spaced	Touching (number of cables)		
			2 to 5	6 or more		2	3	4 or more
25 A KBA	10	1.5	1.5	1.5	1.5	1.5	1.5	1.5
25 A KBB	16	1.5	1.5	1.5	1.5	2.5	2.5	2.5
	20	1.5	2.5	2.5	2.5	2.5	4	4
25 A KBA 25 A KBB	25	2.5	4	4	2.5	4	4	6
			2.5 ⁽¹⁾	2.5 ⁽¹⁾				
40 A KBA 40 A KBB	32	4	6	6	4	6	6	10
		2.5 ⁽¹⁾	4 ⁽¹⁾	4 ⁽¹⁾				
	40	4	6	10	6	10	10	10
				6 ⁽¹⁾				

Protection by gG fuses								
Type of busbar trunking	Rated current (A)	XLPE cable			PVC cable			
		Spaced	Touching (number of cables)		Spaced	Touching (number of cables)		
			2 to 5	6 or more		2	3	4 or more
25 A KBA	10	1.5	1.5	1.5	1.5	1.5	1.5	1.5
25 A KBB	16	1.5	2.5	2.5	2.5	2.5	2.5	4
			1.5 ⁽¹⁾					
	20	2.5	2.5	2.5	2.5	4	4	6
		1.5 ⁽¹⁾						
25 A KBA 25 A KBB	25	2.5	4	6	4	6	6	6
				4 ⁽¹⁾				
40 A KBA 40 A KBB	32	4	6	6	6	6	10	10
		2.5 ⁽¹⁾	4 ⁽¹⁾					

(1) Permissible cable cross-sections for single-phase distribution.



Select the short-circuit protection

Determining the prospective short-circuit current at the origin of the Canalis

There are two possible situations:

- the busbar trunking for lighting is supplied by a secondary switchboard.

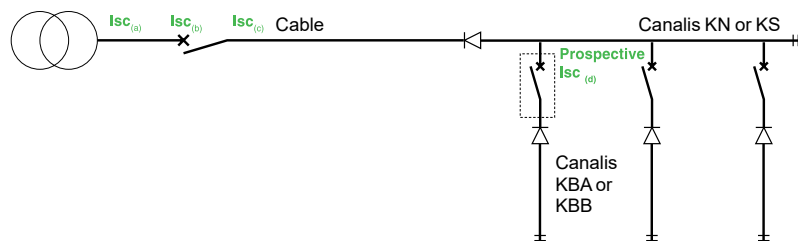
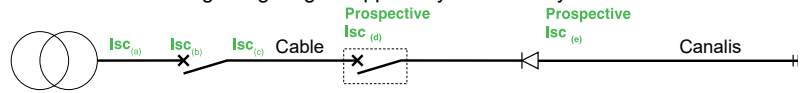

I_{sc(a)}: rms short-circuit current across the transformer terminals.

Rms I _{sc(a)} values across the transformer terminals (U = 400 V)													
Power (kVA)	50	100	150	200	250	315	400	500	630	800	1000	1250	1600
I _{sc(a)} (kA)	1.8	3.6	5.7	7.2	8.9	11.2	14.2	17.6	22.1	24.8	27.8	31.5	36.7

I_{sc(b)}: downstream short-circuit current, less than I_{sc(a)}, limited by cable impedance.

I_{sc(c)}: short-circuit current across circuit-breaker terminals, less than I_{sc(b)}, limited by circuit breaker.

I_{sc(d)}: prospective short-circuit current, limited by cable impedance (case 1) or by impedance of cable + Canalis (case 2).

I_{sc(e)}: prospective short-circuit current, at head of Canalis by the circuit breaker (d) and the impedance of the Canalis supply cable.

Drawn from the Ecodial low-voltage installation-calculation software, produced by Schneider Electric for fast and precise evaluation of prospective short-circuit currents at different points in the circuit.

Please consult your regional sales office.

Canalis and protection coordination

Drawn from tests specified in standards (used in our guides and software), the table below determines the type of circuit breaker or fuse required for a particular type of busbar trunking depending on the prospective short-circuit current at the head of the Canalis trunking.

Type of busbar trunking	Circuit-breaker protection I _{sc(d)} (Prospective I _{sc})					Fuse protection Prospective I _{sc} 50 kA
	10 kA	15 kA	20 kA	25 kA	50 kA	
25 A KBA, 25 A KBB	iC60N25	iC60H25	iC60L25	iC60L25	NC100LH25	20 A gG
40 A KBA, 40 A KBB	iC60N40	iC60H40	iC60L40	iC60L40	NC100LH40	32 A gG

Characteristics of Canalis busbar trunking

Type of busbar trunking	Short-circuit withstand Rated peak short-circuit current (kA)	Permissible thermal stress for 0.1 s ≤ t ≤ 3 s (A ² S)
25 A KBA	4.4	19.5 x 10 ⁴
40 A KBA	9.6	90 x 10 ⁴
25 A KBB	4.4	19.5 x 10 ⁴
40 A KBB	9.6	90 x 10 ⁴

Select the short-circuit protection

The selection guides below can be used to determine the circuit breaker required to fully protect the trunking depending on the prospective short-circuit current of the installation.

Example: in an installation with a prospective *I*_{sc} of 15 kA, the circuit breaker required to protect 25 A KBB trunking is a iC60H (the rating depends on the rated current of the circuit).

In bold, the most appropriate device to the rating of the busbar trunking

Selection guide for 230 / 240 V

Isc max (kA rms) KBA25	10 kA	15 kA	20 kA	25 kA	
Circuit breaker	iC60N10/.../25 iC60N10/.../25 NG125N10/.../25	iC60H10/.../25 iC60H10/.../25	iC60L10/.../25 iC60L10/.../25	iC60L10/.../25 iC60L10/.../25	
Isc max (kA rms) KBB25	10 kA	15 kA	20 kA	25 kA	
Circuit breaker	iC60N10/.../25 iC60N10/.../25 NG125N10/.../25	iC60H10/.../25 iC60H10/.../25	iC60L10/.../25 iC60L10/.../25	iC60L10/.../25 iC60L10/.../25	
Isc max (kA rms) KBA40	10 kA	15 kA	20 kA	25 kA	50 kA
Circuit breaker	iC60N10/.../40 iC60N10/.../40	iC60H10/.../40 iC60H10/.../40	iC60L40 iC60L40 NG125N10/.../40	iC60L10/.../25 iC60L10/.../25	NG125L10/.../40
Isc max (kA rms) KBB40	10 kA	15 kA	20 kA	25 kA	50 kA
Circuit breaker	iC60N10/.../40 iC60N10/.../40	iC60H10/.../40 iC60H10/.../40	iC60L40 iC60L40 NG125N10/.../40	iC60L10/.../25 iC60L10/.../25	NG125L10/.../40

Selection guide for 380 / 415 V

KBA / KBB trunking

Isc max (kA rms) KBA25	10 kA	15 kA	20 kA			
Circuit breaker	iC60N10/.../25 iC60N10/.../25 NG125N10/.../25	iC60H10/.../25 iC60H10/.../25	iC60L10/.../25 iC60L10/.../25			
Isc max (kA rms) KBB25	10 kA	15 kA	20 kA	25 kA		
Circuit breaker	iC60N10/.../25 iC60N10/.../25 NG125N10/.../25	iC60H10/.../25 iC60H10/.../25	iC60L10/.../25 iC60L10/.../25	iC60L10/.../25 iC60L10/.../25		
Isc max (kA rms) KBA40	10 kA	15 kA	20 kA	25 kA	36 kA	
Circuit breaker	iC60N10/.../40 iC60N10/.../40	iC60H10/.../40 iC60H10/.../40	iC60L40 iC60L40 NG125N10/.../40	iC60L10/.../25 iC60L10/.../25	NG125H10/.../40 NG125L10/.../40	
Isc max (kA rms) KBB40	10 kA	15 kA	20 kA	25 kA	36 kA	50 kA
Circuit breaker	iC60N10/.../40 iC60N10/.../40	iC60H10/.../40 iC60H10/.../40	iC60L40 iC60L40 NG125N10/.../40	iC60L10/.../25 iC60L10/.../25	NG125H10/.../40 NG125L10/.../40	NG125L10/.../40



Select the right product to support lightings

The tables below indicate the possible fixing distances in metres. Based on a maximum acceptable deflection of 1/350.

Lights are installed continuously

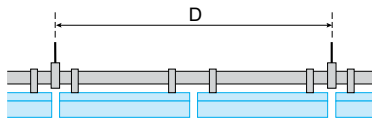

Lights weight per meter (kg)	Distance between support D (m)									
	2	2.5	3	3.5	4	4.5	5	5.5	6	
0 < W < 3.4	KBA	KBA	KBA	KBB	KBB	KBB	KBB			
3.4 < W < 4.6	KBA	KBA	KBA	KBB	KBB	KBB				
4.6 < W < 6.7	KBA	KBA	KBB	KBB	KBB					
6.7 < W < 9	KBA	KBA	KBB	KBB						
9 < W < 16	KBA	KBB	KBB							
16 < W < 24	KBB	KBB								
24 < W < 30	KBB									

Lights are installed between two fixing points

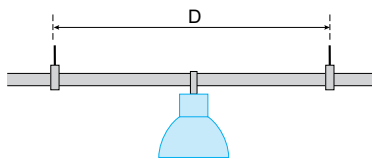
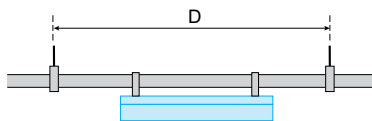

Lights weight (kg)	Distance between support D (m)									
	2	2.5	3	3.5	4	4.5	5	5.5	6	
0 < W < 11	KBA	KBA	KBA	KBB	KBB	KBB	KBB			

Lights are installed next to a fixing point

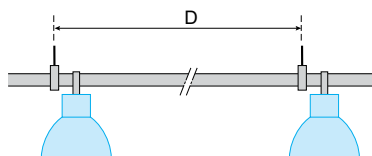
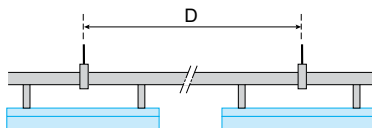

Lights weight (kg)	Distance between support D (m)									
	2	2.5	3	3.5	4	4.5	5	5.5	6	
0 < W < 11	KBA	KBA	KBA	KBB	KBB	KBB	KBB	KBB	KBB	



E

Examples of lighting management

Warehouses

In warehouses, dynamic lighting is essential: light is not necessary all the time, everywhere and at the maximum level. Depending on the time slots and zones, ignition strategies, adaptation of lighting levels, lighting scenarios are possible, up to the creation of atmospheres lights that promote the vigilance of workers, especially at night. **Canalis DALI or KNX control system** connects all luminaires to the controller.

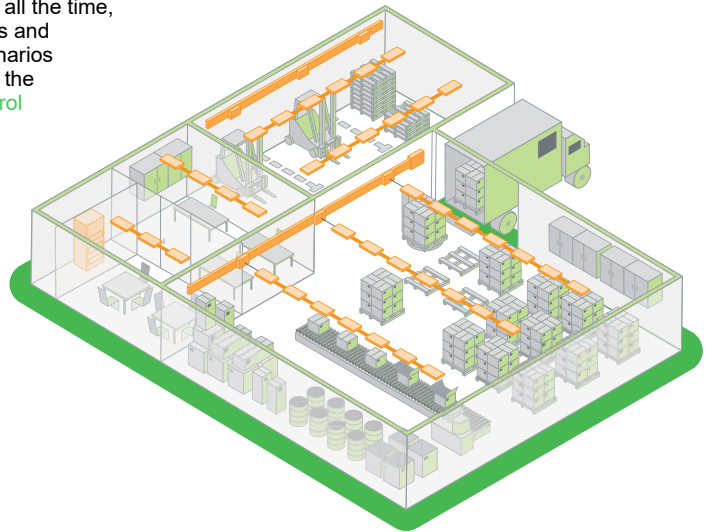
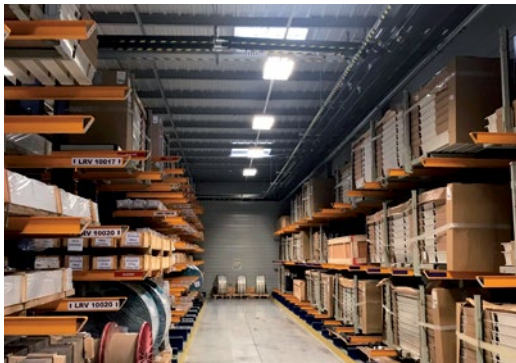

Factory workshops

Depending on the time slots and zones, ignition strategies, adaptation of lighting levels, lighting scenarios are possible. **Canalis DALI or KNX control system** connects all luminaires to the controller.

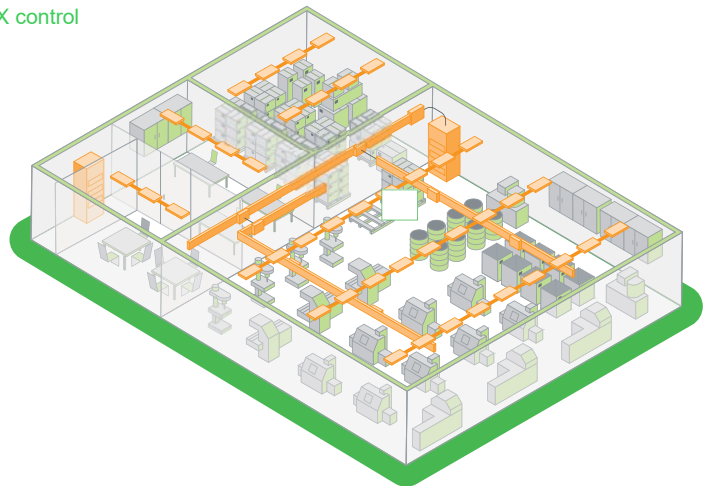

Car park

Low-level lighting in the parking bays, brighter lighting in traffic areas and full brightness in pedestrian areas.

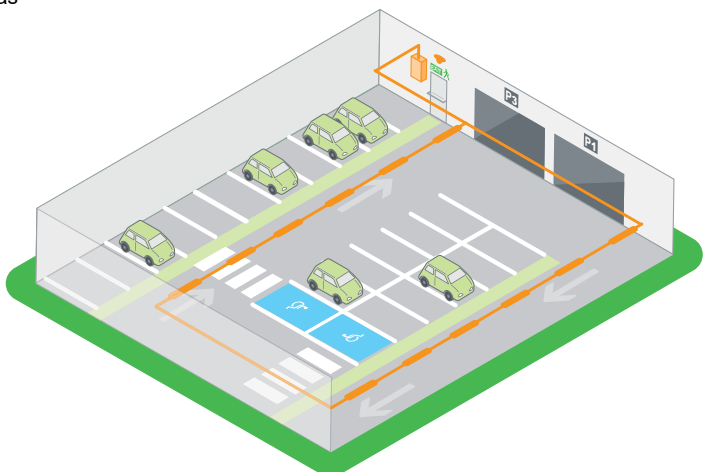

Examples of lighting management

Open-plan office

As and when space is reorganized, it is easy to allocate a new control point for an office or put luminaires together to form a group. The **Canalis DALI or KNX control system** is connected to the BMS. It is possible to create scenarios, control, and supervise lighting points and monitor electricity consumption (see diagram page 61)

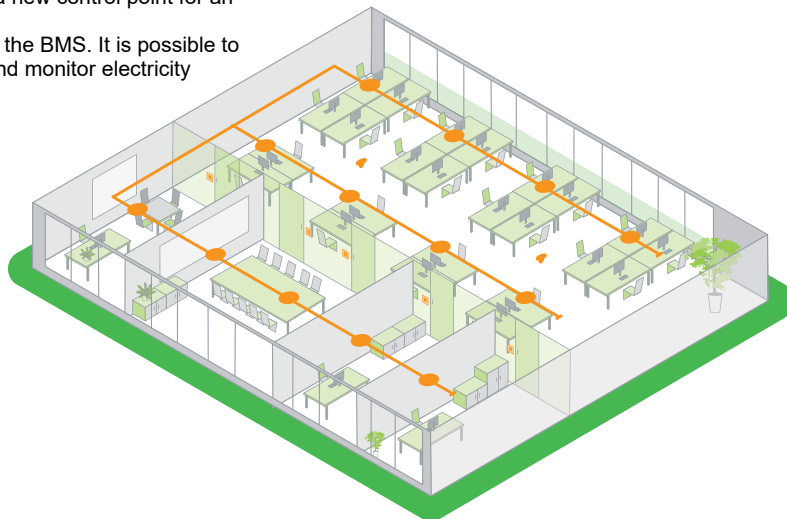

Convenience store

One light in three on during delivery periods, fully lit when the shop is open to the public then lighting lowered again after closing, while the shop is being cleaned. By **powering one, two, or three phases** the brightness level is easily manageable (see diagram page 59)

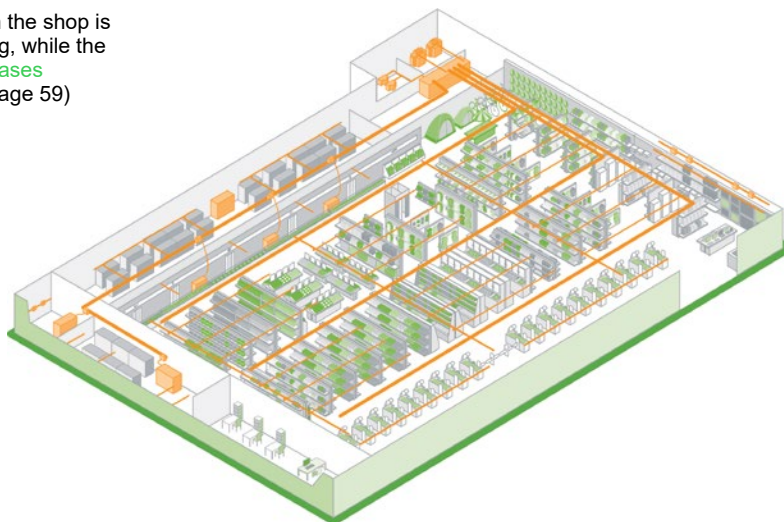

Gymnasium

In large open spaces with a good level of external light, the lighting level can be adjusted by a **dimmer control**. It is also possible to divide the surface area into halves or thirds depending on how the space is used.

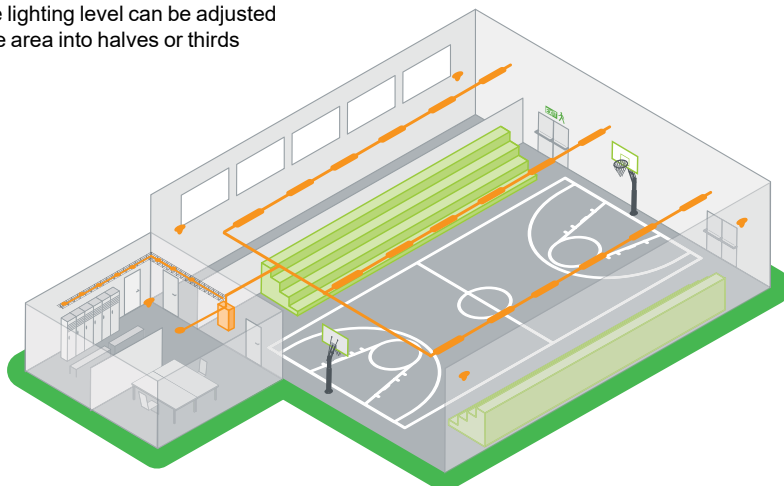
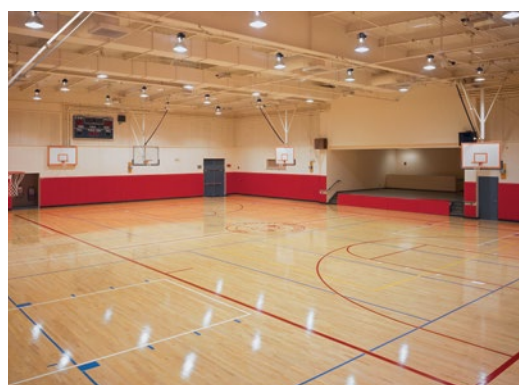

Examples of electrical diagrams

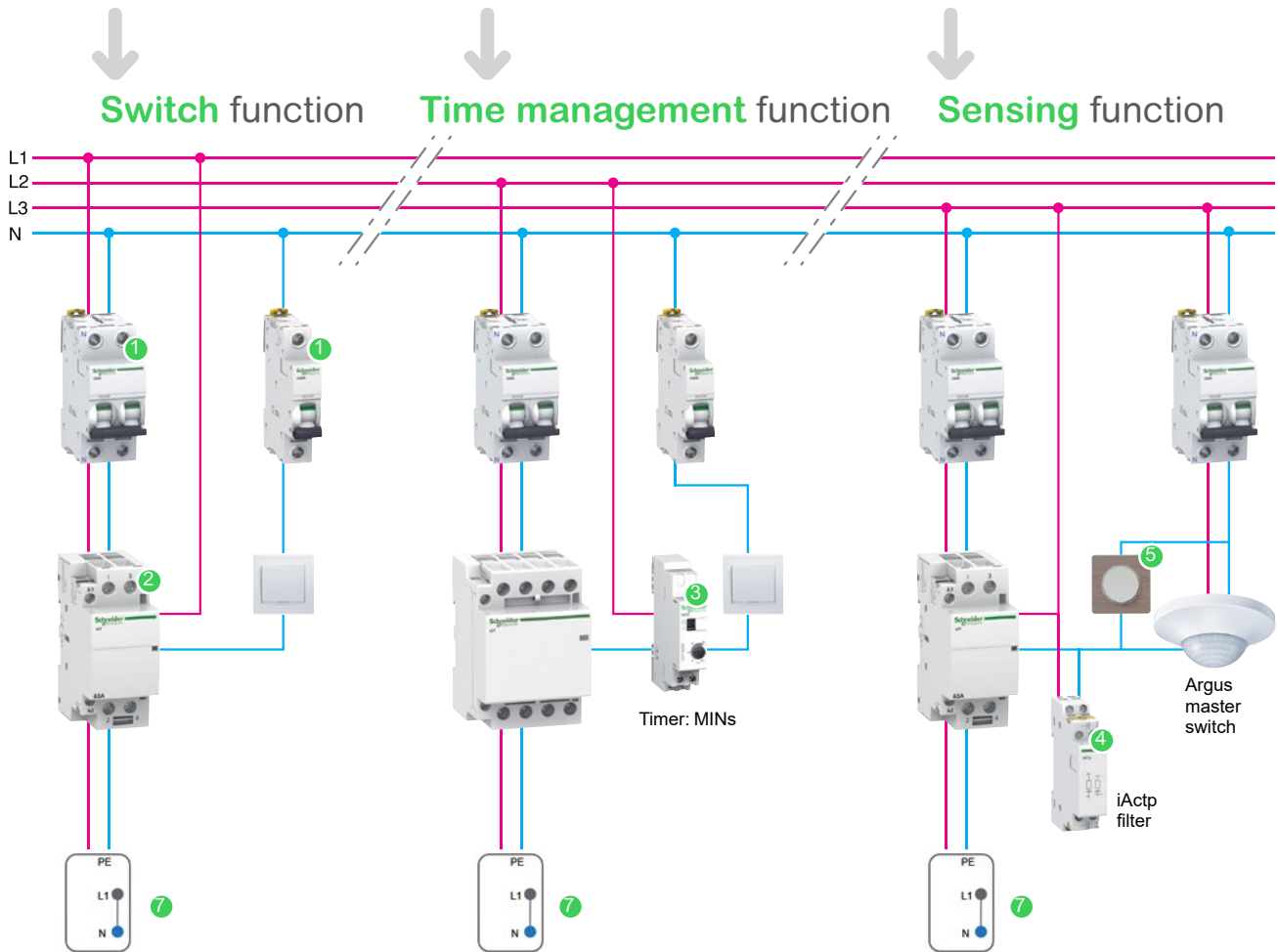

- | | | | |
|---|--|---|--------------------------------------|
| 1 | Protection: 2P iC60N and 1P iC60N circuit-breakers | 4 | Auxiliary: iACTp interference filter |
| 2 | Contactors: 1-ph iCT | 5 | Pushbutton: Odace type |
| 3 | Timer: MINs | 6 | Movement sensor: Argus |
| | | 7 | Canalis KBA |



Examples of electrical diagrams

Centralized management function

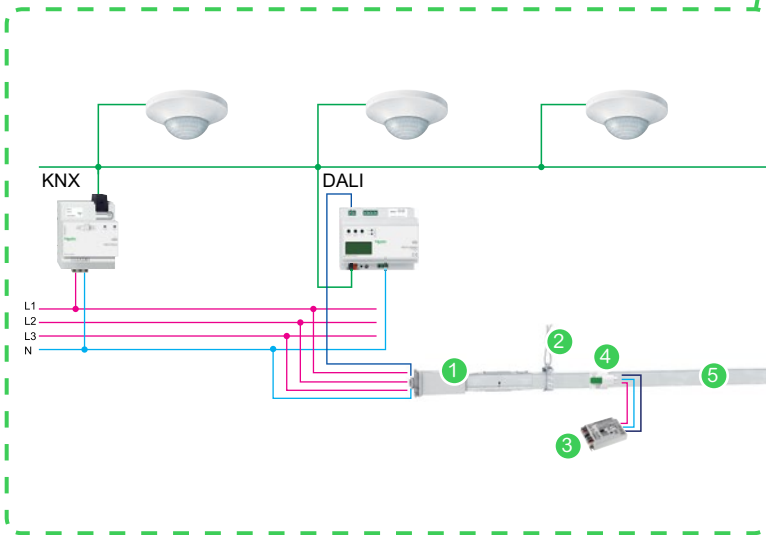
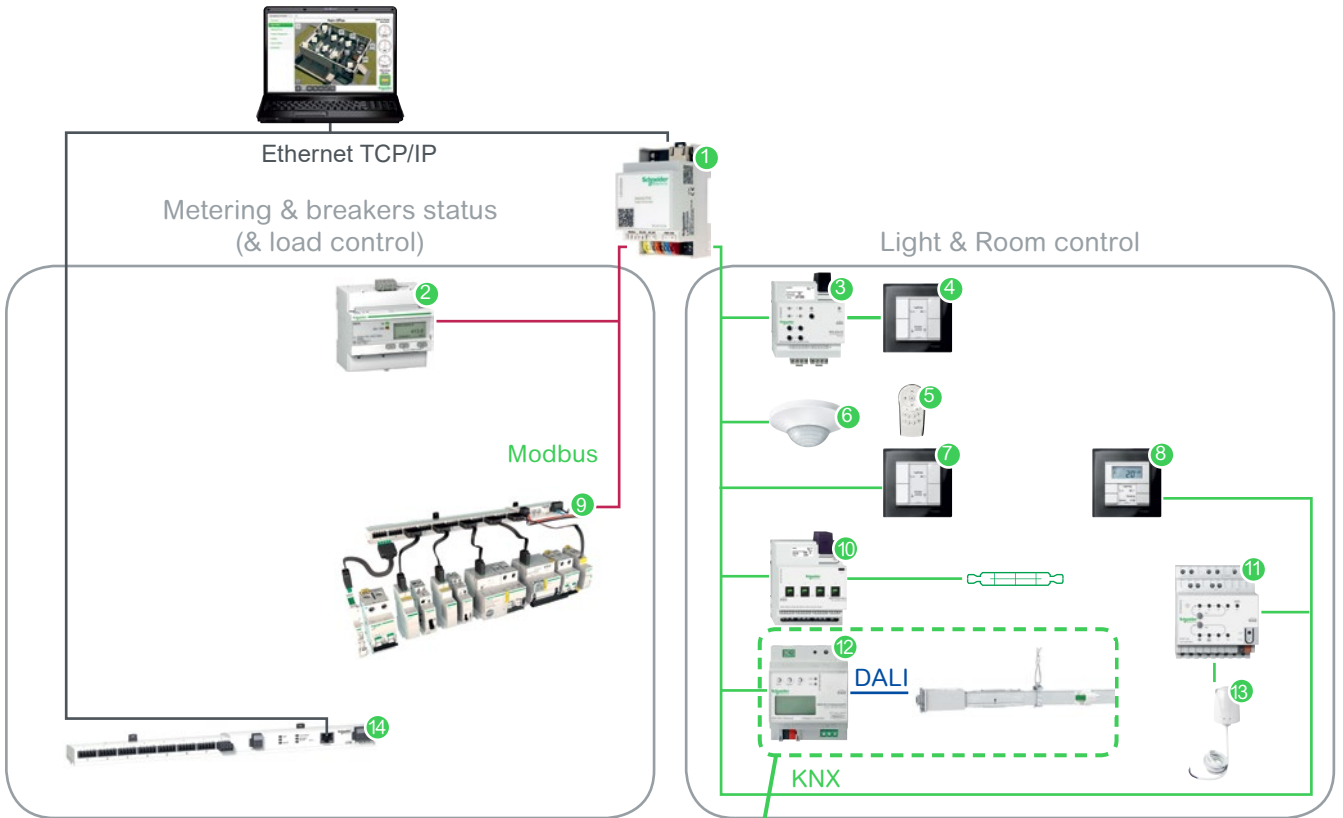

- 1 SpaceLYnk
- 2 Acti9 Energy meter
- 3 Blinds & Shutters actuator
- 4 Push-Button
- 5 Remote
- 6 Presence detector with automatic lighting control
- 7 Push-Button
- 8 Push-Button with temperature control
- 9 Acti9 SmartLink
- 10 Switch actuator
- 11 Fan-Coil actuator (heating & cooling control)
- 12 DALI gateway
- 13 Thermal valve drive
- 14 Acti9 IP SmartLink

- 1 Feed unit
- 2 Clamp
- 3 Electronic ballast
- 4 Connector: *KBC16DCS...T type*
- 5 Canalis: *KBB option T*





Managing the lighting of a convenience store or superette

Lighting in the right place at the right time thanks to pre-cabling and time programming

Customer case

The manager of a convenience store wants to automate its lighting system. His store comprises two separate lighting areas: storage and sales.

In addition, the lighting must be optimized: one luminaire out of three during delivery, after closing and at cleaning time, while full lighting must be ensured during opening hours.

The layout of the shelves in the sales area could be reorganized, and the reallocation of luminaires should be performed with minimum works.

Our recommendation

The system chosen is 25 A KBA Canalis busbar trunking, and the luminaires shall be installed directly under Canalis KBA by means of KBA40ZFU fasteners.

An Acti9 IHP+ 2c clock combined with contactors ensures lighting scripting, and a manual override control of the lighting will be performed from the electrical switchboard.

The alteration of the installation during reorganization of the shelves will be simplified by the modularity and extreme ease of assembly and disassembly of the Canalis components.

Benefits

- **Simplicity and speed of execution:** from design to installation, no constraints, "Canalis" adapts to all store configurations.
- **Attractiveness:** the white-colored Canalis components ensure consistency with the colors of the luminaires.
- **Cost optimization:** automation of the installation reduces electricity consumption.
- **Flexibility:** no works required when reorganizing the store or changing the sales area.

se.com

Life Is On

Schneider
Electric

Solution

Diagram

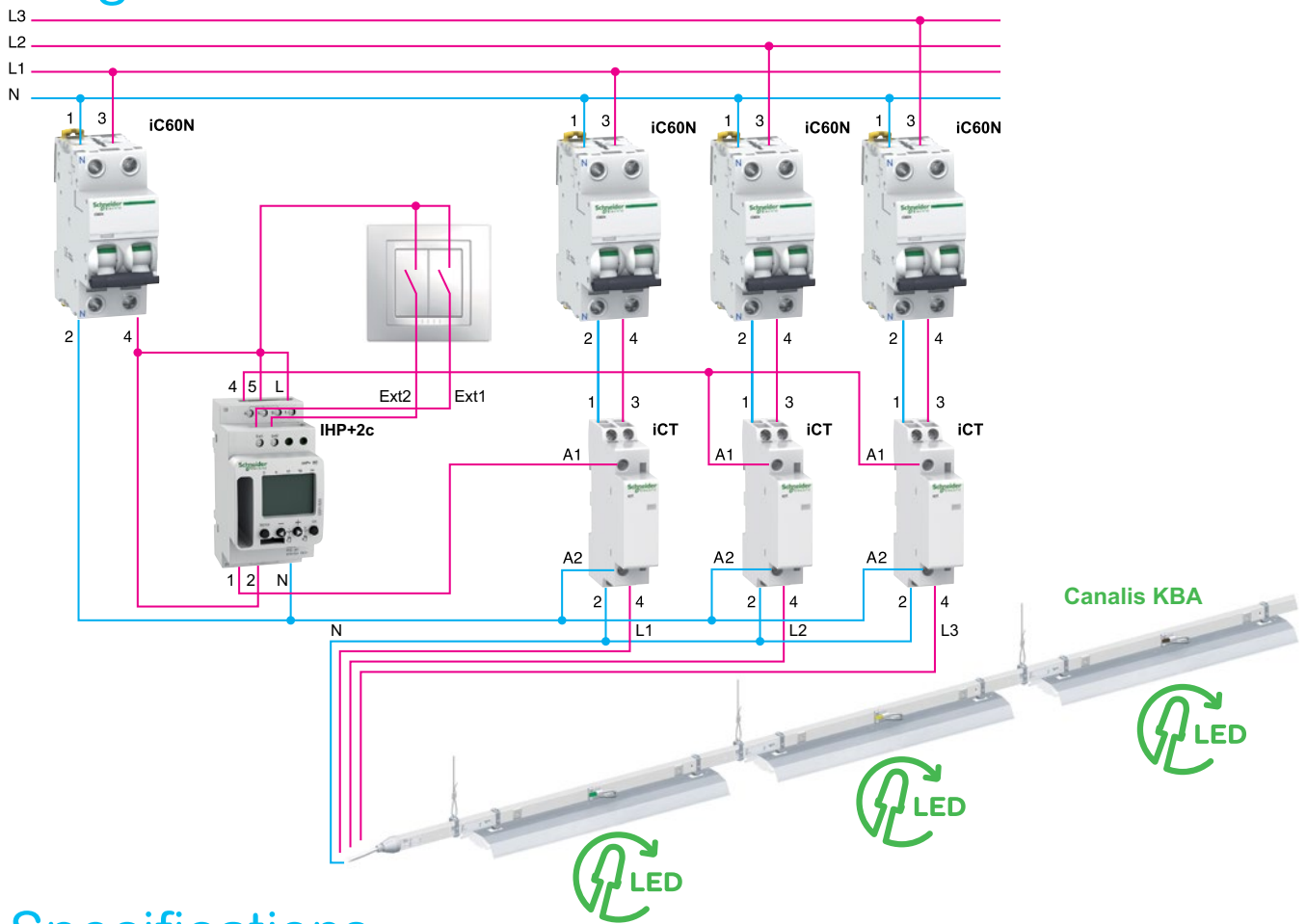

Specifications

- The decentralized lighting electrical distribution architecture shall be prefabricated.
- The lighting layout should possibly be reorganized without altering the electrical installation.
- A busbar trunking system should ensure simplification of office rearrangement.

Products used

Product	Function	Quantity	Reference
Canalis KBA	25 A straight element	-	KBA25ED4303W
Canalis KBA	25 A power supply box	1	KBA25ABG4W
Canalis KBA	Fasteners	-	KBA40ZFU
Canalis busbar trunking	Tap-off connectors	-	KBC10DCS101, 201, 301
Acti9 iC60N	MCB 2P	1	Depend on rating
Acti9 IHP+ 2c	Programmable time switch with 2 output contacts	1	CCT15553
Acti9 iC60N	MCB 2P	3	Depend on rating
Acti9 iCT	25 A 2P contactor	3	Depend on rating

More about
Canalis KBA



Scan or click on
QR code

se.com

Life Is On

Schneider
Electric

Schneider Electric Industries SAS
35, rue Joseph Monier - CS 30323
F92506 Reuil-Malmaison Cedex

Document Number DEBU036EN ©2022 Schneider Electric. All Rights Reserved.
Life Is On Schneider Electric is a trademark and the property of Schneider Electric SE, its subsidiaries and affiliated companies



Lighting management for an office space

Lighting in the right place at the right time

Customer case

The manager of an office space needs to organize the lighting layout. He also wants to achieve energy savings by implementing automatic switching on/off of the lighting according to the presence of people and the level of luminosity.

In addition, each office lighting must be switched off automatically after a certain period of time in the absence of people.

As the offices are regularly rearranged, the installation must be easy to modify.

Our recommendation

The system chosen is Canalis busbar trunking incorporating a DALI architecture without programming. Automatic lighting is provided by master and slave DALI presence detectors, and adjustment of the constant luminosity level office by office is an integral function of the master Argus detectors. These detectors are fastened directly to the busbar trunking or are simply connected to it according to the layout of the offices. Information is transferred uniformly to all the ballasts connected to the master detector network, and an override control of the lighting is performed by push buttons connected to the (master) DALI detector.

* DALI: Digital Addressable Lighting Interface.

Benefits

- Fewer cables: a single duct incorporates the power and the DALI communication buses for the master and slave Argus detectors and DALI ballast (option T of the KBA product ranges).
- Communication between the master and slave Argus devices and override control push buttons uses the power supply conductor (power line carrier).
- The prefabricated lighting electricity distribution system allows flexibility of installation for arrangement or rearrangement of space, without altering the electrical structure.
- Modification of the installation will be easy thanks to the modularity and extreme ease of assembly and disassembly of the Canalis components.

se.com

Life Is On

Schneider
Electric

Solution Diagram

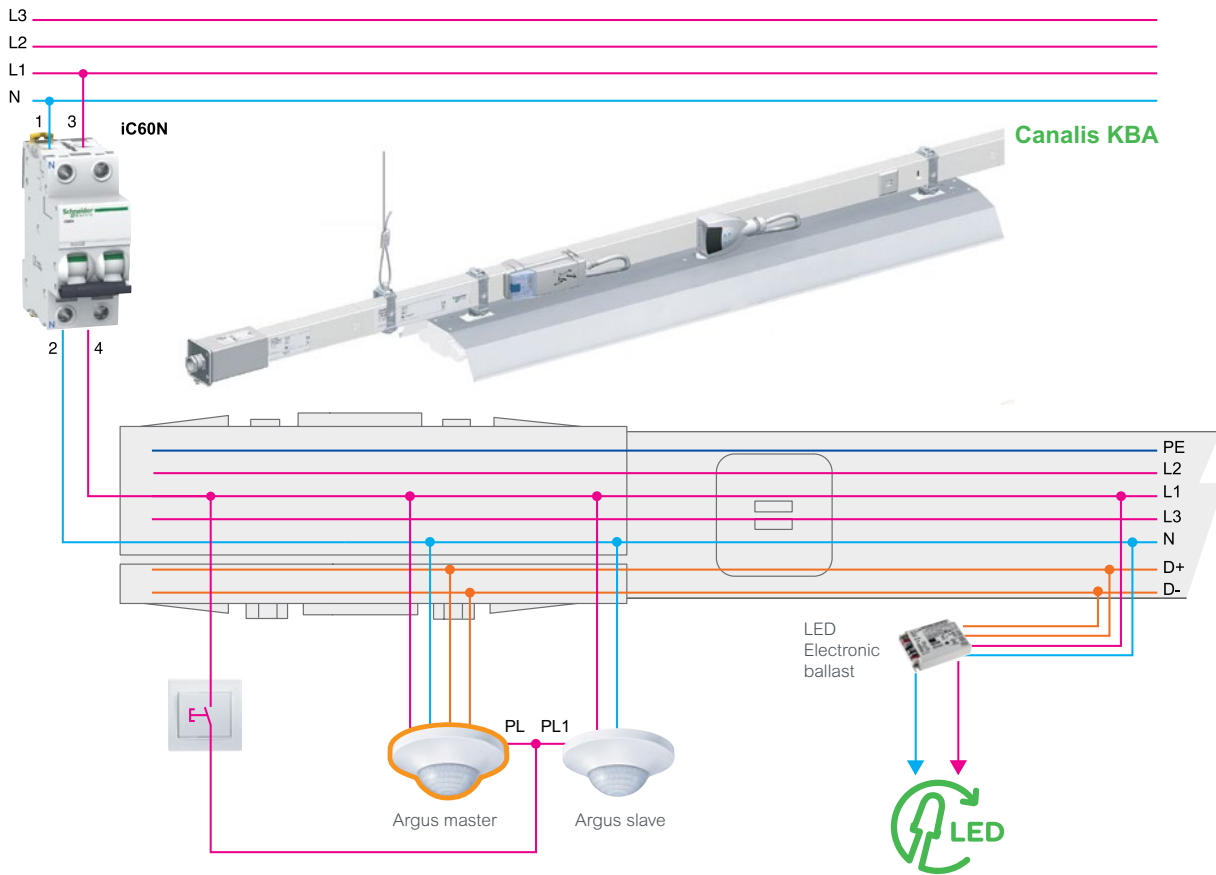

Specifications

- Decentralized DALI lighting system without programming must be used to control the lighting.
- The use of a busbar trunking system should insure simplification of office rearrangement.

Products used			
Product	Function	Quantity	Reference
Canalis busbar trunking	Tap-off connectors	1	KBC16DCB21+KBC16ZT1
Canalis busbar trunking	Connectors for Argus master detector	1	KBC16DCB40+KBC16ZT1
Canalis busbar trunking	Connectors for Argus slave detector	1	KBC10DCB40
Canalis KBA	40 A straight element (with communication bus)	-	KBA40ED4303TW
Canalis KBA	40 A power supply box	1	KBA40ABG4TW
Canalis KBA	Fasteners	-	KBA40ZFU
Acti9 iC60N	MCB 1P+N	1	Depend on rating

More about Canalis KBA



Scan or click on QR code

se.com

Life Is On

Schneider Electric

Schneider Electric Industries SAS
35, rue Joseph Monier - CS 30323
F92506 Rueil-Malmaison Cedex

Document Number DEBU036EN ©2022 Schneider Electric. All Rights Reserved.
Life Is On Schneider Electric is a trademark and the property of Schneider Electric SE, its subsidiaries and affiliated companies



Light management of a large office building

Control of energy consumption and easy reallocation

Customer case

The facility manager wants to automate the lighting of a large office building, while keeping the possibility of local control, energy consumption management and luminaire maintenance.

He also needs to adapt the lighting according to a timer program, the presence of people and the level of natural light based on several areas.

In addition, he wants to perform override control of lighting by area, and rapidly reallocate a work area.

Our recommendation

The choice to make is a KNX type Building Management System, connected to a "Canalis KBB" busbar trunking architecture with 1 or 2 electrical network, DALI-compatible, performing lighting management, measuring and monitoring.

KNX presence detectors located in each area maintain a constant luminosity level in the presence of employees, for optimal working conditions.

Override setting of the lighting for each area is performed by KNX switches, and fault information is sent by the ballasts via the DALI communication network.

In case of rearrangement, it is easy to allocate new monitoring points for an office or group of luminaires.

* DALI: Digital Addressable Lighting Interface.

Benefits

- **Fast installation:** Canalis busbar trunking, formed of prefabricated elements, can be installed rapidly and with protection. Connections require no tools and are designed to prevent any risk of incorrect connection.
- **Flexibility:** reallocation of the various offices is made easy.
- **Simplified maintenance:** no preventive maintenance campaign (renewal of the lamps according to their service life).
- **Efficiency:** simple lighting management and cost optimization scenarios.

se.com

Life Is On

Schneider
Electric

Solution Diagram

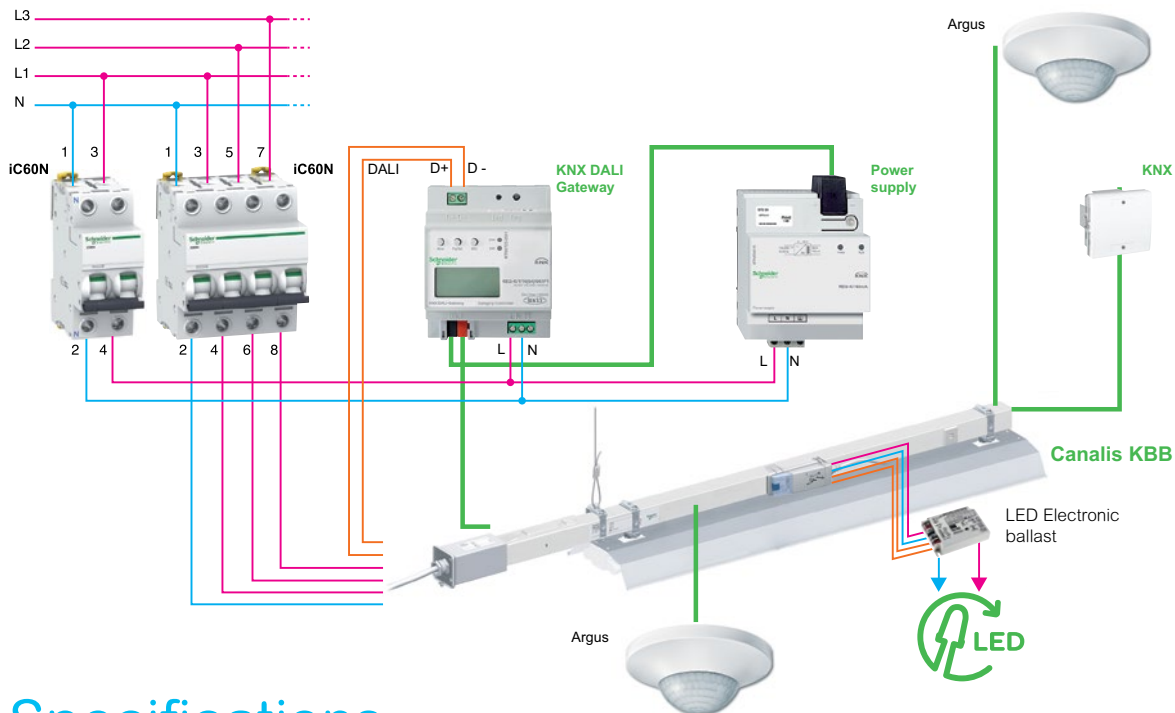

Specifications

- The lighting management system has to be a decentralized distribution system incorporating a DALI communication bus connected to the Building Management System. It should perform control of the luminaires by area, and allow the creation of lighting scenarios according to the occupants' hours of presence and the extinguishing of unoccupied areas.
- The solution should be based on prefabricated elements with tap-offs, being completely scalable.
- The connections should be done without tools.

Products used			
Product	Function	Quantity	Reference
Canalis KBB	40 A straight element (with communication bus)	-	KBB40ED4303TW, KBB40ED44305TW
Canalis KBB	40 A power supply box	1	KBB40ABG4TW, KBB40ABG44TW
Canalis busbar trunking	Fasteners	-	KBA40ZFU
Canalis busbar trunking	Tap-off connectors	-	KBC16DCB21 + KBC16ZT1
KNX Push Button	Push button	1	NU553018
KNX power supply	Power supply	1	MTN684064, MTN684032
KNX DALI Gateway	Communication gateway	1	MTN6725-0001
KNX Argus	Presence detector	3	MTN630919
Acti9 iC60N	MCB 1P+N	1	Depend on rating
Acti9 iC60N	MCB 3P+N	1	Depend on rating

More about Canalis KBB



Scan or click on QR code

se.com

Life Is On

Schneider Electric

Schneider Electric Industries SAS
35, rue Joseph Monier - CS 30323
F92506 Rueil-Malmaison Cedex

Document Number DEBU036EN ©2022 Schneider Electric. All Rights Reserved.
Life Is On Schneider Electric is a trademark and the property of Schneider Electric SE, its subsidiaries and affiliated companies

Catalogue numbers

Catalogue numbers	Weight (kg)	Page	Catalogue numbers	Weight (kg)	Page
KBA25ABG4W	0.200	23, 24, 30	KBB40DF4420TW	1.900	32, 34
KBA25ED2202W	1.900	24	KBB40DF4420W	1.900	24, 30
KBA25ED2300W	2.600	24	KBB40ED2202W	1.700	26
KBA25ED2302W	2.400	24	KBB40ED2300W	2.700	26
KBA25ED2303TW	2.600	34	KBB40ED2303W	2.700	26
KBA25ED2303W	2.600	24	KBB40ED4202W	1.900	26
KBA25ED2305TW	2.600	34	KBB40ED4300W	3.100	26
KBA25ED2305W	2.600	24	KBB40ED4303W	3.100	26
KBA25ED4202W	1.900	24, 30	KBB40ED22203TW	3.600	34
KBA25ED4300W	2.600	24, 30	KBB40ED22203W	3.600	24
KBA25ED4302W	2.400	24, 30	KBB40ED22300W	5.200	24
KBA25ED4303TW	2.600	32, 34	KBB40ED22303W	5.200	24
KBA25ED4303W	2.600	23, 24, 30	KBB40ED22305TW	5.200	34
KBA25ED4305TW	2.600	32, 34	KBB40ED42203TW	3.800	32, 34
KBA25ED4305W	2.600	24, 30	KBB40ED42203W	3.800	24, 30
KBA40ABD4TW	0.500	32, 34	KBB40ED42300W	5.700	24, 30
KBA40ABD4W	0.500	24, 30	KBB40ED42305TW	5.700	32, 34
KBA40ABG4TW	0.400	32, 34	KBB40ED42305W	5.700	24, 30
KBA40ABG4W	0.400	24, 30	KBB40ED44203TW	3.800	34
KBA40ABT4W	0.500	24, 30, 32, 34	KBB40ED44203W	3.800	24
KBA40AF	0.700	39	KBB40ED44300W	6.100	24
KBA40DF405TW	1.500	32, 34	KBB40ED44305T2W	6.100	34
KBA40DF405W	1.500	24, 30	KBB40ED44305TW	6.100	34
KBA40DF420TW	4.500	32, 34	KBB40ED44305W	6.100	24
KBA40DF420W	4.500	24, 30	KBB40EDA20W	1.600	39
KBA40ED2203TW	1.900	34	KBB40ZFC	0.020	38
KBA40ED2203W	1.900	24	KBB40ZFC5	0.050	38
KBA40ED2300W	3.100	24	KBB40ZFC6	0.050	38
KBA40ED2303TW	3.100	34	KBB40ZFG1	0.100	38
KBA40ED2303W	3.100	24	KBB40ZFG2	0.200	38
KBA40ED2305TW	3.100	34	KBB40ZFGU	0.005	38
KBA40ED2305W	3.100	24	KBB40ZFL	0.055	38
KBA40ED4203TW	1.900	32, 34	KBB40ZFMP	0.040	38
KBA40ED4203W	1.900	24, 30	KBB40ZFPU	0.160	38
KBA40ED4300W	3.100	24, 30	KBB40ZFS23	0.070	38
KBA40ED4303TW	3.100	32, 34	KBB40ZFSL	0.035	38
KBA40ED4303W	3.100	24, 30	KBB40ZFSU	0.105	24, 26, 30, 32, 34, 38
KBA40ED4305TW	3.100	32, 34	KBB40ZFU	0.050	24, 26, 30, 32, 34, 38
KBA40ED4305W	3.100	24, 30	KBB40ZFU2W	0.105	38
KBA40EDA20W	1.600	39	KBC10DCB20	0.065	23, 28, 31
KBA40ZFG2	0.200	38	KBC10DCB40	0.065	28, 31
KBA40ZFSL	0.105	38	KBC10DCC211	0.165	28, 31
KBA40ZFSU	0.105	24, 30, 32, 34, 38	KBC10DCS101	0.100	28, 31
KBA40ZFU	0.050	23, 24, 30, 32, 34, 38	KBC10DCS201	0.100	28, 31
KBA40ZFU2W	0.105	38	KBC10DCS301	0.100	28, 31
KBB25ED2300W	2.400	26	KBC16DCB21	0.090	28, 31, 33, 36
KBB25ED2303W	2.400	26	KBC16DCB22	0.090	28, 31, 33, 36
KBB25ED4300W	2.600	26	KBC16DCB40	0.090	28, 31, 33, 36
KBB25ED4303W	2.600	26	KBC16DCB216	0.090	29
KBB25ED22300W	4.600	24	KBC16DCB226	0.090	29
KBB25ED22303W	4.600	24	KBC16DCF21	0.090	28, 31, 33, 36
KBB25ED22305TW	4.600	34	KBC16DCF22	0.090	28, 31, 33, 36
KBB25ED42300W	4.700	24, 30	KBC16DCF40	0.090	28, 31, 33, 36
KBB25ED42305TW	4.700	32, 34	KBC16DCF216	0.090	29
KBB25ED42305W	4.700	24, 30	KBC16DCF226	0.090	29
KBB25ED44300W	4.800	24	KBC16DCP1	0.090	28, 31, 33, 36
KBB25ED44305TW	4.800	34	KBC16DCP2	0.090	28, 31, 33, 36
KBB25ED44305W	4.800	24	KBC16DCS101T	0.150	33, 36
KBB40ABD4W	0.500	26	KBC16DCS201T	0.150	33, 36
KBB40ABD44TW	0.500	32, 34	KBC16DCS301T	0.150	33, 36
KBB40ABD44W	0.500	24, 30	KBC16ZB1	0.005	39
KBB40ABG4W	0.400	26	KBC16ZC1	0.020	39
KBB40ABG44T2W	0.400	34	KBC16ZL10	0.002	39
KBB40ABG44TW	0.400	32, 34	KBC16ZL20	0.002	39
KBB40ABG44W	0.400	24, 30	KBC16ZL30	0.002	39
KBB40ABT4W	0.400	26	KBC16ZT1	0.010	33, 36, 39
KBB40ABT44W	0.500	24, 30, 32, 34	KFB25CD253	1.115	38
KBB40AF	0.018	39			
KBB40DF405W	0.800	24, 26			
KBB40DF420W	1.900	24, 26			
KBB40DF4405TW	0.800	32, 34			
KBB40DF4405W	0.800	24, 30			

Catalogue numbers

G



Schneider Electric Industries SAS

35, rue Joseph Monier
CS 30323
92506 Rueil Malmaison Cedex
France

RCS Nanterre 954 503 439
Capital social 896 313 776 €
www.se.com

03-2022
DEBU036EN