

# INSTRUCTION

Rounded Midi  
582108.0031.19



~ 230 V 50/60 Hz IP 66, IP 66 IK07



 3 x 0,75 - 2,5 mm<sup>2</sup>



Umgebungstemperatur /  
temperature ambiante  
=> -20 °C ... + 45 °C

 2,50 mm<sup>2</sup>

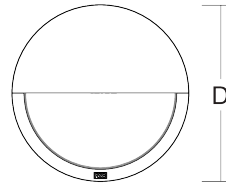

D 300, H 77



2,04 kg



$\Phi_{\text{B}}$  [lm]

$P_{\text{B}}$  [W]

$P_{\text{L}}$

LED

220

4,5

1 x 4 W

CCT [K]

CRI

RG  $\text{\textcircled{B}}$

EEK 

3000

80

RG 1

D

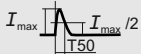

$\text{COS } \varphi$

5 A / 150  $\mu$ s

0,93

$f_{\text{min}} - f_{\text{max}}$   
[MHz]

$p_{\text{EIRP}}$  [mW]

5725 - 5875

0,2





### Allgemeine Sicherheitshinweise

- Der elektrische Anschluss muss ordnungsgemäß nach geltenden Normen und den nationalen sowie internationalen Sicherheits- und Unfallverhütungsvorschriften erfolgen.
- Beschädigte Leuchten dürfen nicht betrieben werden.
- Keine Haftung für Schäden durch unsachgemäßen Einsatz.
- Bei Instandsetzung nur Originalteile verwenden.
- Tragfähigkeit der Decke und Befestigungselemente sicherstellen.

### Betrieb der Leuchte

- Die unzulässigen Umgebungstemperaturen reduzieren die Lebensdauer der Leuchte, im Extremfall droht der Frühausfall.
- Zur Vermeidung von EMV-Problemen die Durchgangsverdrahtung nicht entlang der Leuchtenverdrahtung führen.
- Steuereingänge von dimmbaren Leuchten mit handelsüblichen für Netzspannung geeigneten Leitungen anschließen.

### Manipulationen unserer Produkte sind unzulässig

Veränderung, Umarbeitung, Umkennzeichnung von Produkten sowie deren Verpackung sind unzulässig und verletzen u.a. unsere eingetragenen Warenzeichenrechte. Solche Modifikationen können technische Eigenschaften unserer Produkte negativ beeinflussen, diese zerstören und möglicherweise Folgeschäden an anderen Objekten verursachen. Für durch derartige Modifikationen verursachte Schäden kann der Hersteller in keinem Fall verantwortlich gemacht werden.



### General Safety Information

- Electric connection must be appropriate according to all applicable standards and other national and international safety and accident prevention regulations.
- Damaged luminaires must not be operated.
- No liability is accepted for damages resulting from improper use.
- Use genuine parts only for repair.
- Ensure stability of the ceiling and fastening elements.

### Operation of the luminaire

- Exceeding the permissible ambient temperature will reduce the luminaire's lifecycle, resulting in premature failure in extreme cases.
- Avoid ESD problems by not routing feed-through wiring directly along the wiring of the luminaire.
- Connect control inputs of dimmable luminaires with standard cables suitable for power supply voltage.

### Manipulation of our products is not permitted

Modifications, reworking, re-labelling of products as well as their package is not permitted and infringes, amongst others, our registered trademark rights. Such modifications may affect technical properties of our products, damage them and possibly cause consequential damage to other objects. The manufacturer shall not be responsible under any circumstances for damage caused by such modifications.





Bei Fragen zu unseren Symbolen, besuchen Sie folgende Webseite:  
 If you have any questions about our signs, visit the following website:



[https://www.rzb.de/fileadmin/assets/downloads/PDF/RZB\\_Symbolklaerung.pdf](https://www.rzb.de/fileadmin/assets/downloads/PDF/RZB_Symbolklaerung.pdf)



Dieses Produkt enthält eine Lichtquelle der Energieeffizienzklasse D entsprechend Verordnung (EU) 2019/2015

---

This product contains a light source of energy efficiency class D according to regulation (EU) No 2019/2015

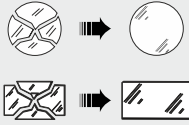



Jede zersprungene Schutzabdeckung ist zu ersetzen. DIN EN 60598

---

Replace any cracked protective shield. IEC DIN EN 60598

Hinweis zum Einsatz von Leuchten mit D - Kennzeichnung nach EN 60598-2-24  
 Reference for application of lumiaires with D - marking according to EN 60598-2-24

 IP 4x	Umgebung ohne Staubablagerung Environment without dust deposit
 IP 5x	Umgebung mit nicht elektrisch leitender Staubablagerung Environment with non-electrically conductive dust deposit
 IP 6x	Umgebung mit elektrisch leitender Staubablagerung Environment with electrically conductive dust deposit



## DIP-Schalter-Einstellungen / DIP Switch Settings

### 1 Erfassungsbereich / Detection Range

Die Sensorempfindlichkeit kann durch Auswahl der Kombination an den DIP-Schaltern genau auf die jeweilige Anwendung eingestellt werden.

The sensor sensitivity can be adjusted by selecting the combination at the DIP switches to exactly match the respective application by selecting the combination on the DIP switches.

	1	2	
I	●	●	100%
II	●	○	75%
III	○	●	50%
IV	○	○	10%



I – 100%  
II – 75%  
III – 50%  
IV – 10%

### 2 Haltezeit / Hold Time

Wählen Sie den DIP-Schalter für die Einschaltzeit des Lichts nach der Anwesenheit-Erkennung. Diese Funktion ist deaktiviert, wenn das natürliche Licht ausreicht.

Select the DIP switch conuguration for the light on-time after presencedetection. This function is disabled when natural light is suficient.

	3	4	
I	●	●	5s
II	●	○	90s
III	○	●	5min
IV	○	○	15min



I – 5s  
II – 90s  
III – 5min  
IV – 15 min

### 3 Tageslicht-Schwellenwert / Daylight Threshold

Stellen Sie den Pegel entsprechend der Beschaffenheit und der Umgebung ein. Das Licht schaltet sich nicht ein, wenn die Umgebungshelligkeit den eingestellten Schwellenwert für Tageslicht überschreitet. Bitte beachten Sie, dass sich die Umgebungsluxwerte auf das interne Licht beziehen, das den Sensor erreicht. Durch die Deaktivierung des Tageslichtsensors wird der Sensor in den Modus versetzt.

Set the level according to the xture and environment. The light will not turn on if ambient lux level exceeds the daylight threshold preset. Please note that the ambient lux level refers to internal light reaching the sensor. Disabling the daylight sensor will put the sensor into occupancy detection only mode.

	5	6	
I	●	●	Disable
II	●	○	50Lux
III	○	●	10Lux
IV	○	○	2Lux



I – Disable  
II – 50 Lux  
III – 10 Lux  
IV – 2 Lux



**EG-Konformitätserklärung**  
**EC-Declaration of Conformity**  
**Déclaration UE de conformité**  
**Declaración de conformidad CE**  
**Deklaracja zgodności UE**



**Hersteller, Anschrift:**  
**Manufacturer, address:**  
**Fabricant, adresse:**  
**Fabricante, dirección:**  
**Producent, adres:**

**RZB Rudolf Zimmermann, Bamberg GmbH**  
**Rheinstrasse 16**  
**96052 Bamberg**  
**Deutschland / Germany / Allemagne / Alemania / Niemcy**

Wir erklären in alleiniger Verantwortung, dass das Produkt  
*We declare under sole responsibility that the product*  
*Nous déclarons, sous notre propre responsabilité, que le produit*  
*Declaramos bajo nuestra sola responsabilidad que el producto*  
*Deklarujemy z pełną odpowiedzialnością, że produkt*

**Produktbezeichnung:**  
**Product designation:** **Rounded Midi**  
**Description des produits:**  
**Designación de producto:** **582108.0031.19**  
**Oznaczenie produktu:**

mit den folgenden EG-Richtlinien und Normen übereinstimmt:  
*complies with the following EC Directives and standards:*  
*est conforme aux normes et directives de l'UE suivantes:*  
*cumple con las siguientes directivas y normas CE:*  
*jest zgodny z następującymi dyrektywami UE i normami:*

<p><b>RED Directive</b> 2014/53/EU</p>	<p><b>(3.1a)</b>  EN 50663:2017  EN 60598-1:2021/A11:2022  EN 60598-2-1:1989  EN 62471:2008  EN 62493:2010  <b>(3.1b)</b>  EN 301 489-1:V2.2.3  EN 301 489-3:V2.3.2  EN 55015:2019/A11:2020  EN 61000-3-2:2019/A1:2021  EN 61000-3-3:2013+A1:2019+A2:2021+A2:2021/AC:2022  EN 61547:2023  <b>(3.2)</b>  EN 300 440:V2.1.1</p>
<p><b>RoHS Directive</b> 2011/65/EU</p>	<p>EN 63000:2018</p>
<p><b>ErP Directive</b> 2009/125/EC</p>	<p>(EU) 2019/2020</p>

Dokument-Nr. / Document No. / Document No. **24002406**  
Document No. / Nr dokumentu

Aussteller / Issuer / Délivré par: **RZB Rudolf Zimmermann, Bamberg GmbH**  
Otorgante / Wystawca:

Ort, Datum / Place, Date / Lieu, date: **Bamberg, 02.02.2024**  
Lugar, Fecha / Miejsce, data:

Rechtsverbindliche Unterschrift:  
Legally binding signature:  
Signature juridiquement obligatore:  
Firma legalmente vinculante:  
Prawnie wiązacy podpis:

  
Reiner Jürgens  
CEO/Direktor Zarządzający/Geschäftsführer

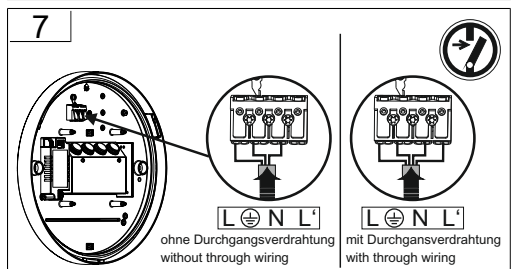
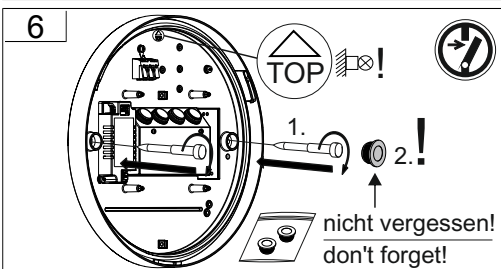
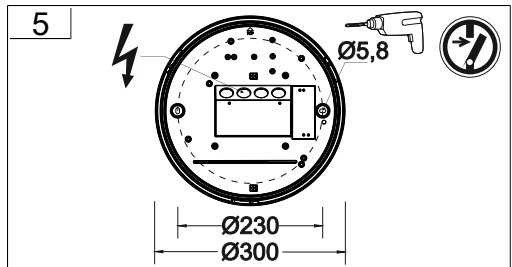
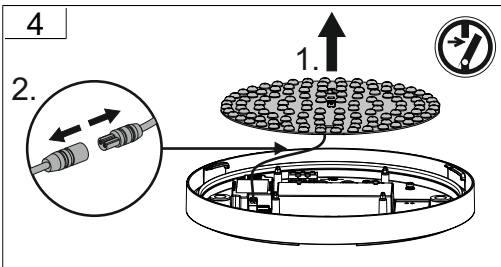
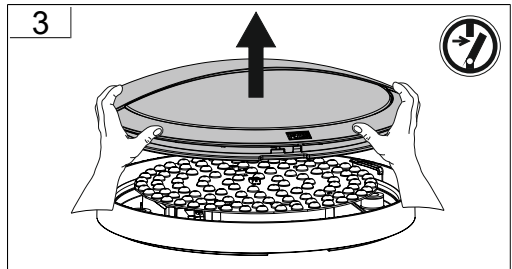
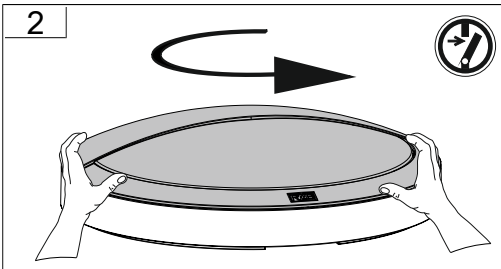
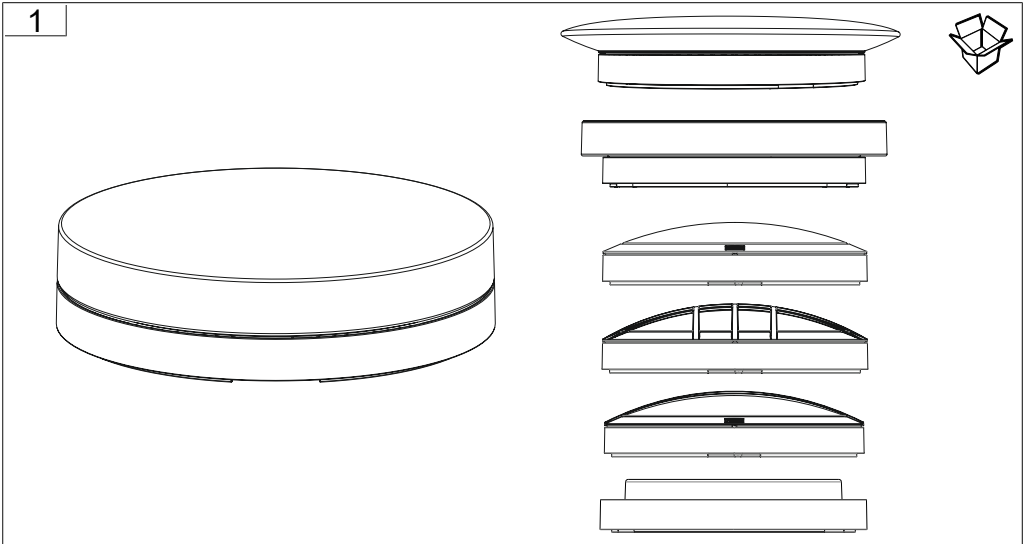



8

## Konvertereinstellung / Converter setting

Iout	Pout	1	2	
90 mA	3,8W	-	-	3000K → 220-260lm 4000K → 220-270lm
140 mA	5,9W	-	ON	
190 mA	8W	ON	-	3000K → 560-670lm 4000K → 560-690 lm
240 mA	10,1W	ON	ON	

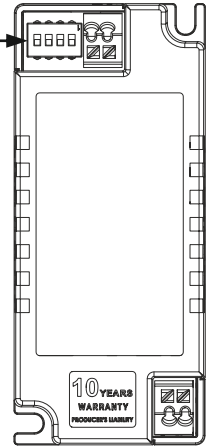

9

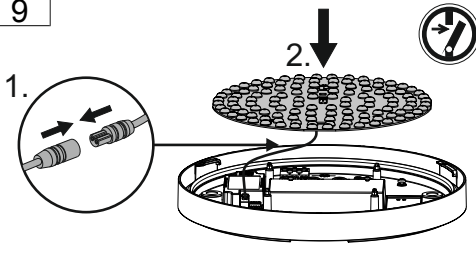

10

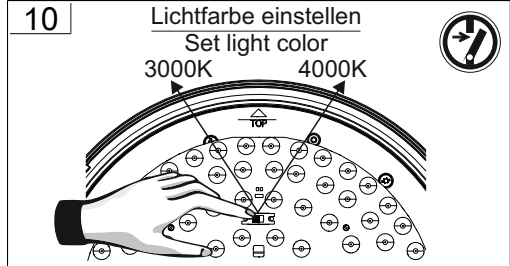

11

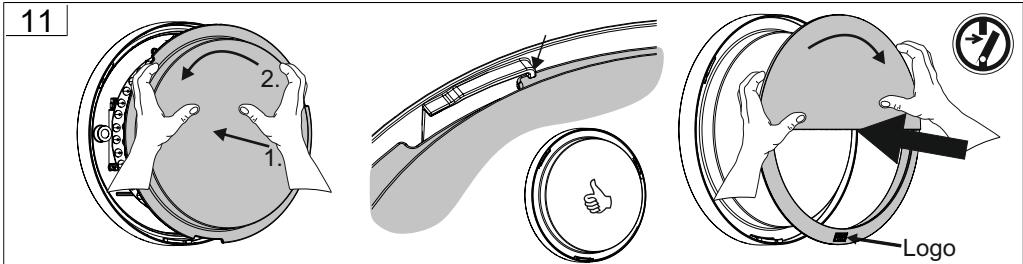

12

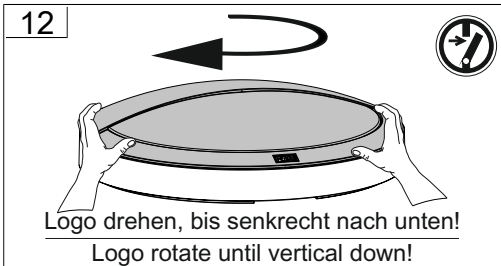

13

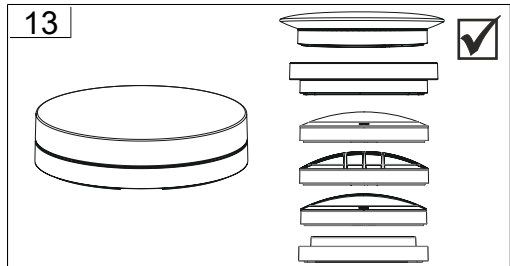

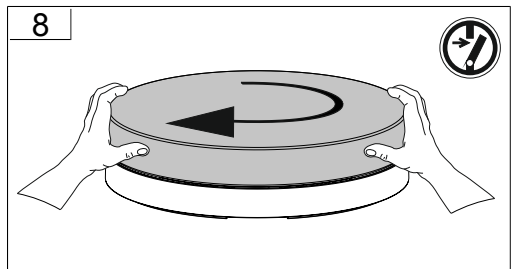
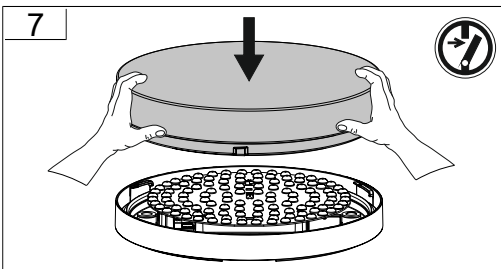
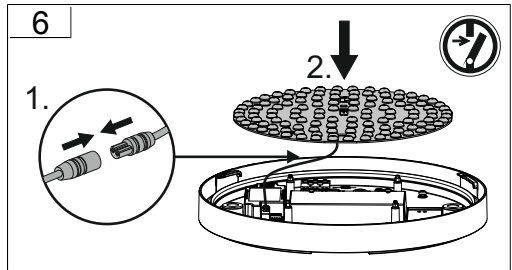
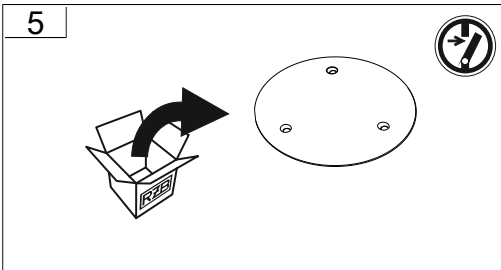
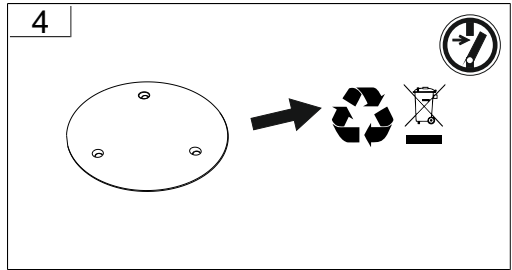
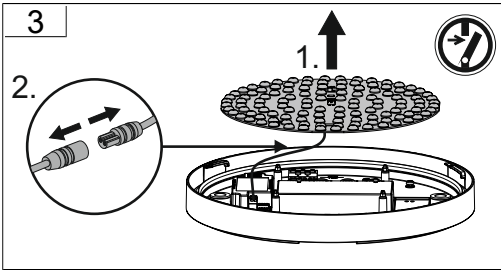
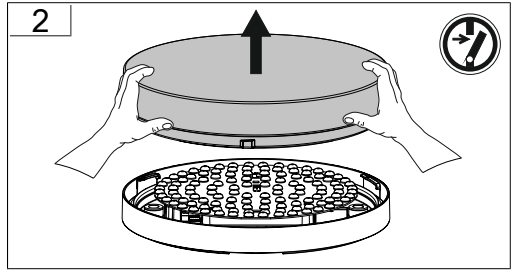
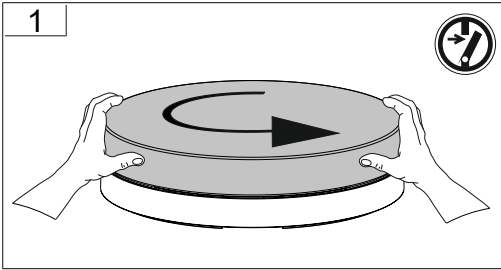



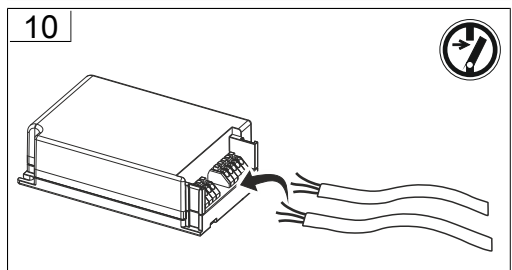
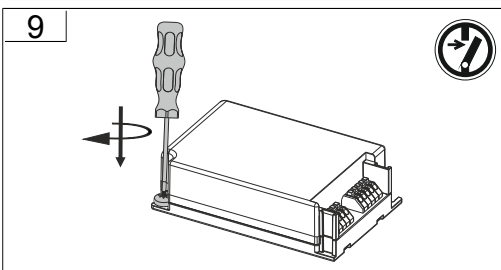
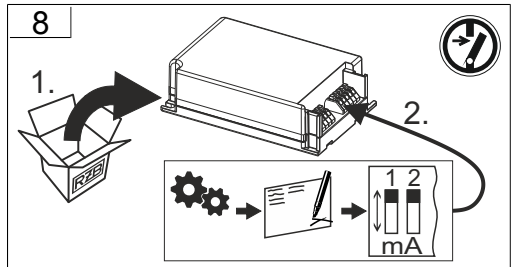
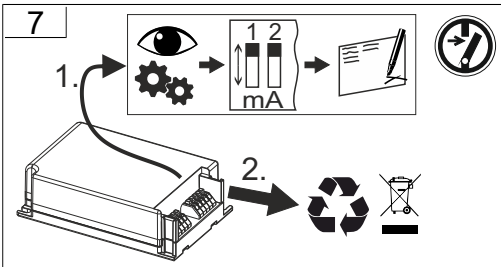
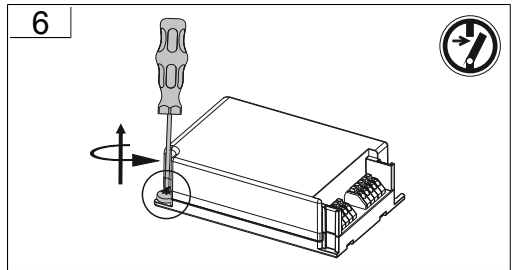
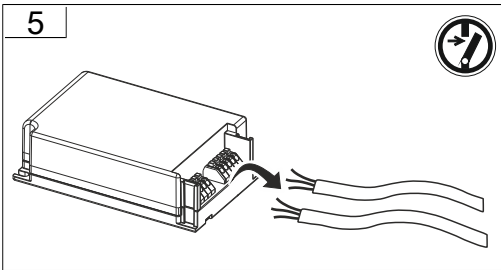
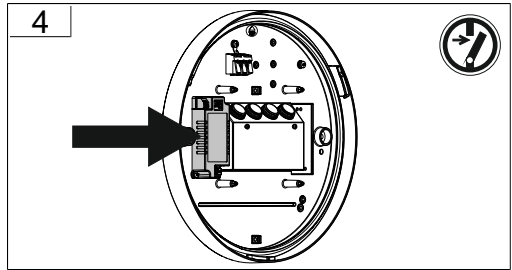
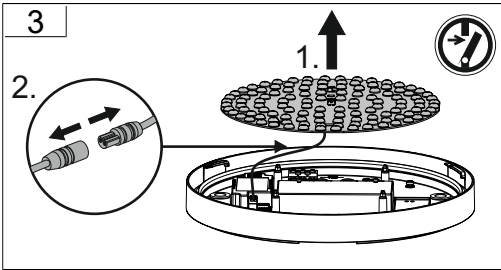
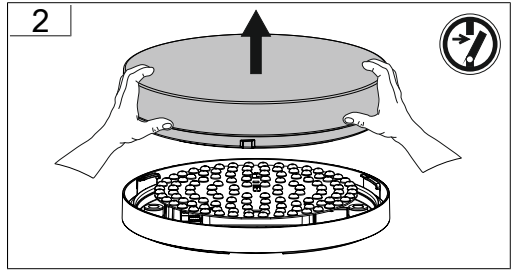
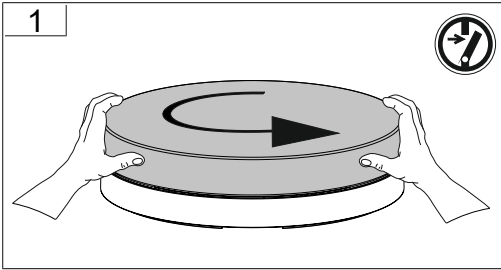

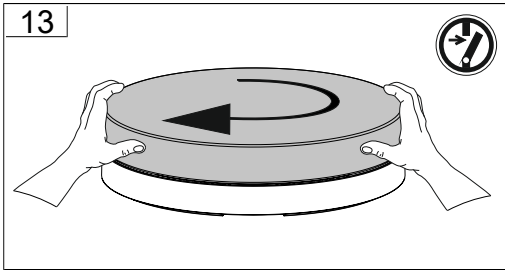
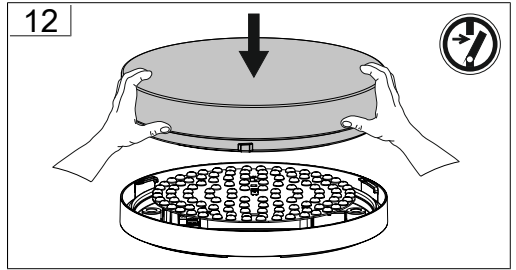
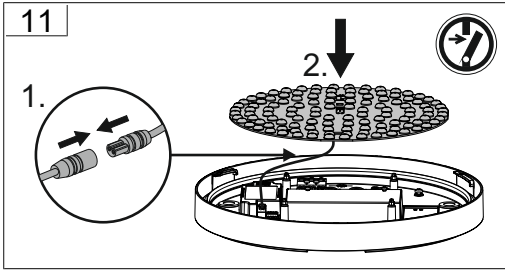

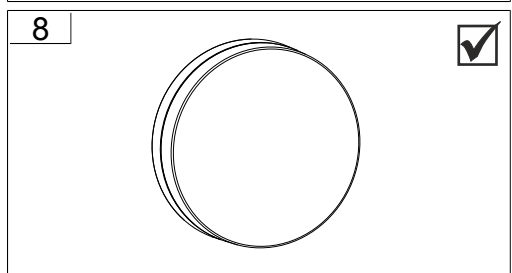
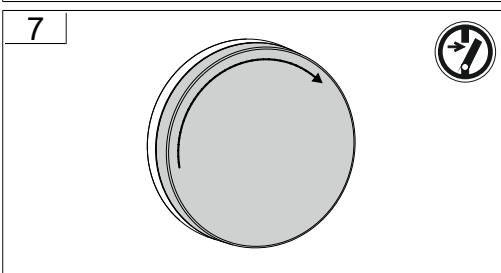
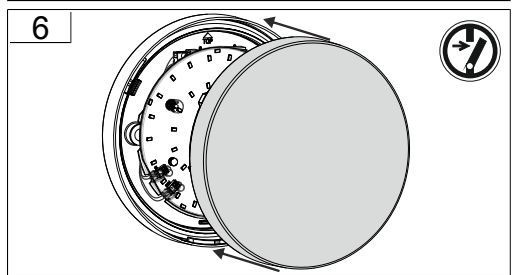
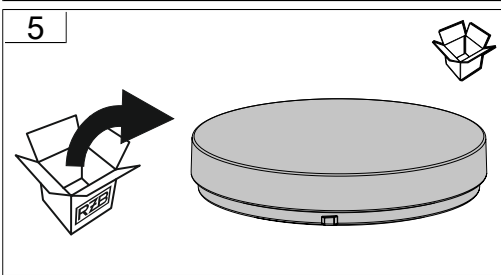
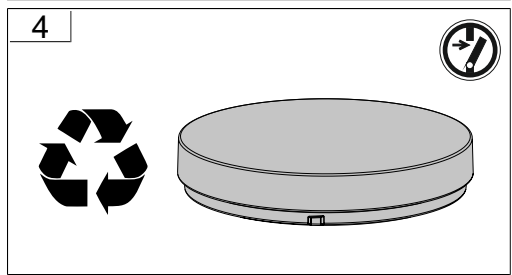
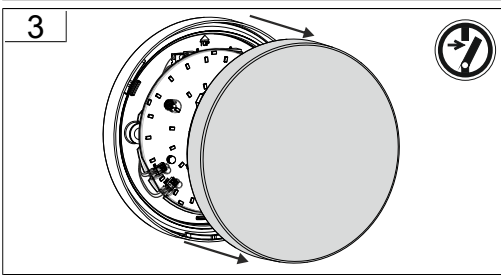
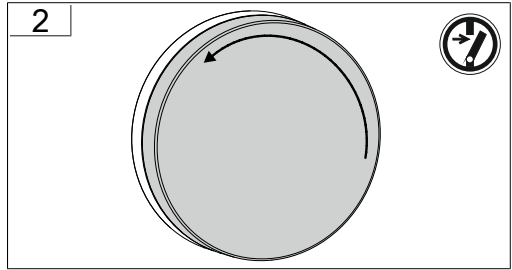
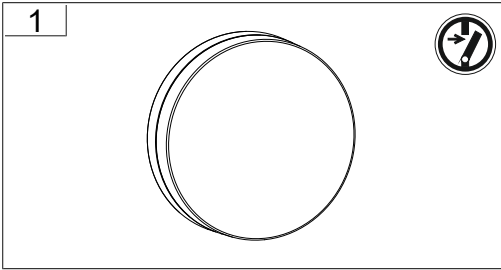

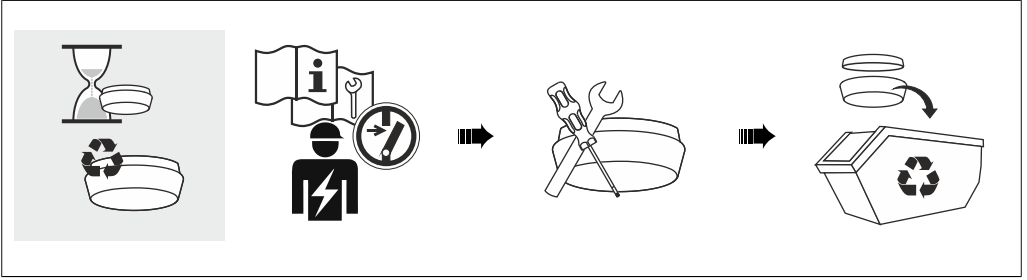
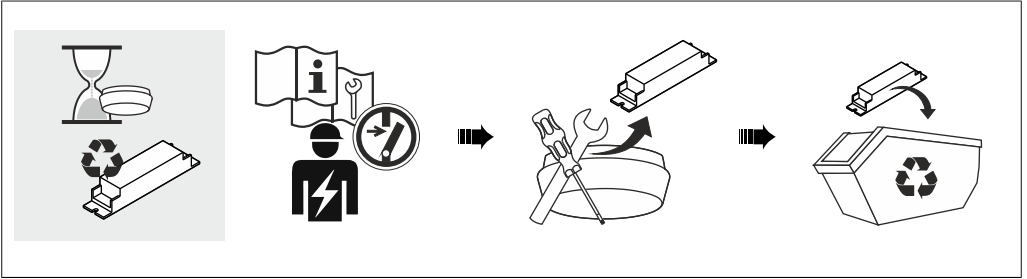
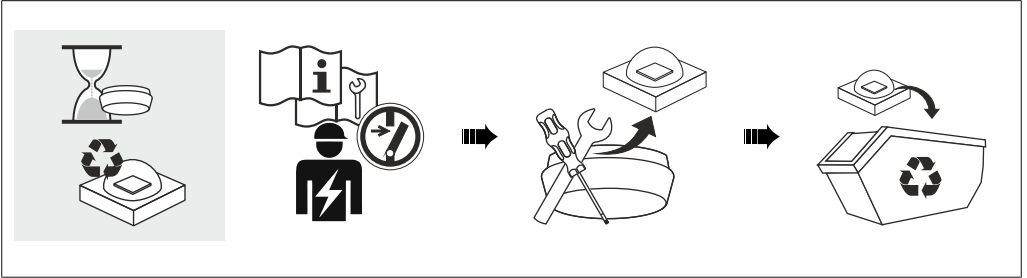







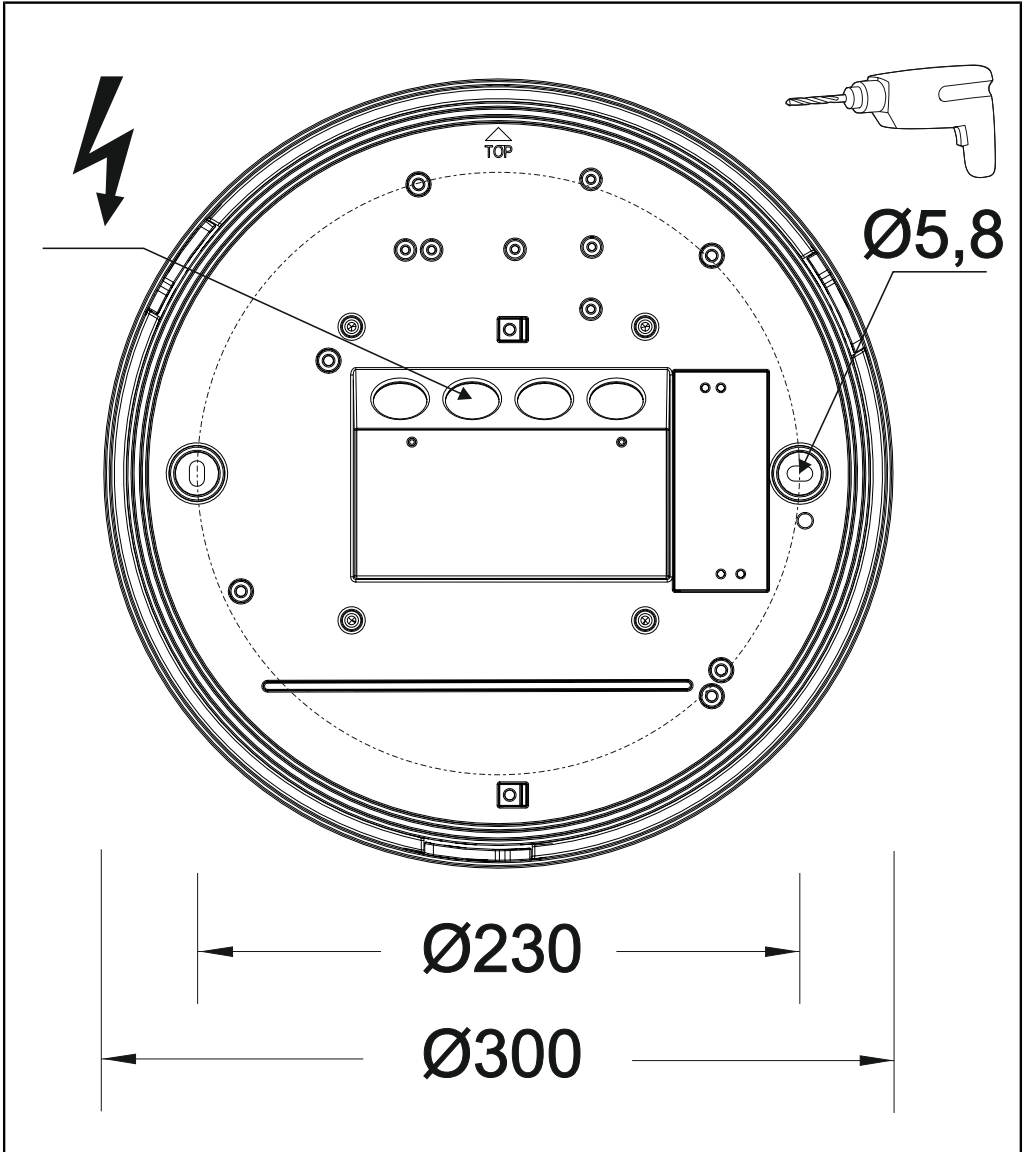





RZB - Rudolf Zimmermann, Bamberg GmbH

 Rheinstraße 16, 96052 Bamberg

 0951/7909-0

 0951/7909-198

 [info@rzb-leuchten.de](mailto:info@rzb-leuchten.de)