

INSTRUCTION

Trixy
901845.002

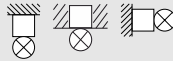

RZB
LIGHTING

~ 220 - 240 V 50/60 Hz IP 20 IK02



| | | | |
|---|--|--|--|
| <p>2 x 1,5 mm² 1,50 mm²</p> | | <p>Umgebungstemperatur / temperature ambiante => -20 °C ... + 40 °C</p> | |
|---|--|--|--|

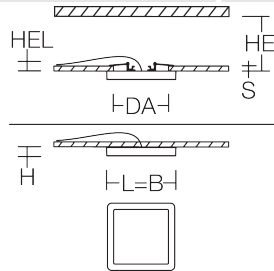

| | | |
|-------------|-------------|--|
| <p>[mm]</p> | <p>[mm]</p> | |
|-------------|-------------|--|

L 450, B 450, H 30, HEL 25

DA 150-400, HE 82, S 5-25

2,29 kg

| | | | | | | |
|------------|-------------|-------------------|-------------|--|--|--|
| <p>LED</p> | Φ [lm] | P_{\square} [W] | P_{\circ} | | | |
|------------|-------------|-------------------|-------------|--|--|--|

LED

4350

35

1 x 32 W

| | | | | | | |
|-----------|-------|------|-------|--|--|--|
| CCT [K] | CRI | RG | EEK | | | |
|-----------|-------|------|-------|--|--|--|

4000

80

RG 1

D

| | | | | | |
|--|------------------|------------------|------------------|------------------|--|
| <p>I_{max} / $I_{max}/2$ / t_{50}</p> | <p>B10 [St.]</p> | <p>B16 [St.]</p> | <p>C10 [St.]</p> | <p>C16 [St.]</p> | |
|--|------------------|------------------|------------------|------------------|--|

33,4 A / 282 μ s

7

12

12

20





Allgemeine Sicherheitshinweise

- Der elektrische Anschluss muss ordnungsgemäß nach geltenden Normen und den nationalen sowie internationalen Sicherheits- und Unfallverhütungsvorschriften erfolgen.
- Beschädigte Leuchten dürfen nicht betrieben werden.
- Keine Haftung für Schäden durch unsachgemäßen Einsatz.
- Bei Instandsetzung nur Originalteile verwenden.
- Tragfähigkeit der Decke und Befestigungselemente sicherstellen.

Betrieb der Leuchte

- Die unzulässigen Umgebungstemperaturen reduzieren die Lebensdauer der Leuchte, im Extremfall droht der Frühausfall.
- Zur Vermeidung von EMV-Problemen die Durchgangsverdrahtung nicht entlang der Leuchtenverdrahtung führen.
- Steuereingänge von dimmbaren Leuchten mit handelsüblichen für Netzspannung geeigneten Leitungen anschließen.

Manipulationen unserer Produkte sind unzulässig

Veränderung, Umarbeitung, Umkennzeichnung von Produkten sowie deren Verpackung sind unzulässig und verletzen u.a. unsere eingetragenen Warenzeichenrechte. Solche Modifikationen können technische Eigenschaften unserer Produkte negativ beeinflussen, diese zerstören und möglicherweise Folgeschäden an anderen Objekten verursachen. Für durch derartige Modifikationen verursachte Schäden kann der Hersteller in keinem Fall verantwortlich gemacht werden.



General Safety Information

- Electric connection must be appropriate according to all applicable standards and other national and international safety and accident prevention regulations.
- Damaged luminaires must not be operated.
- No liability is accepted for damages resulting from improper use.
- Use genuine parts only for repair.
- Ensure stability of the ceiling and fastening elements.

Operation of the luminaire

- Exceeding the permissible ambient temperature will reduce the luminaire's lifecycle, resulting in premature failure in extreme cases.
- Avoid ESD problems by not routing feed-through wiring directly along the wiring of the luminaire.
- Connect control inputs of dimmable luminaires with standard cables suitable for power supply voltage.

Manipulation of our products is not permitted

Modifications, reworking, re-labelling of products as well as their package is not permitted and infringes, amongst others, our registered trademark rights. Such modifications may affect technical properties of our products, damage them and possibly cause consequential damage to other objects. The manufacturer shall not be responsible under any circumstances for damage caused by such modifications.



Bei Fragen zu unseren Symbolen, besuchen Sie folgende Webseite:

If you have any questions about our signs, visit the following website:



https://www.rzb.de/fileadmin/assets/downloads/PDF/RZB_Symbolklaerung.pdf

EEK

Dieses Produkt enthält eine Lichtquelle der Energieeffizienzklasse D entsprechend Verordnung (EU) 2019/2015

This product contains a light source of energy efficiency class D according to regulation (EU) No 2019/2015

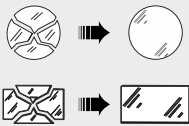

Jede zersprungene Schutzabdeckung ist zu ersetzen. DIN EN 60598

Replace any cracked protective shield. IEC DIN EN 60598



Die Lichtquelle dieser Leuchte ist nicht ersetzbar, wenn die Lichtquelle ihr Lebensdauerende erreicht hat, ist die gesamte Leuchte zu ersetzen. DIN EN 60598-1 / IEC 60598-1

The light source of this luminaire is not replaceable, when light source reaches its end of life the whole luminaire shall be replaced. DIN EN 60598-1 / IEC 60598-1

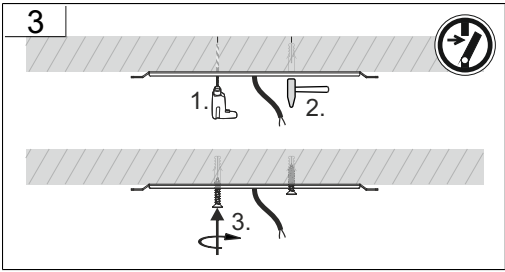
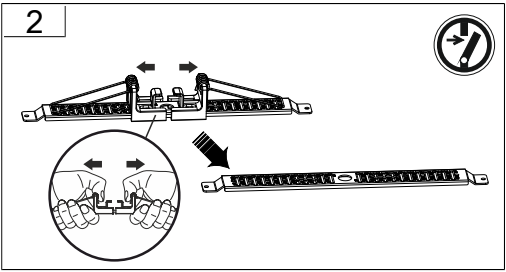
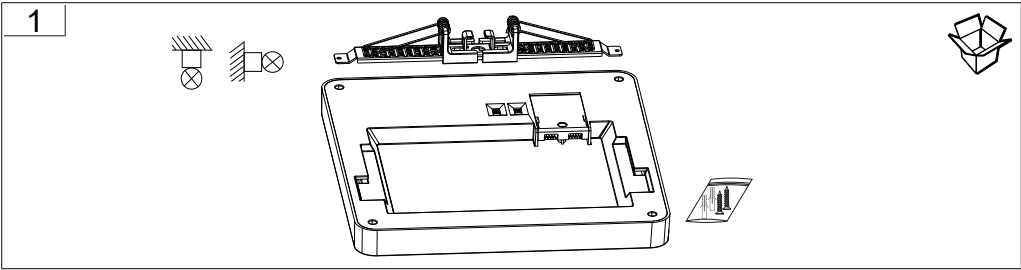

4

| | P_{LED} [W] | CCT [K] WW=3000 | CCT [K] NW=4000 |
|------|----------------------|--------------------|--------------------|
| 25 W | 25 | 3000 lm | 3150 lm |
| 30 W | 30 | 3600 lm | 3800 lm |
| 35 W | 35 | 4200 lm | 4350 lm |

WW NW

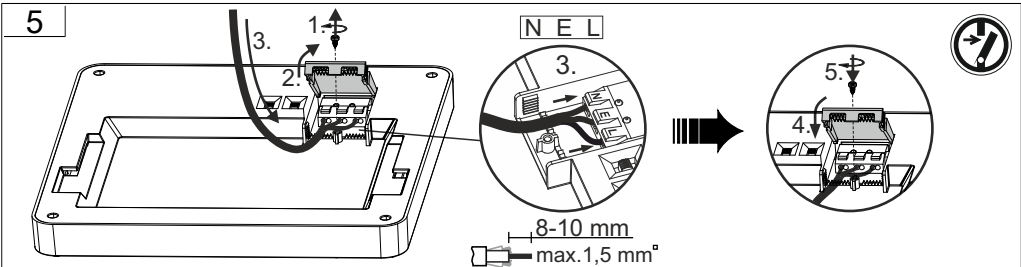

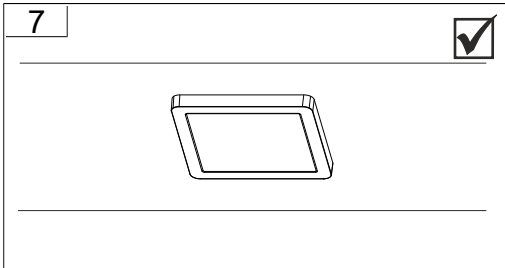
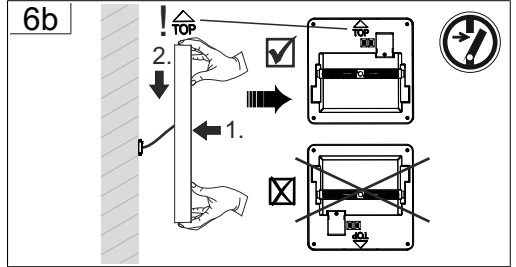
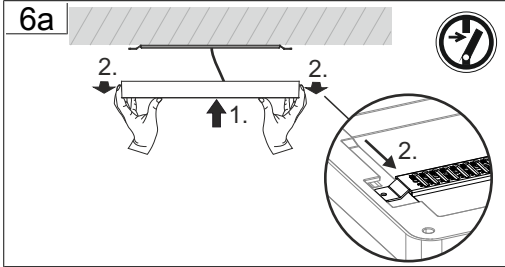



1

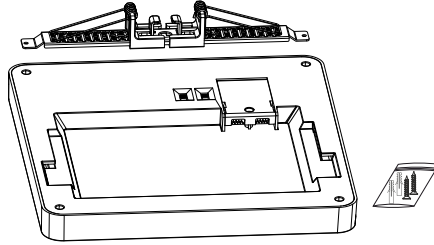

2

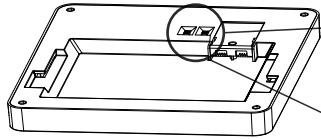

NW ↑

WW ↓

Wattage ↑

↓

| | P_{max} [W] | CCT [K] WW=3000 | CCT [K] NW=4000 |
|------|----------------------|--------------------|--------------------|
| 25 W | 25 | 3000 lm | 3150 lm |
| 30 W | 30 | 3600 lm | 3800 lm |
| 35 W | 35 | 4200 lm | 4350 lm |

WW NW

3

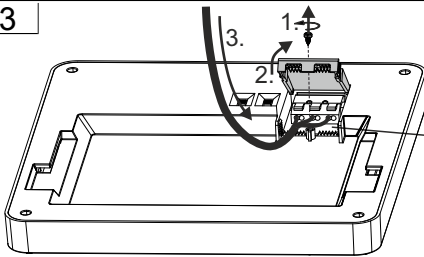

N E L

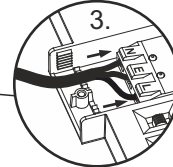

8-10 mm

max. 1,5 mm²

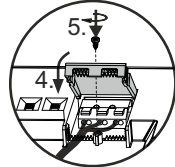

4

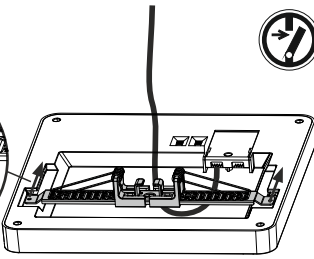
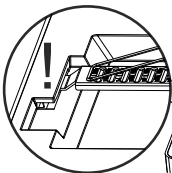



5

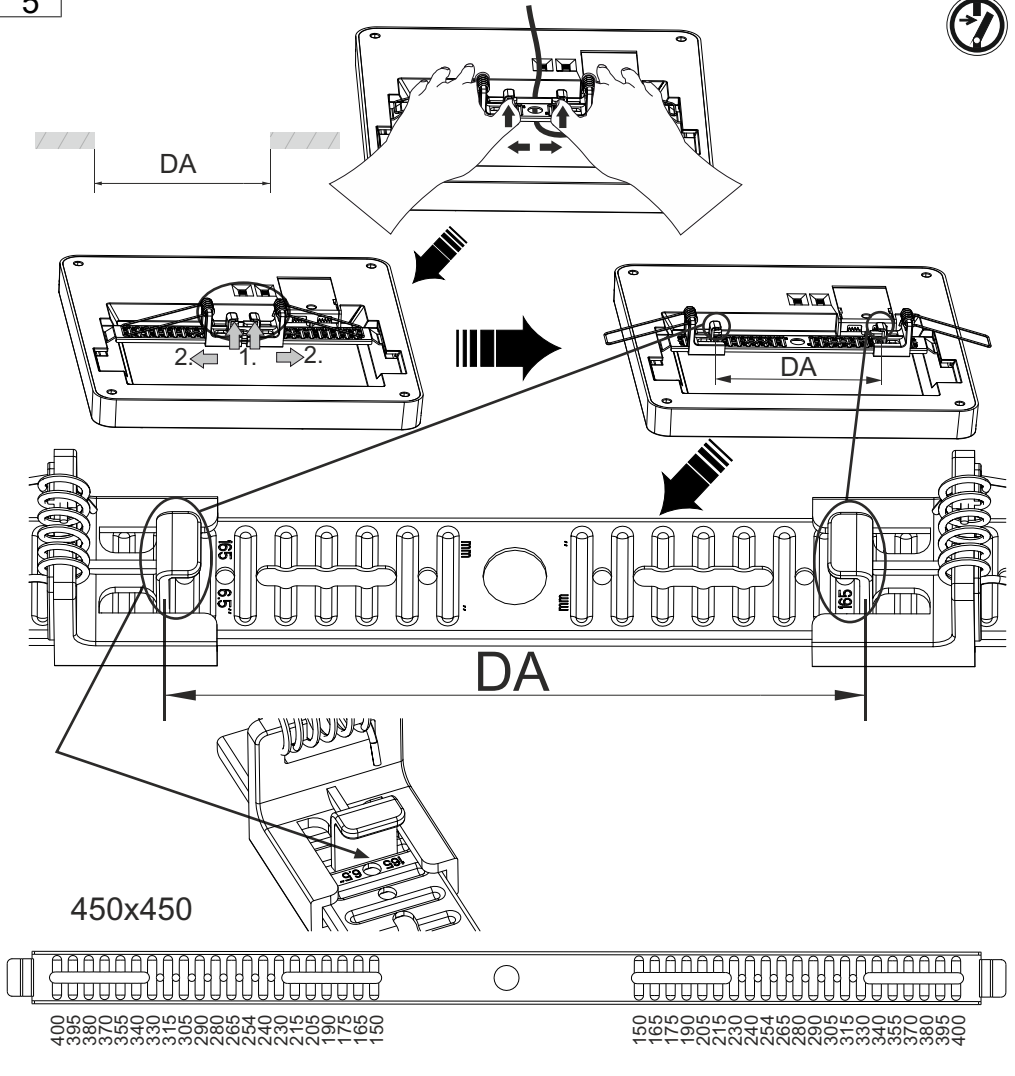

450x450

6

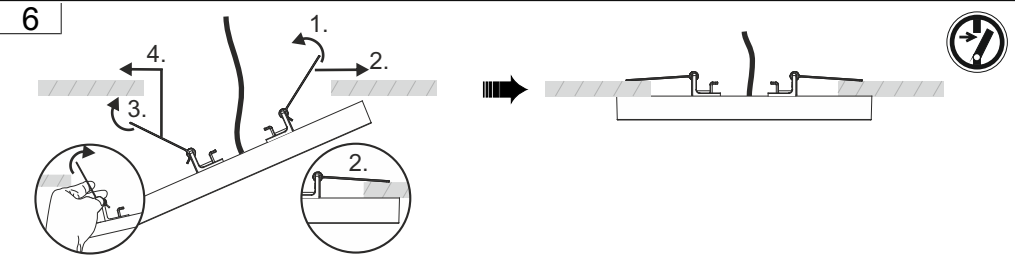



7

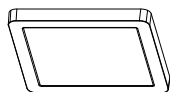

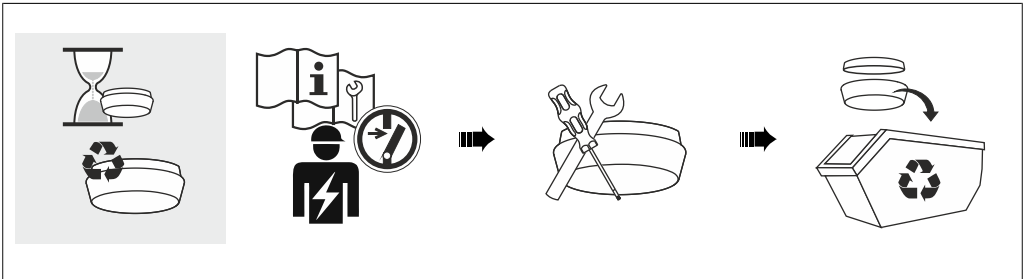
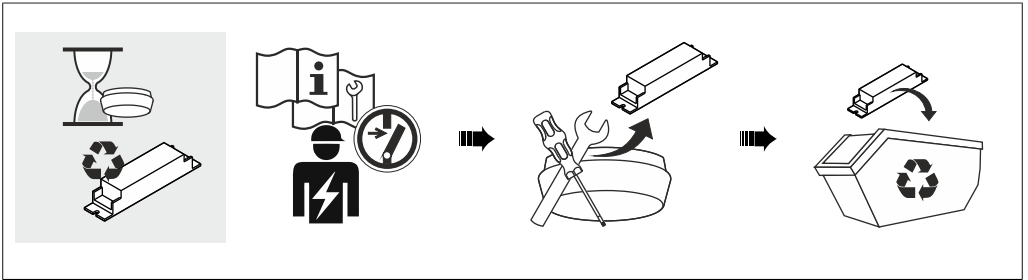
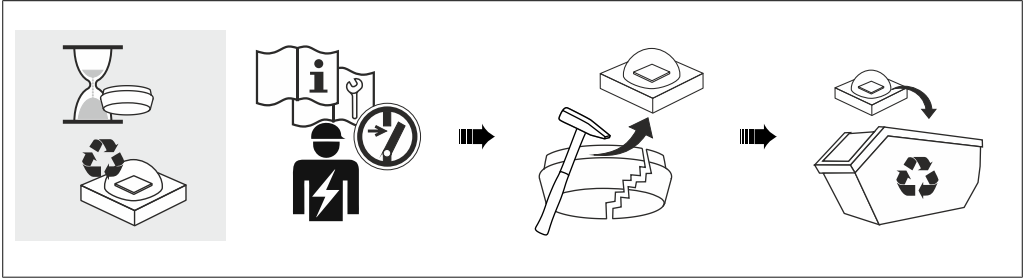





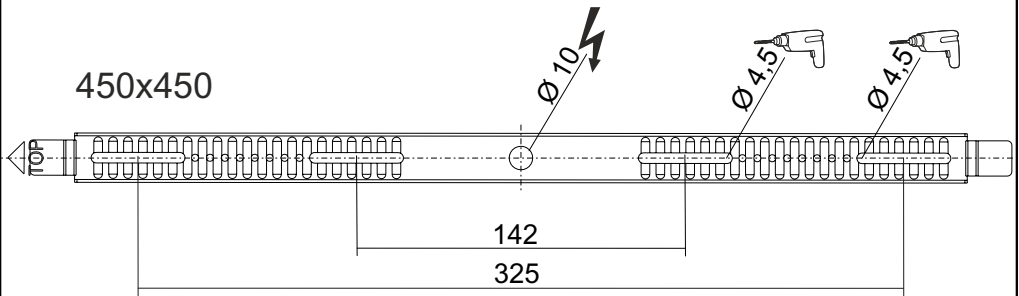

Anbau / surface mounted



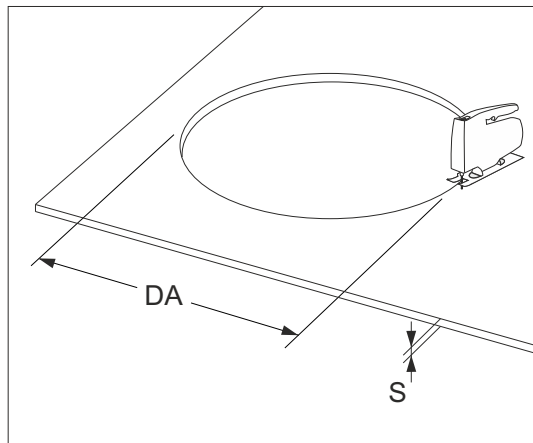

Einbau / recessed into ceiling



RZB - Rudolf Zimmermann, Bamberg GmbH

 Rheinstraße 16, 96052 Bamberg

 0951/7909-0

 0951/7909-198

 info@rzb-leuchten.de