

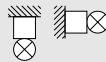

INSTRUCTION

Toledo Flat
672271.002.1



~ 100 - 240 V 50/60 Hz IP 40 IK06





 4 x 1,5 mm²

 2,50 mm²



 Dauerschaltung / maintained
=> 0 °C ... + 30 °C
Bereitschaftsschaltung / non
maintained
=> 5 °C ... + 30 °C

 3 h
 LiFePo4
3,2 V - 4,5 Ah

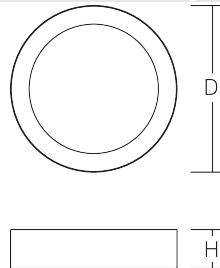

D 257, H 63

2,56 kg



Φ  [lm]

P  [W]

Φ  [lm]

P 

LED

1650

20

460

1 x 18 W

CCT [K]

CRI

RG 

EEK 

4000

80

RG 0

D



 B10
[St.]

 B16
[St.]

 C10
[St.]

 C16
[St.]

COS φ

7 A / 100 μ s

32

51

32

51

0,9





Allgemeine Sicherheitshinweise

- Der elektrische Anschluss muss ordnungsgemäß nach geltenden Normen und den nationalen sowie internationalen Sicherheits- und Unfallverhütungsvorschriften erfolgen.
- Beschädigte Leuchten dürfen nicht betrieben werden.
- Keine Haftung für Schäden durch unsachgemäßen Einsatz.
- Bei Instandsetzung nur Originalteile verwenden.
- Tragfähigkeit der Decke und Befestigungselemente sicherstellen.

Betrieb der Leuchte

- Die unzulässigen Umgebungstemperaturen reduzieren die Lebensdauer der Leuchte, im Extremfall droht der Frühausfall.
- Zur Vermeidung von EMV-Problemen die Durchgangsverdrahtung nicht entlang der Leuchtenverdrahtung führen.
- Steuereingänge von dimmbaren Leuchten mit handelsüblichen für Netzspannung geeigneten Leitungen anschließen.

Manipulationen unserer Produkte sind unzulässig

Veränderung, Umarbeitung, Umkennzeichnung von Produkten sowie deren Verpackung sind unzulässig und verletzen u.a. unsere eingetragenen Warenzeichenrechte. Solche Modifikationen können technische Eigenschaften unserer Produkte negativ beeinflussen, diese zerstören und möglicherweise Folgeschäden an anderen Objekten verursachen. Für durch derartige Modifikationen verursachte Schäden kann der Hersteller in keinem Fall verantwortlich gemacht werden.



General Safety Information

- Electric connection must be appropriate according to all applicable standards and other national and international safety and accident prevention regulations.
- Damaged luminaires must not be operated.
- No liability is accepted for damages resulting from improper use.
- Use genuine parts only for repair.
- Ensure stability of the ceiling and fastening elements.

Operation of the luminaire

- Exceeding the permissible ambient temperature will reduce the luminaire's lifecycle, resulting in premature failure in extreme cases.
- Avoid ESD problems by not routing feed-through wiring directly along the wiring of the luminaire.
- Connect control inputs of dimmable luminaires with standard cables suitable for power supply voltage.

Manipulation of our products is not permitted

Modifications, reworking, re-labelling of products as well as their package is not permitted and infringes, amongst others, our registered trademark rights. Such modifications may affect technical properties of our products, damage them and possibly cause consequential damage to other objects. The manufacturer shall not be responsible under any circumstances for damage caused by such modifications.



Bei Fragen zu unseren Symbolen, besuchen Sie folgende Webseite:

If you have any questions about our signs, visit the following website:



https://www.rzb.de/fileadmin/assets/downloads/PDF/RZB_Symbolklaerung.pdf

EEK

Dieses Produkt enthält eine Lichtquelle der Energieeffizienzklasse D entsprechend Verordnung (EU) 2019/2015

This product contains a light source of energy efficiency class D according to regulation (EU) No 2019/2015

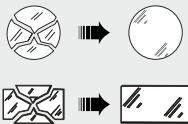

Jede zersprungene Schutzabdeckung ist zu ersetzen. DIN EN 60598

Replace any cracked protective shield. IEC DIN EN 60598



Die Lichtquelle dieser Leuchte ist nicht ersetzbar, wenn die Lichtquelle ihr Lebensdauerende erreicht hat, ist die gesamte Leuchte zu ersetzen. DIN EN 60598-1 / IEC 60598-1

The light source of this luminaire is not replaceable, when light source reaches its end of life the whole luminaire shall be replaced. DIN EN 60598-1 / IEC 60598-1



Zur Verwendung in Anlagen nach EN 50172 / DIN VDE 0108-100

For installation according to EN-50172 / DIN VDE 0108-100



Die Sicherheitsleuchten werden generell mit entladenen oder teilentladenen Akkus ausgeliefert und müssen für die volle Funktionstüchtigkeit die vorgegebene Inbetriebnahme durchlaufen.

The emergency luminaires are delivered with either discharged or only partially charged batteries and run through the specified commissioning before reaching their fully operability.



Einteilung Notleuchten

| | | | |
|---|----|-----|------|
| * | ** | *** | **** |
|---|----|-----|------|

Veränderungen am Auslieferungszustand der Leuchte sind gemäß DIN EN 60598-2-22 auf dem Typenschild zu kennzeichnen.

Classification Emergency Lighting

| | | | |
|---|----|-----|------|
| * | ** | *** | **** |
|---|----|-----|------|

Modifications to the delivery condition of the luminaire must be documented on the product label accordingly to IEC 60598-2-22.

| * | Typ (1-stellig) | Type (1-digit) |
|---|-----------------|----------------|
| X | Einzelbatterie | Self-Contained |
| Z | Zentralbatterie | Central Supply |

| ** | Betriebsart (1-stellig) | Operating Mode (1-digit) |
|----|--|--|
| 0 | Notleuchte Bereitschaftsschaltung | Emergency Lighting non-maintained |
| 1 | Notleuchte Dauerschaltung | Emergency Lighting maintained |
| 2 | Kombinierte Notleuchte Bereitschaftssch. | Combi. Emergency Lighting non-maintained |
| 3 | Kombinierte Notleuchte Dauerschaltung | Combined Emergency Lighting maintained |

| *** | Einrichtungen (max. 7-stellig) | Installation (max. 7-digit) |
|-----|--|---------------------------------------|
| A | manuelle Prüfeinrichtung | Manual Test Device |
| B | Fernschalter für Ruhe-Zustand | Including Remote Rest Mode |
| C | Fernausschaltemöglichkeit | Including Inhibiting Mode |
| D | Arbeitsstätten m. besonderer Gefährdung | High-Risk Task-Area Luminaire |
| E | Lampe oder Batterie nicht austauschbar | With non-replaceable Lamps or Battery |
| F | automatische Prüfeinrichtung | Automatic Test Device |
| G | von innen beleuchtetes Sicherheitszeich. | Inside illuminated safety sign |

| **** | Betriebsdauer (2/3-stellig) (nur bei Einzelbatterie) | Duration Time (2/3-digit) (only for self-contained) |
|------|---|--|
| 60 | Betriebsdauer 60 Minuten | Duration Time 60 Minutes |
| 180 | Betriebsdauer 180 Minuten | Duration Time 180 Minutes |
| 480 | Betriebsdauer 480 Minuten | Duration Time 480 Minutes |



Anschlussplan / Wiring diagram

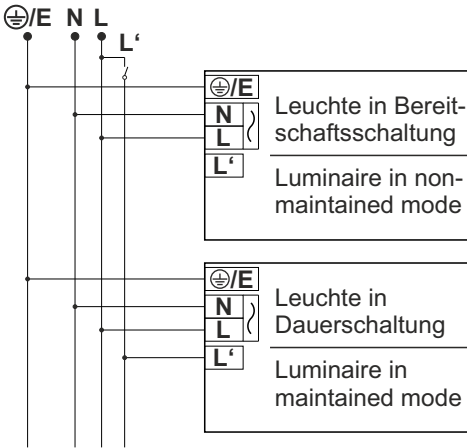

| | |
|-----------|---|
| | Schutzleiter (SK I) // Ground Wire (IC I) |
| E | Erdung (SK II) // earthing (IC II) |
| N | Nullleiter // Neutral Wire |
| L | Dauerphase // Duration Wire |
| L' | <u>Geschaltete Phase für Dauerschaltung</u> Connected phase for maintained operation |

Funktionsanzeige LED / Indicator LED

| | | |
|--|---|--|
|  | <u>intermittierend grün (8s)</u> <u>intermittently green (8s)</u> | <u>Akku Regenerierung</u> <u>battery regeneration</u> |
|  | <u>permanent grün</u> <u>permanently green</u> | <u>keine Störung</u> <u>no fault</u> |
|  | <u>permanent rot blinkend</u> <u>continously flashing red</u> | <u>Fehler Akku</u> <u>battery fault</u> |
|  | <u>intermittierend rot blinkend</u> <u>intermittently flashing red</u> | <u>Fehler Leuchtmittel</u> <u>luminaire fault</u> |
|  | <u>dunkel</u> <u>dark</u> | <u>Notbetrieb / kein Netz</u> <u>emergency operation / no mains</u> |

Kontrolle nach der Installation

30 Minuten nach der Inbetriebnahme muss die Status-LED grün leuchten. Wenn die LED nicht leuchtet, ist die Ladung durch fehlende Netzspannung, unterbrochene Leitung zum Akku oder defekte Ladeinheit nicht gewährleistet.

Optimierung der Lebensdauer des Akkus

Bei jeder Inbetriebnahme bzw. jedem Akkuwechsel wird ein Regenerierungsverfahren ausgeführt. Das Verfahren dauert ca. 3 - 4 Tage. Erst danach ist die Leuchte uneingeschränkt einsatzbereit.

Dauertests

Der erste Dauertest erfolgt ca. 8 Tage nach dem Regenerierungsverfahren. Dieser wird alle 12 Wochen durchgeführt, um die Lebensdauer der Akkus zu optimieren.

Prüfungen

Einzelbatterieleuchten sind gemäß der Vorschriften am Montageort zu testen. Mängel sind sofort zu beheben. Prüfergebnisse sind im Prüfbuch zu dokumentieren.

Quittieren

Wenn beim Test Fehler auftreten, werden diese durch die farbige Status LED an der Leuchte angezeigt. Um die Fehleranzeige nach Behebung des Fehlers zurückzusetzen, muss die Versorgungsspannung der Leuchte kurzfristig abgeschaltet werden.

Check after installation

30 minutes after start up must the green LED on. If the LED is off, it must be detected that the charging is not inhibited due to a missing voltage supply, due to a lineinterruption to the battery or due to a faulty electronic.

Optimizing the lifetime of the battery

With every start up or battery change a regeneration process will be performed. The process takes a time of 3 until 4 days. After that the luminaire is absolutely ready for use.

Endurance test

The first duration test occurs after 8 days after the regeneration process. This one will carried out every 12 weeks, to optimize the battery life.

Tests

Self-contained luminaires had to tested at their mounting location in compliance with the regulations. Any defects have to be repaired immediately. Test results need to noted.

Acknowledging error status

If failure will displayed, these are indicated by colored status LED on luminaire. Reset the error status after testing, the luminaire has to be disconnected from mains voltage temporarily.

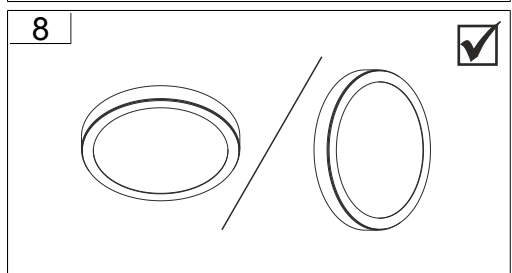
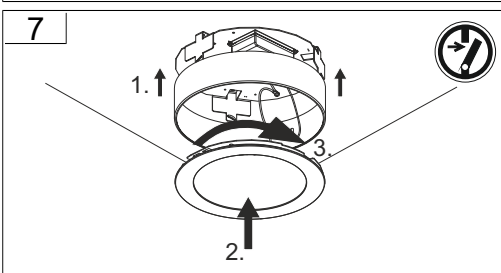
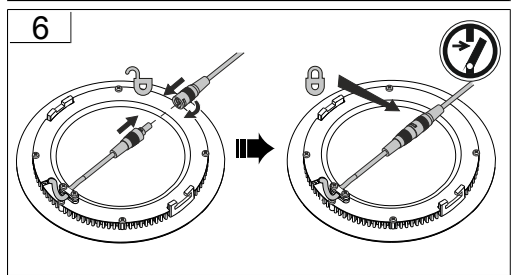
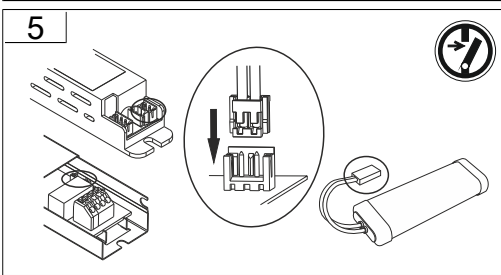
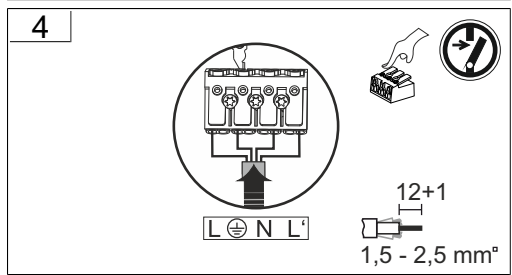
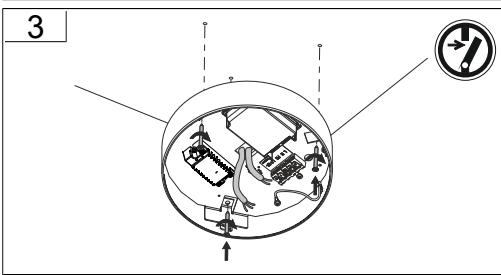
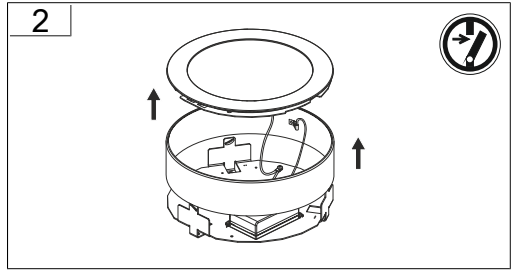
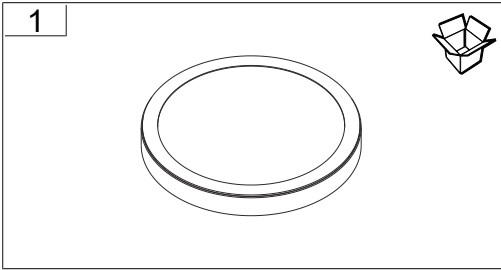
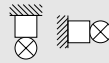

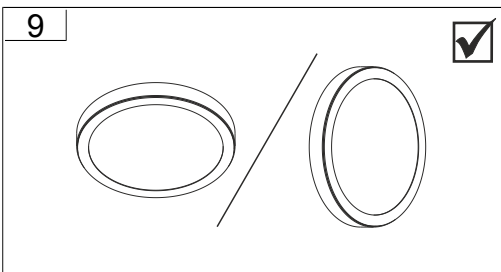
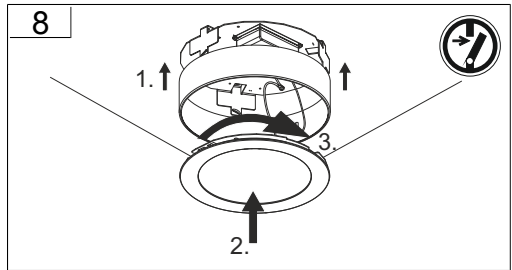
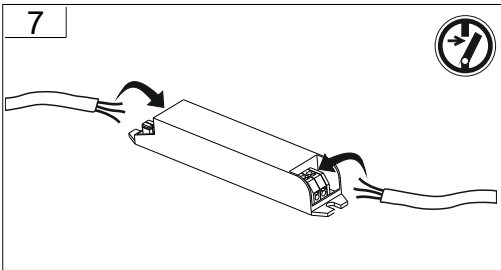
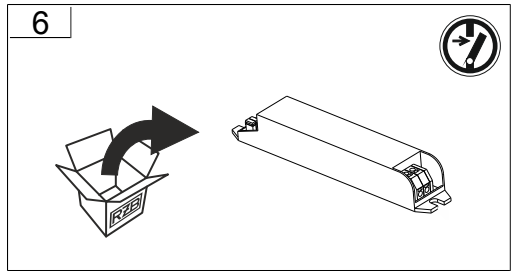
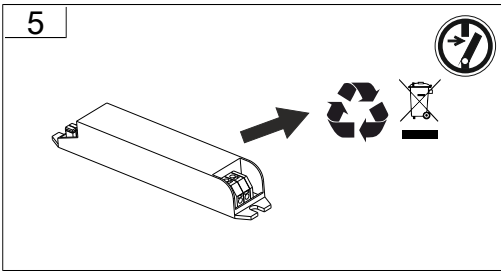
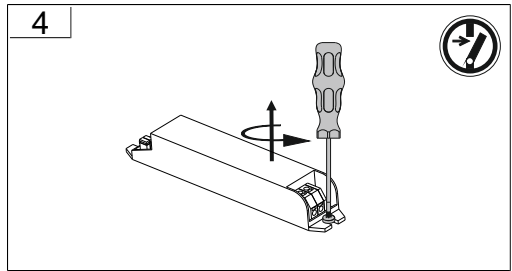
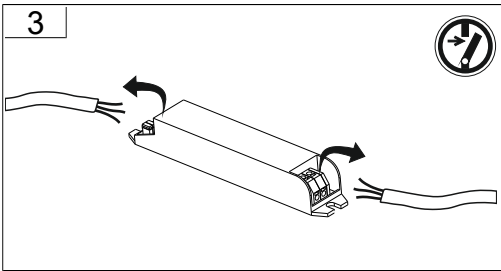
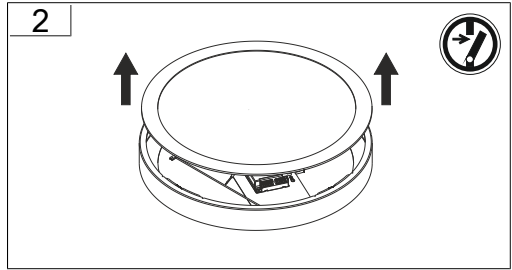
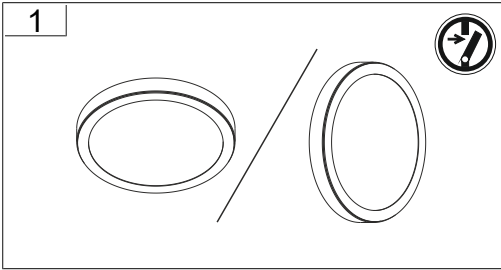

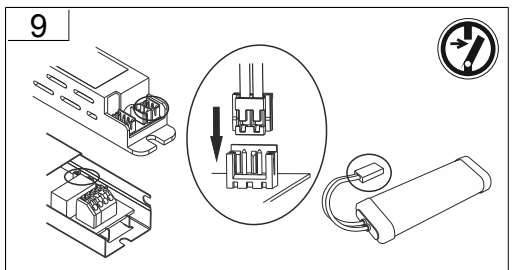
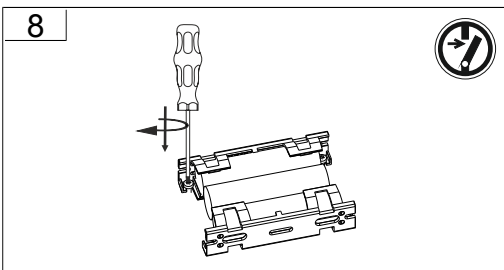
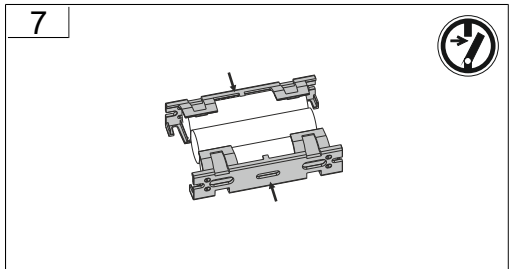
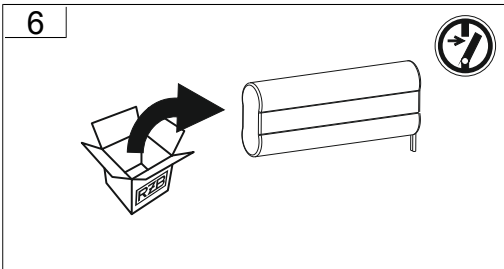
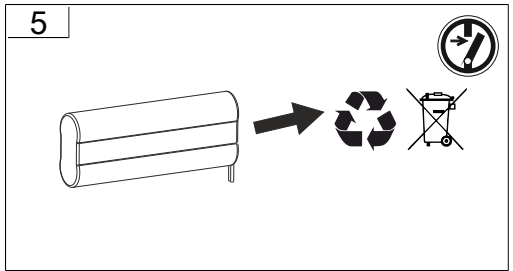
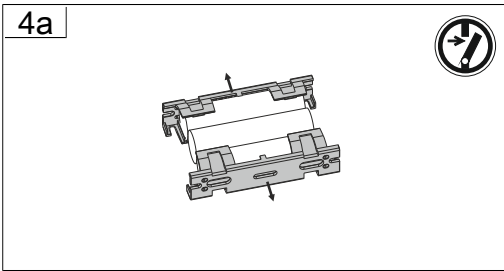
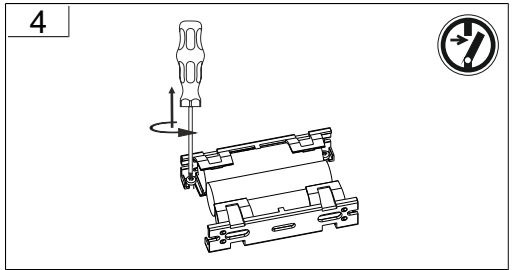
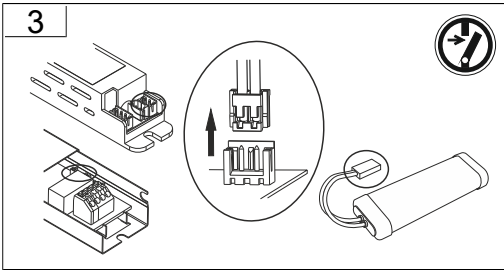
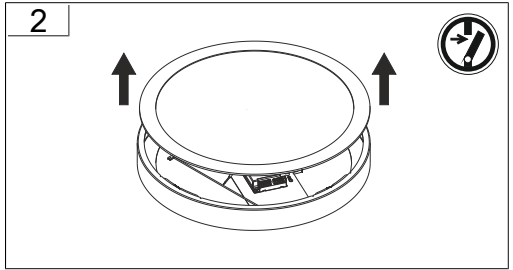
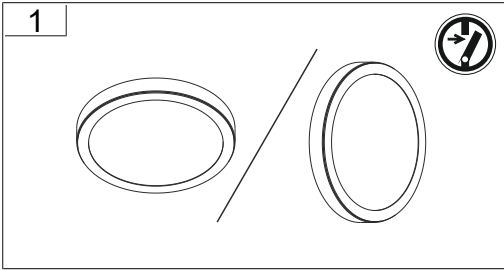

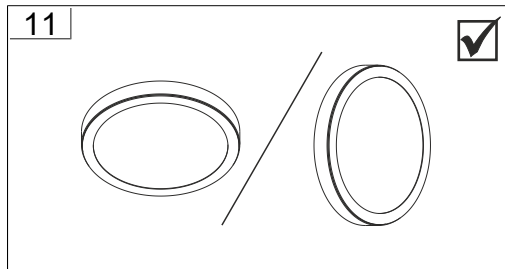
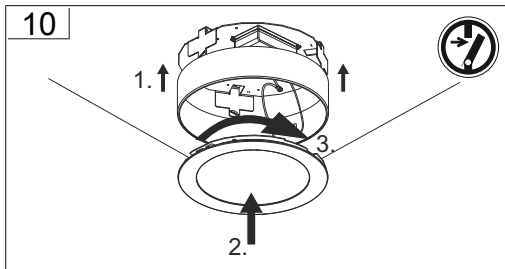
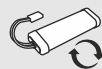

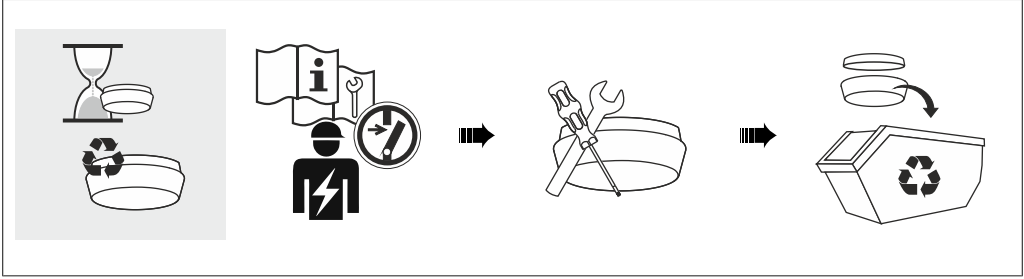
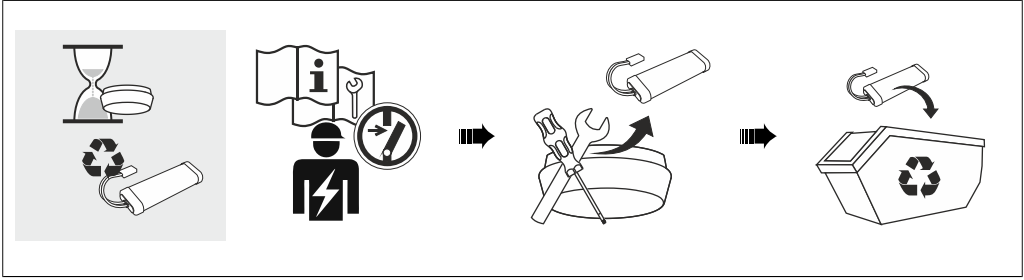
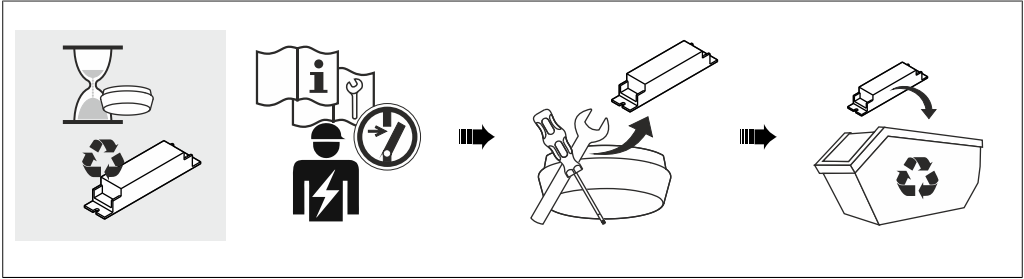
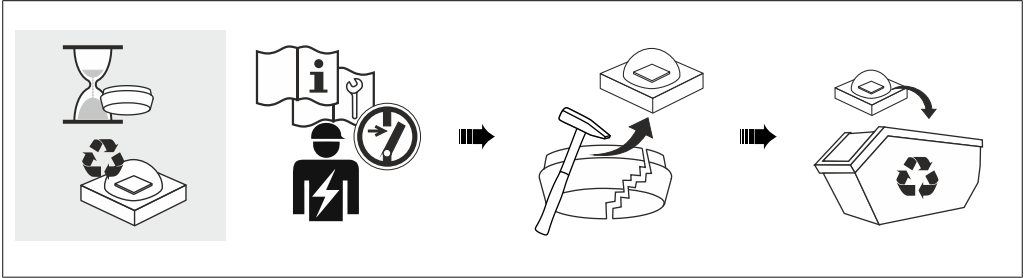







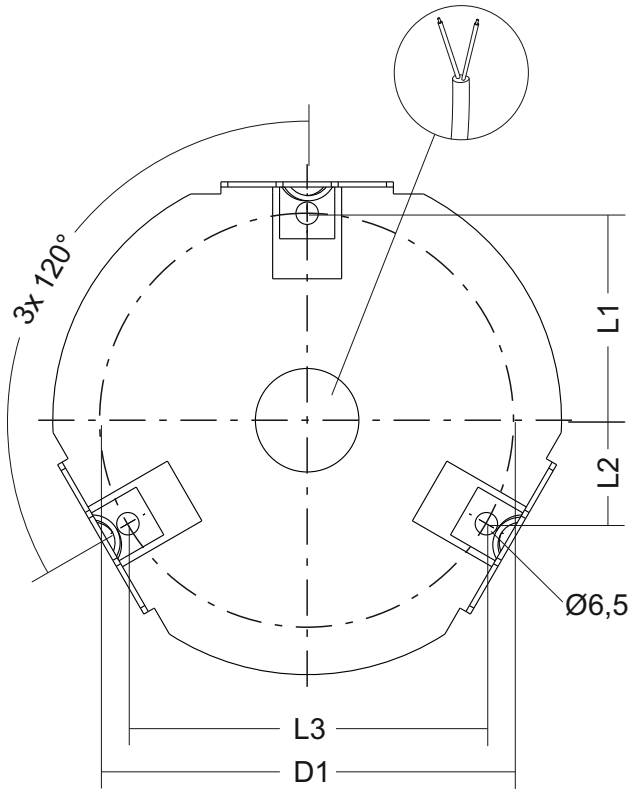

| Toledo Flat Anbauleuchten | L1 | L2 | L3 | D1 |
|---------------------------|-------|------|-------|------|
| 672271.002.X.XX | 113,5 | 56,8 | 196,6 | Ø227 |
| 672272.002.X.XX | 113,5 | 56,8 | 196,6 | Ø227 |
| 672273.002.X.XX | 137,5 | 68,8 | 238,2 | Ø275 |
| 672274.002.X.XX | 137,5 | 68,8 | 238,2 | Ø275 |

RZB - Rudolf Zimmermann, Bamberg GmbH

Rheinstraße 16, 96052 Bamberg

0951/7909-0

0951/7909-198

info@rzb-leuchten.de