

KNX SYSTEM



USER
MANUAL



Presentation of the KNX offer	5
Composition	5
Architecture	6
Topology	7
Wiring topology	9
ETS software	10
Device presentation and installation	11
KNX control units	11
A. Simple control units	11
1. Range	11
2. Technical characteristics	12
3. Communication objects	12
B. Touch control units	12
1. Range	12
2. Technical characteristics	12
3. Communication objects	12
C. Touch screen	13
1. Range	13
2. Technical characteristics	13
3. Communication objects	13
KNX thermostats	14
1. Range	14
2. Technical characteristics	14
3. Communication objects	14
Ceiling-mounted or wall-mounted KNX detectors	15
1. Range	15
2. Technical characteristics	16
3. Communication objects	16
Radio control units	17
1. Range	17
2. Technical characteristics	17
3. Communication objects	17

Controllers	18
A. Ceiling-mounted KNX controllers	18
1. Range.....	18
2. Technical characteristics.....	18
3. Communication objects.....	18
B. Multi-application modular controllers	19
1. Range.....	19
2. Technical characteristics.....	19
3. Communication objects.....	20
C. ON/OFF controllers 002661/62.....	21
1. Range.....	21
2. Technical characteristics.....	21
3. Communication objects.....	21
D. ON/OFF controllers 002680/81/82	22
1. Range.....	22
2. Technical characteristics.....	22
3. Communication objects.....	22
E. Modular dimming controllers.....	23
1. Range.....	25
2. Technical characteristics.....	25
3. Communication objects.....	25
F. Roller shutter controller.....	26
1. Range.....	26
2. Technical characteristics.....	26
3. Communication objects.....	26
BUS/KNX interface input modules	27
1. Range.....	27
2. Technical characteristics.....	27
3. Communication objects.....	28

Infrastructure devices	29
A. USB interface	29
1. Range	29
2. Technical characteristics	29
3. Operating principle	29
B. KNX power supplies	29
1. Range	29
2. Technical characteristics	29
C. Line coupler	30
1. Range	30
2. Technical characteristics	30
3. Operating principle	30
D. IP communication module	30
1. Range	31
2. Technical characteristics	31
3. Communication objects	31
E. KNX cables	32
1. Range	32
2. Technical characteristics	32
F. Accessories and connector	32
KNX projects	33
Introduction	33
Installation	34
A. Marking up Legrand product IDs	34
1. Mark up the labels	34
2. Identify the information	34
B. Checking the installation wiring	36
1. Power up the equipment	36
2. Check the wiring of the peripheral devices (detectors, control units, etc.)	36
3. Check the wiring of the lighting lines	36
ETS configuration	37
Appendix	41

Presentation of the KNX offer

Composition

Legrand's KNX offer is used to create flexible, open installations.

The Legrand KNX lighting management system consists of the following assemblies:

Sensors: These can be manual (wiring accessories) or automatic (detectors). They send commands to the various system components.

Controllers (also called actuators): These receive commands from the system control units or automation devices. They have different outputs and control lighting or shutter loads.

Infrastructure devices: These power, connect and interface with the various lighting management system components or interface with other systems.

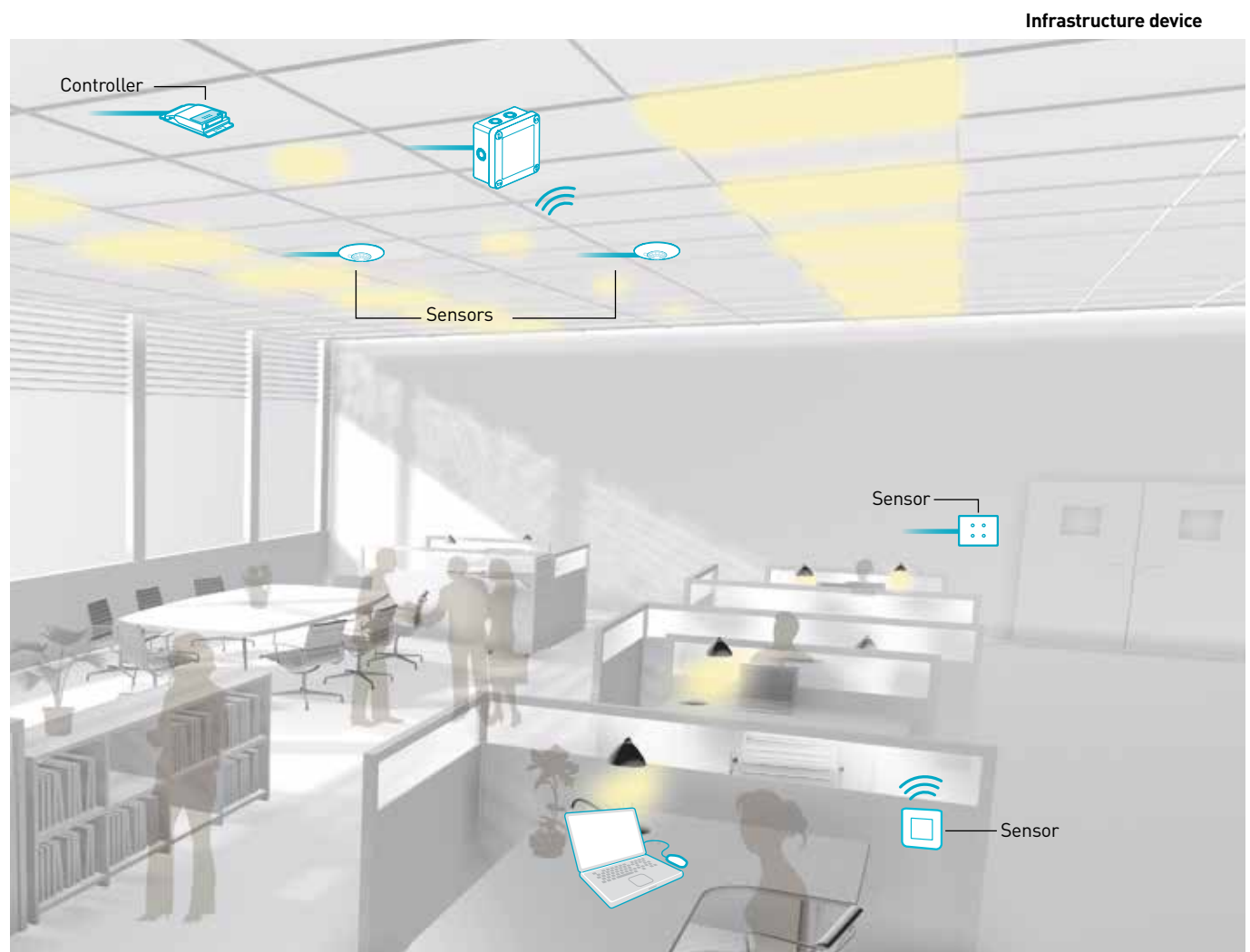

Presentation of the KNX offer (continued)

Architecture

The architecture of the KNX offer is based on 3 levels:

Integration level

Comprising the IP network, this level represents the interface with other building automation systems; it is based on the TCP/IP protocol.

Automation level

Comprising the actuators, this level interconnects the various devices in the installation and allows them to communicate (sends commands to the different actuators).

Field level

Comprising the sensors, this level involves interaction with the user.

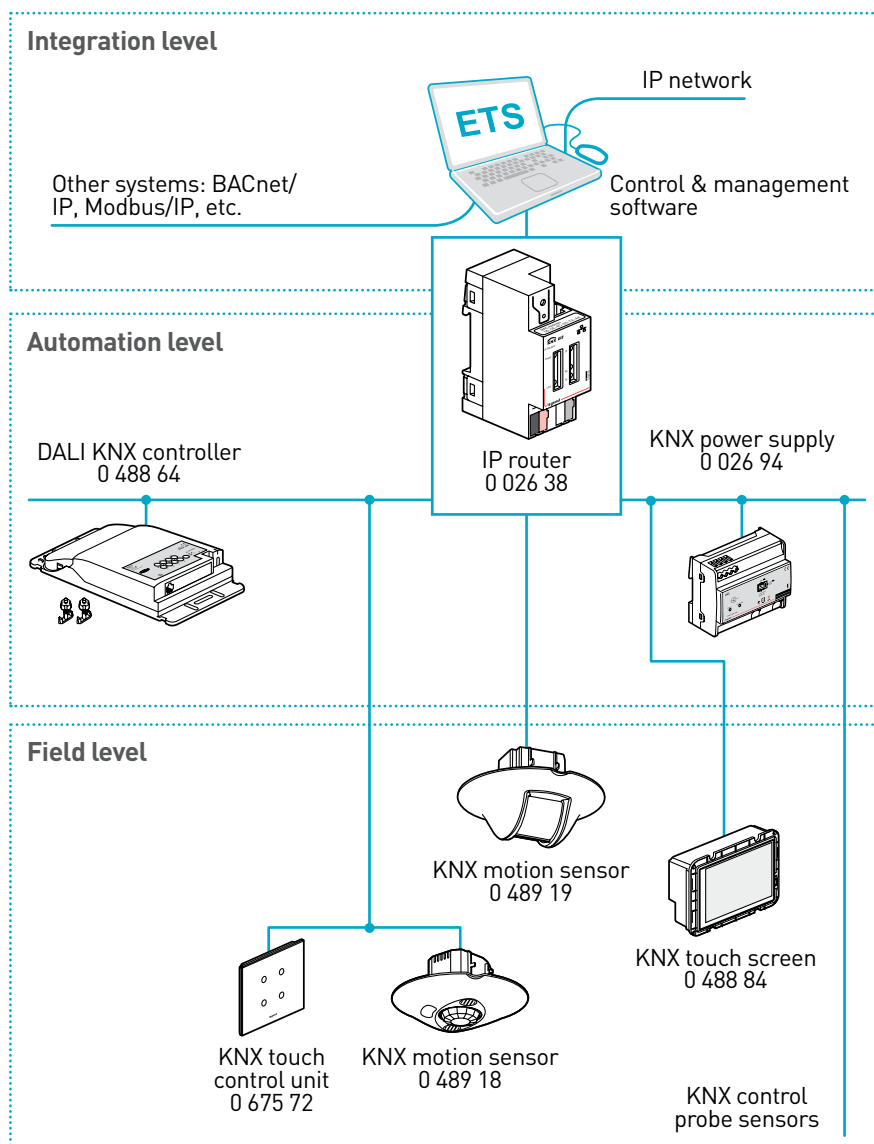

Topology

Operation of a KNX installation

A KNX installation comprises several participants which exchange data in the form of addresses. The basic topological element of a KNX installation is the line: the main line. Depending on the project, there may be several lines and several zones.

Topology - 1 Zone

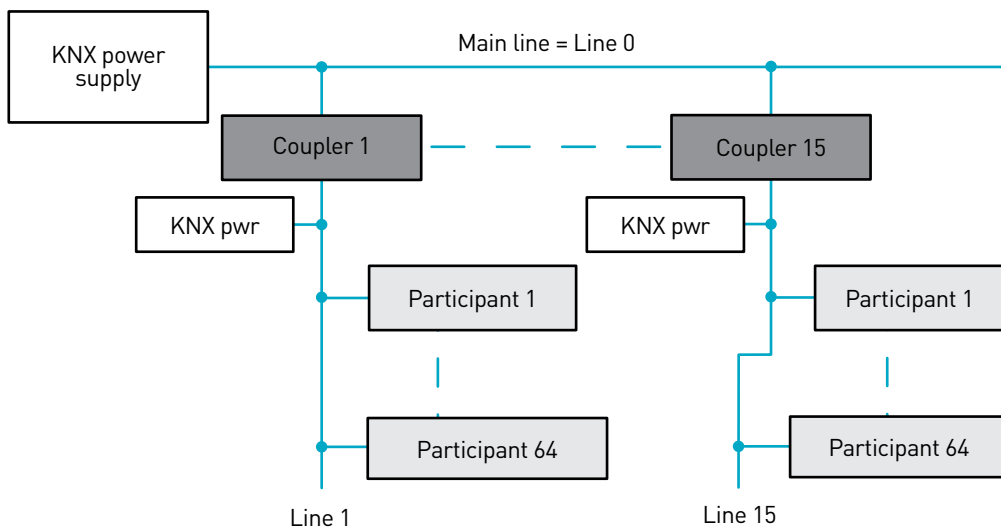

Topology - Several zones

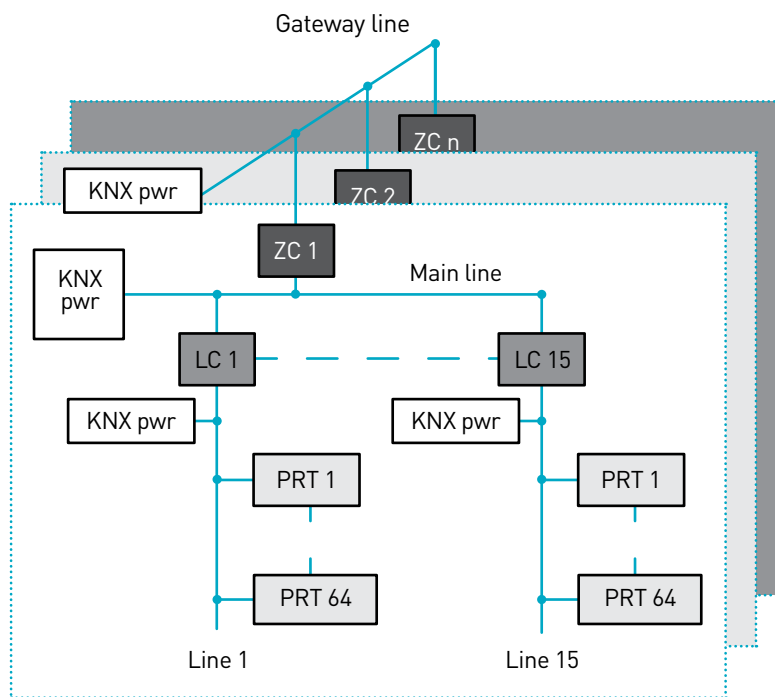

ZC = Zone coupler, LC = Line coupler, PRT = Participant

Presentation of the KNX offer (continued)

Topology (continued)

Physical address

Each participant is identified by a unique physical address designated by the zone number, the line number and the participant number on the line. The physical address is associated with the device by the user using ETS software.

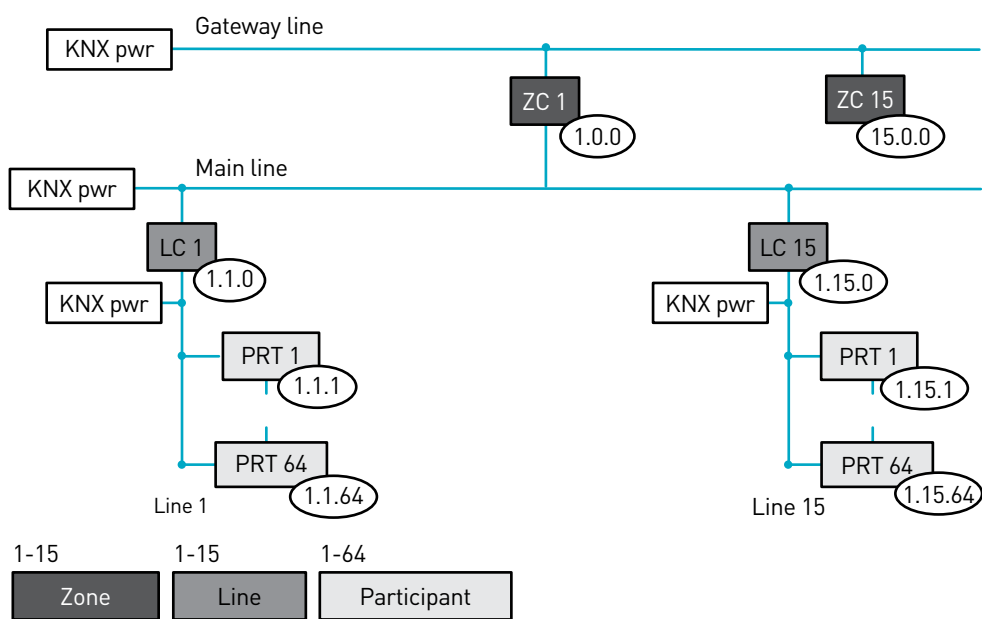

ZC = Zone coupler, LC = Line coupler, PRT = Participant

Group address

All KNX bus participants that are intended to function together, for example, a switch which controls the output(s) of an actuator, are assigned the same group address.

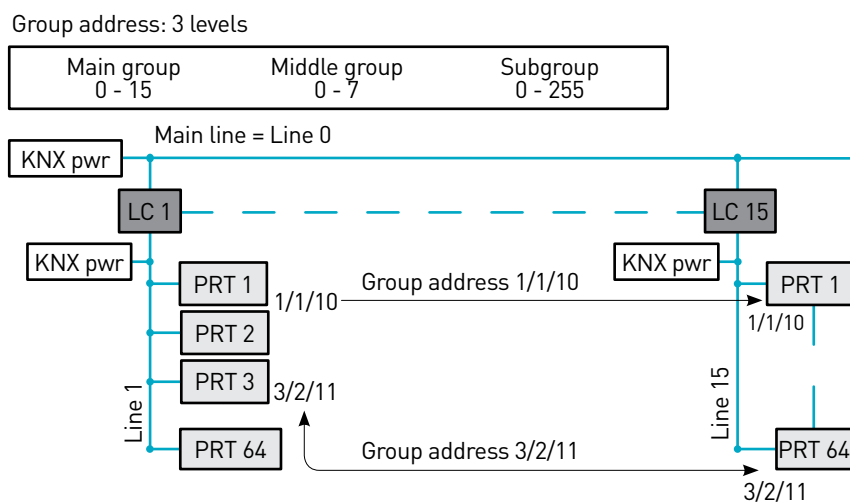

ZC = Zone coupler, LC = Line coupler, PRT = Participant

Topology (continued)

Wiring topologies

There are several wiring topologies. It is not necessary to have a terminating impedance.

Line



Star



Tree

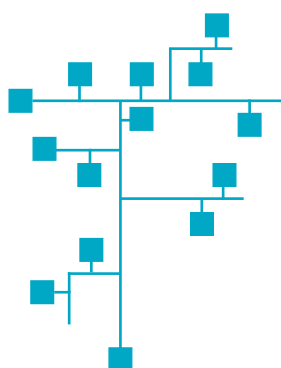

Wiring topology

The BUS must be supplied with 29 V_{DC}.

The data forming the KNX "message" is transmitted in differential serial mode at a rate of 9 600 bps.

A single pair (2 x 0.8 mm) or double pair (4 x 0.8 mm) cable must be used.

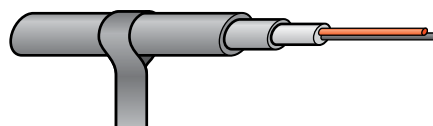

Maximum distances:

- Maximum BUS length: 1 000 m
- No need for terminating impedance
- Maximum distance between 2 devices: 700 m
- Maximum distance between a device and the KNX power supply: 350 m

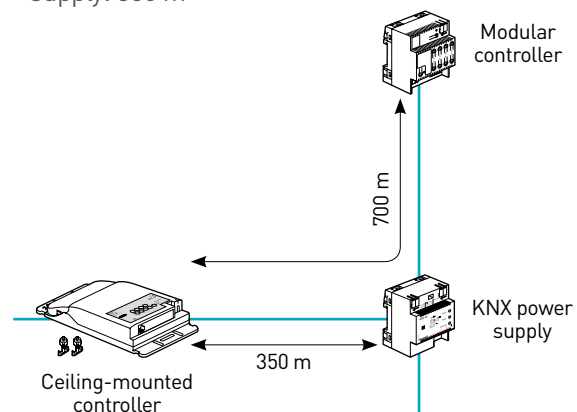

Device presentation and installation



0 784 89



5 735 02



0 675 72



0488 84

KNX control units

KNX control units are used to control lighting (ON/OFF, dimming, scenes, etc.), roller shutters and other receivers. They are equipped with 4 independent configurable channels and provide multiple lighting control functions.

Basic functions:

- ON/OFF switching
- +/- dimmer control
- Roller shutters: up, down, stop
- Scene: sending a scene number, saving a scene
- Sending one or two values: lighting level, shutter/louvre position, etc.

Advanced functions are also offered to customise the installation:

- Sending priority: ON/OFF locking and unlocking
- Sending an incremented command (in sequence): each press determines a command.

Example: 1st press = comfort mode (command 1)

2nd press = standby (command 2)

3rd press = eco mode (command 3)

4th press = comfort mode (command 1)

- Sending a dual action: sends 2 commands. This function is used to associate a scene with a device that does not have a scene function.

- Sending conditional Mode 1/Mode 2: Sends a command or a different second command depending on the condition. The control unit is capable of controlling different circuits depending on an event.

Each device is also equipped with 4 RGB LEDs which are fully-configurable using ETS to define colour and flashing mode.

A. Simple control units

1. Range

	Cat. No.	Description
	0 784 89	Mosaic control unit - 1 button, 1 actuation point
	0 784 95	Mosaic control unit - 1 button, 2 actuation points
	0 784 94	Mosaic control unit - 2 buttons, 2 actuation points
	0 784 96	Mosaic control unit - 2 buttons, 4 actuation points
	0 784 91	Mosaic control unit - 4 buttons, 4 actuation points
	0 675 71*	To be fitted with Céliane or Arteor cover plates Control unit with 1 or 2 buttons, 4 actuation points
	0 675 70	Céliane control unit - 4 buttons, 4 actuation points - white
	0 675 79	Céliane control unit - 4 buttons, 4 actuation points - titanium
	5 742 03*	Arteor control unit - 4 buttons, 4 actuation points, square - white
	5 744 04*	Arteor control unit - 4 buttons, 4 actuation points, square - magnesium
	5 735 02*	Arteor control unit - 4 buttons, 4 actuation points, round - white
	5 735 03*	Arteor control unit - 4 buttons, 4 actuation points, round - magnesium
	H4651KNX*	Axolute - 4-channel control unit without cover plate
	L4651KNX*	Livinglight - 4-channel control unit without cover plate
	HC4680KNX	Axolute - 4-channel control unit with label - tech
	HD4680KNX	Axolute - 4-channel control unit with label - white
	HS4680KNX	Axolute - 4-channel control unit with label - charcoal
	L4680KNX	Livinglight - 4-channel control unit with label - charcoal
	N4680KNX	Livinglight - 4-channel control unit with label - white
	NT4680KNX	Livinglight - 4-channel control unit with label - tech

* See Appendix p. 43 for choice of cover plates

Device presentation and installation continued



0 784 89



5 735 02



0 675 72

KNX control units continued

A. Simple control units continued

2. Technical characteristics

- Power supply: 29 V_{DC}
- KNX connector: red/black
- Terminal capacity: 4 x ($\emptyset 0.6 < \overset{8\text{mm}}{\square} < \emptyset 0.8$)
- Consumption: 7 mA max.
- Operating temperature: -5 °C to +45 °C
- Installation: - flush-mounted in 40 mm min. deep box
- surface-mounted in 2-module or 1-gang frame
- Dimensions (see data sheet)
- IP 40: Assembled product
- IP 20: Product without rocker plate
- IK 02

3. Communication objects

Type	Object
Inputs	1-bit Enable
Outputs	1-bit Switching
	4-bit Dimming
	1-byte Value status
	1-byte Counting
	1-byte Unsigned values
	1-bit Shutter Up/Down
	1-byte 8-bit scene
	2-bit Override

B. Touch control units

1. Range

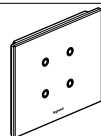
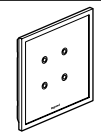
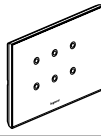
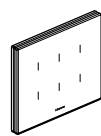
	Cat. No.	Description
	0 675 72	Céliane touch control unit - 4 actuation points china white glass
	0 675 74	Céliane touch control unit - 4 actuation points graphite grey glass
	5 735 04	Arteor touch control unit - 4 actuation points white
	5 735 05	Arteor touch control unit - 4 actuation points black
	5 735 12	Arteor touch control unit - 6 actuation points white
	5 735 13	Arteor touch control unit - 6 actuation points black
	HC4657M3KNX	Bticino touch control unit - 6 actuation points clear glass
	HD4657M3KNX	Bticino touch control unit - 6 actuation points white
	HS4657M3KNX	Bticino touch control unit - 6 actuation points black

2. Technical characteristics

- Power supply: 29 V_{DC}
- KNX connector: red/black
- Terminal capacity: 4 x ($\emptyset 0.6 < \overset{8\text{mm}}{\square} < \emptyset 0.8$)
- Consumption: 7 mA max.
- Operating temperature: -5 °C to +45 °C
- Installation: - flush-mounted in 40 mm min. deep box
- surface-mounted in 2-module or 1-gang frame
- Dimensions (see data sheet)
- IP 40: Assembled product
- IP 20: Product without rocker plate
- IK 04

3. Communication objects

Type	Object
Inputs	1-bit Enable
Outputs	1-bit Switching
	4-bit Dimming
	1-byte Value status
	1-byte Counting
	1-byte Unsigned values
	1-bit Shutter Up/Down
	1-byte 8-bit scene
	2-bit Override



0 488 84

KNX control units continued

C. Touch screen

1. Range

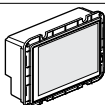
	Cat. No.	Description
	0 488 84	5.7" touch screen

The touch screen is used to set numerous KNX functions (from a range of approximately 110 standard functions) as well as to:

- Receive and display system data, such as the energy consumption profile chart, temperature, dimming level, etc.
- Control and manage a building using a single control unit

Configuration is carried out using the ETS tool.

Automation: timer programming, scenes, logic functions, presence simulation, chart display.

2. Technical characteristics

- Number of power supply terminal blocks: 1
- Terminal type: screw
- Terminal capacity: 2 x 1.5 mm² or 1 x 2.5 mm²
- Power supply via the KNX BUS: 29 V_{DC}
mains power: 230 V
- KNX input current: 4 mA
mains power: 230 V
- BUS line connector: KNX BUS connector
- Mini-USB connector: type B
- Power connector: 3 x 1.5 mm² with single-core or threaded conductor
- Operating temperature: -5 °C to +45 °C
- Storage temperature: -25 °C to +70 °C
- No-load power consumption: 4.4 W
- Weight: 420 g
- Location category: indoor use
- IP20 (installed in an enclosure)
- IK04

C. Touch screen continued

3. Communication objects

Type	Object
	3-byte Time adjustment
	3-byte Date adjustment
	1-bit Switch, ON/OFF
	4-bit Dimming, Brighter
	2-bit Forced control, ON/OFF
	1-bit Shutters, Up/Down
	1-byte Set value, Value
	2-byte Temperature, Value
	1-byte Set value, Counter
	1-byte Scene
	1-bit Heating mode, Comfort/standby/night
	1-byte Fan speed, Value
	1-bit Status, ON/OFF
	1-bit/1-byte/2-byte/4-byte Status display, Value
	1-byte Set value, Value
	1-bit Alarm/Event

Refer to the data sheet for more information.

Device presentation and installation continued



0 490 29



0 490 30



0 490 31



KNX thermostats

The KNX thermostat is used to take an ambient room temperature reading using an integrated sensor, an external ambient temperature sensor or an external return air temperature sensor, and to maintain the setpoint by sending commands to the actuator connected to the heating or air conditioning equipment.

HVAC applications:

- 2 ducts
- 2 ducts & electric heater
- 4 ducts
- 2 ducts, 3-position control

1. Range

	Cat. No.	Description
	0 490 29	Arteor KNX thermostat, white
	0 490 30	Arteor KNX thermostat, black
	0 490 31	KNX thermostat

2. Technical characteristics

- Power supply: 230 VAC
- Consumption: 5(2) A max.: Q1, Q2, Q3-N
5(2) A max.: Y11-N/Y21-N
6 A max.: Qx + Yxx
- Consumption on BUS/KNX: 20 mA
- Frequency: 50/60 Hz

3. Communication objects

Object
Fault information
Fault state (normal/faulty)
Fault transmission (enable/disable)
Room operating mode: Preset
Room operating mode: Time switch
Room operating mode: Status
Room operating mode: Window status
Room temperature
Room temperature
Room temp.: Comfort basic setpoint
Room temp.: Comfort setpoint
Room temp.: Current setpoint
Primary heating output
Primary cooling output
Application mode
Enable fan command value
Fan operation (0=Auto/11=Manual)
Fan command value
Fan output
Fan speed 1
Fan speed 2
Fan speed 3
X1: Temperature [°C]
X1: Digital [0/1]

Device presentation and installation continued



0 489 18



0 489 21



0 784 93

Ceiling-mounted or wall-mounted KNX detectors

KNX detectors are single or dual technology devices (with passive infrared (PIR) and/or ultrasonic (US) transmitter technology) capable of detecting human presence and measuring light levels.

Depending on the Cat.No., they can be ceiling-mounted, flush-mounted in a flush-mounting box, or surface-mounted.

They are ideal for use in the workplace, in offices, conference rooms and meeting rooms, for example.

Using the application program, it is possible to configure all the operating parameters, such as the light level threshold, time delay, operating modes and sensitivity. It is also possible to configure the following functions:

- Switching/dimming: automatically or manually if associated with a control device
- Definition of a minimum/maximum light level for dimming
- Correction of the dimming gradient
- Launch of scenes according to the light level and/or presence/absence of a person
- Operation in master/slave configuration
- Maintaining a constant light level in an unoccupied area until human presence is detected
- Option to control a second load with a different lighting level
- Signalling the end of detection by dimming the lighting
- Activation of auxiliary control unit when presence is detected (HVAC, etc.)

All the operating parameters can be configured using ETS. It is also possible to change the main operating parameters (light level threshold, time delay, sensitivity, etc.) using the configuration tool Cat. No. 0 882 30/BMS04001.



Parameter modifications made using the configuration tool Cat. No. 0 882 30/BMS04001 are not stored in ETS.

1. Range

	Cat. No.	Description
	0 489 18	Ceiling-mounted KNX 360° PIR/US detector IP20
	0 489 19	Ceiling-mounted KNX 2x180° PIR detector IP20
	0 489 20	Wall-mounted KNX 180° PIR/US detector IP42
	0 489 21	Wall-mounted KNX 270° + 180° PIR detector IP42
	0 489 22	High density ceiling-mounted KNX 360° PIR detector IP20
	0 675 77	Céliane - Flush-mounted KNX 180° PIR detector
	0 784 93	Mosaic - Flush-mounted KNX 180° PIR detector
	5 740 37	Arteur - Flush-mounted KNX 180° PIR detector - white
	5 740 79	Arteur - Flush-mounted KNX 180° PIR detector - magnesium
	L4658KNX	Livinglight - Flush-mounted KNX 180° PIR detector - charcoal
	N4658KNX	Livinglight - Flush-mounted KNX 180° PIR detector - white
	NT4658KNX	Livinglight - Flush-mounted KNX 180° PIR detector - tech

Device presentation and installation continued



0 489 18



0 489 21



0 784 93

Ceiling-mounted or wall-mounted KNX detectors continued

1. Range continued

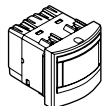
	Cat. No.	Description
	HC4658KNX	Axolute - Flush-mounted KNX 180° PIR detector - tech
	HD4658KNX	Axolute - Flush-mounted KNX 180° PIR detector - white
	HS4658KNX	Axolute - Flush-mounted KNX 180° PIR detector - charcoal

2. Technical characteristics

- Power supply: 29 V_{DC}
- KNX connector: red/black
- Terminal capacity: 4 x (∅ 0.6 <  < ∅ 0.8)
- Consumption on BUS/KNX: 7 mA max. (PIR)/
16 mA max. (PIR + US)
- Operating temperature: -5 °C to +45 °C
- Installation: - flush-mounted
- surface-mounted
- Dimensions (see data sheet)
- IP 40: Assembled product (0 675 77, 0 784 93, 5 740 37/79)
- IP 20: Product without rocker plate (0 675 77, 0 784 93, 5 740 37/79)
- IK 04

3. Communication objects

Type	Object
Inputs	1-bit Occupancy
	2-byte Setpoint
	2-byte Time delay
Outputs	1-bit Switching
	1-byte Level
	2-byte Lux
	1-byte Auxiliary output
	2-byte Setpoint
	2-byte Time delay
	1-bit Occupancy output
	1-bit Switching second light
	1-byte Level second light
	1-bit PB-Switching
4-bit PB-Switching	

Refer to the data sheet for more information.



0 784 61



0 883 09

Radio control units

0 784 61:

This batteryless radio control unit is used to control lighting (ON/OFF, dimming) and shutters (up, down, stop). It is used together with the radio/KNX interface Cat. No. 0 488 77. It is supplied complete with surround, support frame and cover plates.

0 488 77:

The KNX/Zigbee gateway Cat. No. 0 488 87 provides the interface with Zigbee devices such as the control units and sensors on the KNX bus. It can be mounted in a false ceiling and can control up to 16 KNX channels.

It is used for the following functions:

- Switching lights on/off
- Dimming
- Controlling roller shutters or blinds and slat angle
- Launching and saving different scenes
- Using 2 detectors (maximum) together

This interface is powered by the KNX bus.

0 883 09:

Wireless radio motion sensors are used to switch on lights connected to radio receivers when movement is detected. The lights stay on for a specific time delay. They feature 180° passive infrared detection. The recommended installation height is 2.5 m and the optimum distance between two sensors is 6 m.

1. Range

Radio control unit:

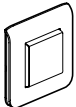
	Cat. No.	Description
	0 784 61	Batteryless radio control unit

Radio/KNX interface:

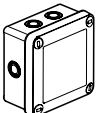
	Cat. No.	Description
	0 488 77	Radio/KNX interface

Motion sensors

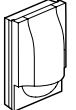
	Cat. No.	Description
	0 883 09	Wireless radio motion sensors

2. Technical characteristics

0 784 61:

- Power supply: Wireless and batteryless
- Consumption: 6 mA on primary line
8 mA on secondary line
- Network: radio, 2.4 GHz band (16 channels), IEE 802.15.4 (2003), data rate: 250 kbps
- Security: high and low (authentication by AES key, 128 bits)
- Operating temperature: +5 °C to +45 °C
- Humidity level: 95% max.
- Terminal capacity: 4 x (Ø 0.6 <  < Ø 0.8)
- Channel: all within 2.4 GHz band

0 488 77:

- Power supply: 29 V=
- Consumption on BUS/KNX: 12 mA
- Terminal capacity: 4 x (Ø 0.6 <  < Ø 0.8)
- 2.4 GHz frequency radio (16 channels), data rate: 250 Kbps. Wireless mesh network, self-adaptive and secure (AES 128), conforming to standard IEE 802.15.4 (LR-WPAN).
- Operating temperature: +5 °C to +45 °C
- Channel: all within 2.4 GHz band (11-26)

0 883 09:

- Power supply: 2 x AA alkaline batteries
- Consumption: 0.932 mA/2.796 W in operation
0.032 mA/0.096 W in standby
- Operating temperature: +5 °C to +45 °C
- PIR
- Detection range: 10 m
- Adjustable light level threshold: 0-1000 lux
- Adjustable time delay: 1 min-30 min
- IP 42
- IK 02
- Radio technology: 2.4 GHz
- Distance between 2 detectors: 150 m

3. Communication objects

Type	Object
Inputs	1-bit Enable
Outputs	1-bit Switching
	4-bit Dimming
	1-byte Value status
	1-byte Counting
	1-byte Unsigned values
	1-bit Shutter Up/Down
	1-byte 8-bit scene
	2-bit Override

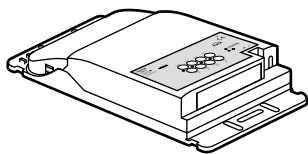

0 488 87

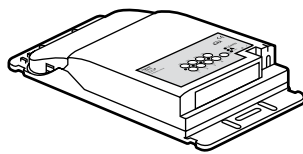

0 488 88

Controllers

A. Ceiling-mounted KNX controllers



Ceiling-mounted KNX controllers are actuators with 4 luminaire outputs.

They can be installed in cable trays or false ceilings.

They are used for the following functions:

- Switching lights on/off
- Dimming
- Lighting level
- Recalling and saving scenes
- Sending fault data

1. Range

	Cat. No.	Description
	0 488 87	Ceiling-mounted controller 1-10 V ballast - 4 outputs
	0 488 88	Ceiling-mounted controller DALI - 4 outputs

A. Ceiling-mounted KNX controllers continued

2. Technical characteristics

- Power supply: 29 V_{DC}
- KNX connector: red/black
- Terminal capacity: 4 x (Ø 0.6 <  < Ø 0.8)
- Consumption on BUS/KNX: 5 mA
- Operating temperature: -5 °C to +45 °C
- Installation: - in false ceiling
- in specially adapted cable tray
- Dimensions (see data sheet)
- IP 20
- IK 04

3. Communication objects

0 488 87:

Type	Object
Inputs	1-bit ON/OFF
	4-bit Dimming
	1-byte Level
	1-bit Enable/disable
	2-bit Force/unforce
	1-byte Scene
Outputs	1-bit ON/OFF status
	1-byte Value status

0 488 88:

Type	Object
Inputs	1-bit ON/OFF
	4-bit Dimming
	1-byte Level
	1-bit Enable/disable
	2-bit Force/unforce
	1-byte Scene
Outputs	1-bit ON/OFF status
	1-byte Value status
	1-bit DALI fault



0 484 22

Controllers continued

B. Multi-application modular controllers

Multi-application modular controllers are power modules equipped with output contacts for controlling:

- Any type of ON/OFF load (lighting, shutters, contactor, motor, etc.)
- A DALI dimming output (64 ballasts max.)
- An integrated energy meter

The loads are controlled using the associated control units (BUS/KNX or wired control units).

They are used for the following functions:

- ON/OFF or dimmer lighting control
- DALI control
- Roller shutter or ventilation control

1. Range

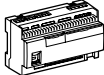
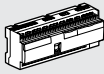
	Cat. No.	Description
	0 484 18	Controller with 8 inputs/10 outputs 8 modules
	0 484 22	Controller with 16 inputs/16 outputs 12 modules

0 484 18:

The multi-application modular KNX controller is specially designed for use in hotel rooms and meeting rooms. It comprises:

- 10 configurable binary outputs for controlling lighting (1 block of 4 relays: 4.3 A max.), shutters (2 blocks of 2 relays: 2.1 A max. across both blocks) and socket outlets (1 block of 2 relays: 16 A max.). Each output can be part of 5 scenes and 3 different modes. There are 2 separate integrated current measurements.
- 8 configurable auxiliary inputs for ON/OFF, dimmer, scene and shutter up/down/stop control via switches, push-buttons or other volt-free contacts.
- Functions for creating scenes and advanced logic: 3 “logic blocks” for sending a command according to 3 conditions and 3 other “programming blocks” for sending 5 different actions in 1 command.

B. Multi-application modular controllers continued

0 484 22:

The multi-application modular KNX controller is specially designed for use in hotel rooms and meeting rooms. It comprises:

- 16 configurable binary outputs for controlling lighting (2 blocks of 4 relays: 4.3 A max. across both blocks), shutters (2 blocks of 2 relays: 2.1 A max. across both blocks) and socket outlets (2 blocks of 2 relays: 16 A max. across both blocks). Each output can be part of 5 scenes and 3 different modes. There are 4 separate integrated current measurements.
- 16 configurable auxiliary inputs for ON/OFF, dimmer, scene and shutter up/down/stop control via switches, push-buttons or other dry contacts.
- Functions for creating scenes and advanced logic: 3 “logic blocks” for sending a command according to 3 conditions and 3 other “programming blocks” for sending 5 different actions in 1 command.

2. Technical characteristics

0 484 18:

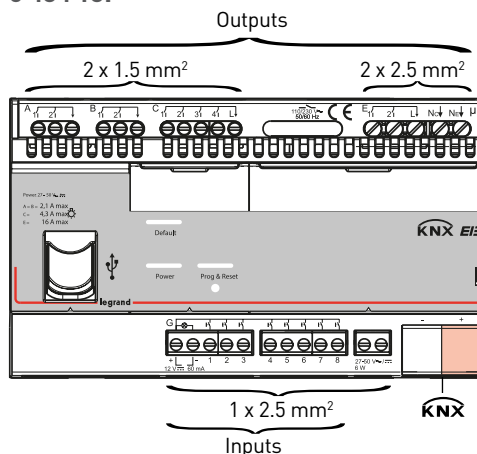

- Power supply: 27-50 V~/± 6 W
- Consumption on BUS/KNX: 5 mA
- Terminal type: screw
- KNX connection: 0.6 to 0.8 mm²
- Location category: indoor use
- Operating temperature: -5 °C to + 45 °C
- IP 20
- IK 04



0 484 22

Controllers continued

B. Multi-application modular controllers continued

2. Technical characteristics continued

0 484 22:

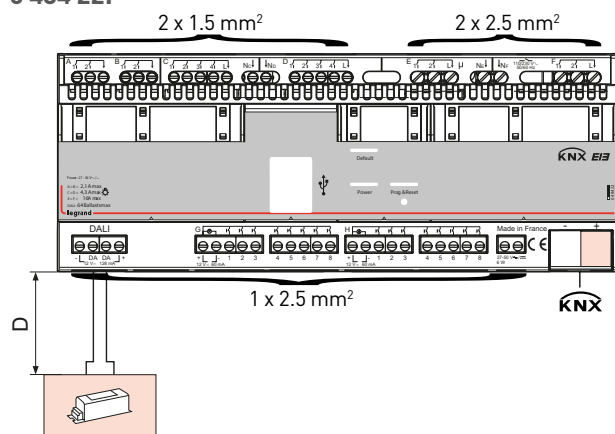

DALI	∅
≤ 100 m	0.5 mm ²
≤ 150 m	0.75 mm ²
≤ 300 m	1.5 mm ²

- Power supply Cat. No. E49: 27-50 V~/= 6 W
- Consumption on BUS/KNX: 5 mA
- Terminal type: screw
- KNX connection: 0.6 to 0.8 mm²
- Location category: indoor use
- Operating temperature: -5 °C to + 45 °C
- IP 20
- IK 04

B. Multi-application modular controllers continued

3. Communication objects

0 484 18:

Type	Object
Inputs	1-bit Switch
	1-bit Shutters
	8-bit Scene control
	1-bit Mode control [1, 2 and 3]
	2-bit Priority (forcing)
	8-bit Incrementation (counting)
	4-bit Dimming
	1 x 1-byte Unsigned value
	2 x 1-byte Unsigned value
	Outputs
1-bit Exclusive (DND/MakeUpRoom function)	
1-bit ON/OFF	
4-byte Energy and Power Meter	
1-bit/2-bit/4-bit/1-byte/2-byte/4-byte Program functions	
1-bit/2-bit/4-bit/1-byte/2-byte/4-byte Logic functions (AND, OR, NAND, NOR, XOR)	

0 484 22:

Type	Object
Inputs	1-bit Switch
	1-bit Shutters
	8-bit Scene control
	1-bit Mode control [1, 2 and 3]
	2-bit Priority (forcing)
	8-bit Incrementation (counting)
	4-bit Dimming
	1 x 1-byte Unsigned value
	2 x 1-byte Unsigned value
	Outputs
1-bit Exclusive (DND/MakeUpRoom function)	
1-bit ON/OFF	
1-bit DALI switch	
1-byte DALI level	
2-bit DALI override	
4-bit DALI dimming	
4-byte Energy and Power Meter	
1-bit/2-bit/4-bit/1-byte/2-byte/4-byte Program functions	
1-bit/2-bit/4-bit/1-byte/2-byte/4-byte Logic functions (AND, OR, NAND, NOR, XOR)	



0 026 61

Controllers continued

C. ON/OFF controllers 0026 61/62

KNX controllers Cat. Nos 0026 61/62 are modular devices equipped with 4 and 8 outputs respectively. They are capable of controlling 4 and 8 different groups of electrical loads independently.

The main functions are as follows:

- Instantaneous ON/OFF switching
- Delayed ON/OFF switching
- Timed ON
- Operating mode selection (time switch mode or normal mode)
- Definition of an ON period during night mode
- Configuration of switching status after mains power restored
- Assignment of scenes to outputs (each output can be part of a maximum of 8 scenes)
- Configuration of logic AND/OR operations on each output
- Configuration of a "warning" before switching over to night mode or time switch mode

These controllers are equipped with an internal 230 VAC power supply. It is possible to control the load manually in the event of a KNX bus failure using the push-buttons on the front of the controller.

1. Range

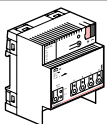
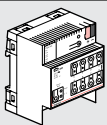
	Cat. No.	Description
	0 026 61	Controller with 4 outputs 4 modules
	0 026 62	Controller with 8 outputs 4 modules

C. ON/OFF controllers 0026 61/62 continued

2. Technical characteristics

- Power supply: 29 V_{DC}
- KNX connector: red/black
- Terminal capacity: 4 x (Ø 0.6 < $\frac{8 \text{ mm}}$ < Ø 0.8)
- Operating temperature: -5 °C to +45 °C
- IP 20
- IK 04
- Integrated 230 V~ power supply, +10%/-15%
- Consumption on BUS/KNX: 5 mA
- Power consumption: 1.1 W max.
- Dimensions (see data sheet)

3. Communication objects

Type	Object
Inputs	8-bit Scene control
Outputs	1-bit Timed ON/OFF
	1-bit Logic functions (AND, OR)



0 026 80

Controllers continued

D. ON/OFF controllers 0026 80/81/82

The modular ON/OFF KNX controller Cat. No. 0026 80 is used to control 4 independent outputs with a maximum current of 16 A.

The main functions are as follows:

- Switching
- Time-delayed switching (on delay and/or off delay)
- Timer with cut-off warning
- Logic operations AND, OR, etc. on the outputs
- Option to program 5 scenes
- Switching threshold by configurable input
- Programming of contact behaviour on loss or return of BUS/KNX

This controller is powered by the KNX bus and therefore does not need any other power supply.

1. Range

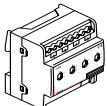
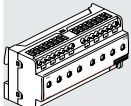
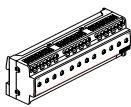
	Cat. No.	Description
	0 026 80	ON/OFF KNX controller 4 x 16 A outputs 4 modules
	0 026 81	ON/OFF KNX controller 8 x 16 A outputs 8 modules
	0 026 82	ON/OFF KNX controller 12 x 16 A outputs 12 modules

2. Technical characteristics

- Power supply: 29 V_{DC}
- KNX connector: red/black
- Terminal capacity: 4 x (Ø 0.6 <  < Ø 0.8)
- Operating temperature: -5 °C to +45 °C
- IP 20
- IK 04
- Integrated 230 V~ power supply
- Consumption on BUS/KNX: 12 mA
- Dimensions (see data sheet)

D. ON/OFF controllers 0026 80/81/82 continued

3. Communication objects

Type	Object
	1-bit Timer
	1-bit Preset call/store
	1-bit Logic 2 input
	8-bit Scene control
	1-byte Threshold
	1-bit Forced
	1-byte ON/OFF
	1-bit PWM



0 026 59



0 026 86



0 026 88

Controllers continued

E. Modular dimming controllers

002635:

The modular DALI (digital addressable lighting interface) controller combines the cross-functional KNX installation bus and the DALI bus specifically designed for lighting control. It is thus possible to integrate luminaires equipped with cost-effective digital DALI ballasts in a global KNX architecture and control them from a number of existing KNX devices.

The modular DALI controller acts as both DALI master interface and power supply for up to 64 connected ballasts.

The ballasts can be switched, attenuated or set to a defined value in a maximum of 16 groups per gateway. The actual light value or the error status of each group (error status of ballasts/luminaires in each group) can be exported, for example, to a display interface via a KNX gateway.

The modular DALI controller can be used not only to control the group, but also to control up to 64 ballasts. In the latter case, there is one object per ballast. A parameter determines whether each ballast should be switched, attenuated or set to a defined value.

An error status object is available for each ballast. This allows luminaires and ballasts with an anomaly to be located precisely. Three objects can be used for total control of all the ballasts connected via Broadcast (no DALI commissioning is needed in this case).

In addition, each group can be used to program and load up to 16 lighting scenes. Scenes are controlled by a 1-byte object.

The modular DALI controller can be used to commission the DALI (assignment of DALI ballasts to the various groups and modification of the configuration) in two different ways.

E. Modular dimming controllers continued

002663:

The modular KNX/DALI controller Cat. No. 0026 63 is used to control 8 DALI outputs (channels) each of which can be connected to a group comprising a maximum of 8 DALI ballasts.

The DALI protocol can be used not only for switching and dimming in lighting control but also to receive status, failure and error data from the ballasts.

The main functions are as follows:

- Switching, dimming and sending a dimming value
- Mode selection: Normal, Mode 1 or Mode 2 (timed dimming levels)
- Configuration of ON/OFF switching, 0-100% and 100%-0% of the dimming time
- Configuration of a minimum/maximum dimmer level
- Configuration of the same parameters for all channels or different settings for each channel
- Configuration of the Switching ON value by changing the dimming value
- Configuration of behaviour on loss of current
- Configuration of an 8-bit scene for each channel, with the option to assign a channel to a maximum of 16 scenes
- Configuration of switching/dimming/lamp failure and DALI status feedback

This controller is equipped with an internal 230 VAC power supply. It is possible to control the load manually in the event of a KNX BUS failure using the push-buttons on the front of the controller.



0 026 59



0 026 86



0 026 88

Controllers continued

E. Modular dimming controllers continued

002686:

This universal KNX dimmer Cat. No. 002686 is used for dimmer control on 4 outputs with a maximum power of 500 W.

It is compatible with incandescent and halogen lamps with ferromagnetic or electronic transformers.

It features an integrated automatic learning phase for the associated loads (R, L or C type loads).

The main functions are as follows:

- Configuration of normal/timer operating mode
- Behaviour on reception of switch on command and/or configurable dimming command
- Predefined configurable dimming values
- Up to 15 configurable scenes

This controller is powered by the KNX bus and therefore does not need any other power supply.

002687:

This universal KNX dimmer Cat. No. 002686 is used for dimmer control on 2 outputs with a maximum power of 500 W.

It is compatible with incandescent and halogen lamps with ferromagnetic or electronic transformers.

It features an integrated automatic learning phase for the associated loads (R, L or C type loads).

The main functions are as follows:

- Configuration of normal/timer operating mode
- Behaviour on reception of switch on command and/or configurable dimming command
- Predefined configurable dimming values
- Up to 15 configurable scenes

This controller is powered by the KNX bus and therefore does not need any other power supply.

E. Modular dimming controllers continued

002688:

This 1-10V KNX dimmer Cat. No. 002688 is used for dimmer control on 4 x 1-10V ballast circuits with a maximum of 100 mA per circuit. It is also equipped with 4 contacts for electrically breaking the 4 circuits.

The main functions are as follows:

- Switching/dimming
- Configuration of normal/timer operating mode
- Up to 15 configurable scenes
- Behaviour on reception of switch on command and/or configurable dimming command
- Predefined configurable dimming values

002659:

The DIN KNX controller Cat. No. 002659 is used to control dimming on 2 circuits. If used together with Cat. No. 002660, it can control up to 6 circuits.

It can be used with incandescent lamps, low and high voltage halogen lamps and dimmable LEDs. The dimmer power is 400 W per channel.

This increases to 800 W if 2 channels are installed in parallel.

Identification of the associated loads is automatic (R, L or C load types).

This controller can also be used for fan control.

To check that the wiring is correct, each channel can be controlled locally on the controller by means of the push-buttons and LEDs on the front panel.

KNX programming can be used for ON/OFF switching, manual dimming or automatic dimming via a sensor and scene control among numerous other functions. The tilt angle can be modified.

A minimum/maximum dimming threshold can also be defined to ensure consistent dimming.

002660:

The DIN KNX controller Cat. No. 002660 is an extension that adds 2 additional channels to Cat. No. 002659.



0 026 59



0 026 86



0 026 88

Controllers continued

E. Modular dimming controllers continued

1. Range

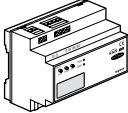
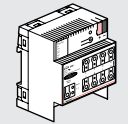
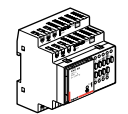
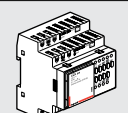
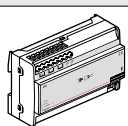
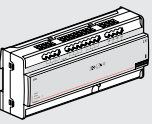
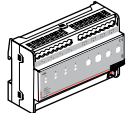
	Cat. No.	Description
	0 026 35	BUS/KNX - DALI controller 6 modules
	0 026 63	DALI controller with 8 outputs 4 modules
	0 026 59	Universal dimmer 4 modules
	0 026 60	Extension for Cat. No. 0 026 59 4 modules
	0 026 86	KNX dimmer 2 x 500 W 8 modules
	0 026 87	KNX dimmer 4 x 400 W 12 modules
	0 026 88	KNX dimmer 1-10 V 8 modules

2. Technical characteristics

0 026 35:

- Power supply: 110-240V~
- Power supply: 29 V=, wired on KNX BUS
- Power consumption: 0.1 A max.
- 16 regulation groups
- 16 scenes
- 64 ballasts per group
- Fault management
- Operating temperature: -5 °C to +45 °C
- IP 20

E. Modular dimming controllers continued

2. Technical characteristics continued

0 026 63:

- Power supply: 230V~
- Power supply: 29 V=, wired on KNX BUS
- Power consumption: 6 W max.
- Consumption on BUS: 11 mA
- KNX connector: red/black
- KNX terminal capacity: 4 x ($\varnothing 0.6 < \overset{8\text{mm}}{\text{mm}} < \varnothing 0.8$)
- Operating temperature: -5 °C to +45 °C
- IP 20

0 026 59:

- Power supply: 230V~
- Power supply: 29 V=, wired on KNX BUS
- Power consumption: 0.9 W (in standby)
- Consumption on BUS: 10 mA
- Operating temperature: -5 °C to +45 °C
- IP 20

0 026 86/87:

- Power supply: 230V~
- Power supply: 29 V=, wired on KNX BUS
- Frequency: 50 Hz
- Operating temperature: -5 °C to +45 °C
- IP 20

0 026 88:

- Power supply: 29 V=, wired on KNX BUS
- Operating temperature: -5 °C to +45 °C
- IP 20

3. Communication objects

0 026 35:

Type	Object
Inputs	1-bit ON/OFF
	4-bit Dimming
	1-byte Level
	1-bit Enable/disable regulation
	1 clock
	1-byte Scene
Outputs	1-bit ON/OFF status
	1-byte Value status
	1-bit Lamp fault
	1-bit Ballast fault
	1-bit DALI BUS fault



0 026 86



0 026 88



0 026 91

Controllers continued

E. Modular dimming controllers continued

3. Communication objects continued

0 026 59/60:

Object
1-bit Switching, ON/OFF
4-bit Brighter/darker
1-byte Dimming value
1-bit Soft switching
1-bit Lock
1-byte Call up/save scenes
1-bit Lock scenes = 1
1-bit Force = 1
1-byte Dimming value
1-bit Feedback, ON/OFF
1-byte Feedback in %
2-byte Operating hours feedback
1-bit Reset operating hours
1-bit General error message
1-bit Short circuit message
1-bit Excess temperature message
1-bit Mains power failure
1-bit Load type message (R, C/L)

0 026 63:

Object
1-bit Direct mode status, ON/OFF
1-byte 8-bit scene recall/program
1-bit Night mode, ON/OFF
1-bit Switching, ON/OFF
4-bit Dimming, Brighter/Darker
1-byte Dimming value
1-bit Switching status, ON/OFF
1-byte Dimming value status
1-bit Lamp failure status
1-byte DALI status

0 026 86/87/ 88:

Object
1-bit Switch
1-bit Switch status
4-bit Relative dimming
1-byte Brightness
1-byte Brightness status
1-byte Scene/save scenes
1-bit Preset

F. Roller shutter controller

This modular KNX controller with 4 outputs is used to control roller shutters, awnings or Venetian blinds.

The main functions are as follows:

- Control of roller shutters, awnings or Venetian blinds.
- Configurable up/down time and slat angle
- 5 configurable scenes (max.)
- Shutter position stored in memory
- Scene control for wind/frost/rain

This controller is powered by the KNX bus and therefore does not need any other power supply.

1. Range

Cat. No.	Description
0 026 91	Controller with 4 outputs 4 modules

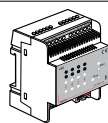

2. Technical characteristics

- Power supply: 29 V_{DC}
- KNX connector: red/black
- Terminal capacity: 4 x (Ø 0.6 < $\frac{8\text{mm}}$ < Ø 0.8)
- Operating temperature: -5 °C to +45 °C
- Dimensions (see data sheet)
- IP 20 (installed in an enclosure)
- IK 04

3. Communication objects

Object
1-bit Shutter/Venetian blind
1-byte Shutter/blind/slats position
1-byte Shutter/Venetian blind status



0 026 93



0 026 92

BUS/KNX interface input modules

0 026 55:

The KNX input module Cat. No. 0 026 55 is a modular rail-mounted device with 8 inputs (volt-free contacts) used to perform the following functions:

- Logging of switching status (open/closed) and changes of state (open/close) of the various contacts. Check of the contact switching status and operating status (device connection status, alarms, etc.)
- Logging of the switching contacts and count of the number of switching operations (with a minimum interval of 70 ms between contact activations and a maximum number of 5 pulses per second) and comparison with reference thresholds. The LED on the front panel indicates the status of each input.

0 026 92:

The universal KNX interface Cat. No. 0 026 92 comprises 4 I/O used to connect peripheral input devices (such as switches or push-buttons) or LEDs to the KNX BUS.

It is used for the following functions:

- ON/OFF or dimming control
- Control of roller shutters or blinds
- Sending values (temperature, time, etc.)
- Sending and saving scenes
- Creating an illuminated indicator
- Control of different loads via multiple presses of push-button
- Control of different loads via switching sequence
- Standard and differential counting

This interface is powered by the KNX bus.

0 026 93:

The binary KNX interface Cat. No. 0 026 93 is a modular unit with 4 binary contact inputs. These inputs are used as the interface between the standard push-buttons or switches and the KNX system, or for signal coupling (24 V to 230 V~ input voltage).

The interface is used for the following functions:

- ON/OFF or dimming control
- Control of roller shutters or blinds
- Sending values (temperature, time, etc.)
- Sending and saving scenes
- Control of different loads via multiple presses of push-button
- Control of different loads via switching sequence
- Standard and differential counting

A red LED indicates the status of each input contact (LED off = contact open; LED on = contact closed).

This interface is powered by the KNX bus.

1. Range

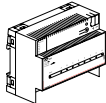
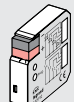
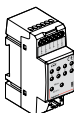
	Cat. No.	Description
	0 026 55	Modular BUS/KNX interface 6 modules
	0 026 92	KNX interface with 4 inputs/4 outputs 1 module
	0 026 93	KNX interface with 4 x 230 V inputs 2 modules

2. Technical characteristics

0 026 92/93:

- Power supply: 29 V~
- Terminal capacity: 4 x ($\varnothing 0.6 < \text{8 mm} < \varnothing 0.8$)
- Operating temperature: -5 °C to +45 °C

0 026 55:

- Power supply: 230 V~
- Frequency: 50/60 Hz



0 026 93



0 026 92

BUS/KNX interface input modules continued

3. Communication objects

0 026 92:

Type	Object
	1-bit Switching
	4-bit Dimming
	1-byte 2 Values (0...255) short/long operation
	5 x 1-bit/5 x 1-byte Scene control
	1-bit Shutter
	5 levels 1-bit Switching sequence
	8-bit/16-bit/32-bit Counter
	1-bit Multiple operation

0 026 55:

Type	Object
	Status transmission
	Switching between rising edge/falling edge
	Switching between short press/long press
	Dimmer control unit with 1 input
	Roller blind control unit with 1 input
	Multi-action control unit, sends up to 3 on/off commands
	1-bit scene control
	8-bit scene control
	Send 8-bit value on rising edge/falling edge
	Send 8-bit value on short press/long press
	Send 16-bit floating value on rising edge/falling edge
	Send 16-bit floating value on short press/long press
	Send 8-bit incremented commands without threshold monitoring
	Send 8-bit incremented commands with threshold monitoring
	Send 16-bit incremented commands without threshold monitoring
	Send 16-bit incremented commands with threshold monitoring
	Send 32-bit incremented commands without threshold monitoring
	Send 32-bit incremented commands with threshold monitoring

3. Communication objects continued

0 026 93:

Type	Object
	1-bit Switching
	4-bit Dimming
	1-byte Value/forced output
	1-bit/1-byte value/2-byte value Scene control
	1-bit Switching sequence
	2-byte Counter
	1-bit Multiple operation
	1-bit Shutter control

Device presentation and installation continued



0 026 94



0 035 12

Infrastructure devices

A. USB interface

The BUS/KNX - USB interface is a DIN rail-mounted device. It is used to connect a PC to the BUS/KNX in order to address, configure, display, connect and perform diagnostics on BUS devices via the USB port.

1. Range

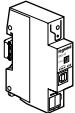
	Cat. No.	Description
	0 035 47	USB interface 1 module

2. Technical characteristics

- KNX connector: red/black
- Terminal type: automatic
- Terminal capacity: 4 x ($\varnothing 0.6 < \begin{matrix} \text{---} \\ \text{8 mm} \\ \text{---} \end{matrix} < \varnothing 0.8$)
- USB connection: USB type B
(max. cable length 5 m, cable not included)
- Transmission speed: 9 600 bps between the interface and the BUS; 12 Mbps between the USB 1.1 interface and the PC
- Operating temperature: -5 °C to +45 °C
- IP 20
- IK 04

3. Operating principle

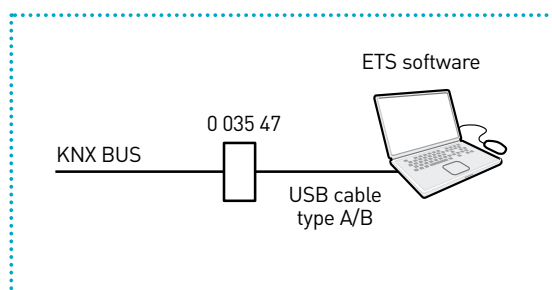

B. KNX power supplies

0 026 94, 0 035 12:

The modular KNX power supply provides the voltage required to power the KNX bus. Connection to the KNX BUS is via the red/black terminal on the front of the unit. The built-in filter prevents short-circuiting of telegrams on the KNX bus line.

The power supply Cat. No. 0 026 94 is also capable of providing a 24 VDC supply from the yellow/white auxiliary terminal which can be used to power another SELV line using a decoupling filter (to be purchased separately).

1. Range

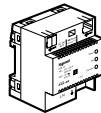
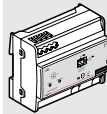
	Cat. No.	Description
	0 035 12	320 mA - 4M 4 modules
	0 026 94	640 mA - 6M 6 modules

2. Technical characteristics

- Power supply: 120-230 V~
- Frequency: 50/60 Hz
- Output voltage: 29 V \approx
- Output current Cat. No. 0 026 94: 640 mA
- Output current Cat. No. 0 035 12: 320 mA
- KNX connector: red/black
- Terminal capacity: 4 x ($\varnothing 0.6 < \begin{matrix} \text{---} \\ \text{8 mm} \\ \text{---} \end{matrix} < \varnothing 0.8$)
- Terminal type: automatic
- Operating temperature: -5 °C to +45 °C
- IP 20
- IK 04



0 035 16



0 035 43

Infrastructure devices continued

C. Line coupler

This device provides the data link between two separate BUS/KNX lines and isolates the BUS lines from one another to allow independent local operation on a single BUS line.

The line coupler can be used as a:

- Line coupler
- Zone coupler
- Repeater on either existing BUS networks or new BUS/KNX networks. It has a filtering function that can be used to either block telegrams from the BUS on one of the two lines, or transmit them to another BUS line, thus reducing the load on the BUS.

1. Range

	Cat. No.	Description
	0 035 16	Line coupler 2 modules

2. Technical characteristics

- Power supply: 29 V_{DC}
- KNX connector: red/black
- Terminal capacity: 4 x (Ø 0.6 < $\frac{8\text{mm}}$ < Ø 0.8)
- Consumption: 6 mA on primary line
8 mA on secondary line
- Operating temperature: -5 °C to +45 °C
- IP 20
- IK 04

3. Operating principle

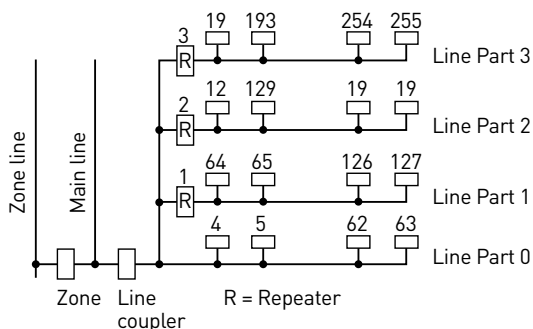

D. IP communication module

0 035 43:

The KNX/IP gateway has an embedded Web server for launching scenes remotely. This means that it can be used on any PC, tablet or smartphone with a web browser. It also features an IP connection to the KNX bus as well as an object server that can be used in parallel.

It is used for the following functions:

- Access to a maximum of 40 functions via the embedded Web server
- Commissioning, configuration and diagnostics of KNX installations over Ethernet using ETS
- Establishing a connection to KNX/IP-based software

0 026 38:

The IP/KNX router is a network coupler for interconnecting 2 KNX networks via the IP infrastructure. This device also provides the advantage of simultaneous access to the BUS line from a PC, tablet or smartphone. The router can be accessed locally via the LAN or remotely. It requires a dedicated power source which can be PoE (Power over Ethernet) or an unfiltered 29 VDC BUS power supply.

The IP router characteristics are as follows:

- Simultaneous connection of 4 clients
- Direct access to the KNX installation from any access point on the IP network (KNXnet/IP)
- Rapid communication between KNX lines, zones and systems (KNXnet/IP)
- Inter-building and inter-site communication
- Telegrams filtered and routed by:
 - Individual address
 - Group address
- LED display for:
 - operation
 - KNX communication
 - IP communication
- Simple configuration using ETS version 3 or later
- Easy connection to monitoring systems



0 035 43

Input module continued

D. IP communication module continued

1. Range

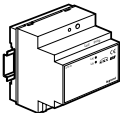
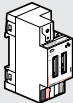
	Cat. No.	Description
	0 035 43	IP communication module 4 modules
	0 026 38	IP/KNX router 2 modules

2. Technical characteristics

0 035 43, 0 026 38:

- Bus voltage: via the KNX BUS
- Operating voltage: provided by a safety extra low voltage (SELV) power supply, nominal voltage of 27 V \approx range of permissible input voltages 24 to 29 V \approx
- Power supply: 27 V \approx
- Connections:
 - KNX BUS line: screwless bus connection block (red/black), \varnothing 0.6 to 0.8 mm single-core wire stripped back approximately 5 mm
 - Ethernet/IP network: RJ45 connector
 - Auxiliary power supply: screwless ELV voltage terminal (yellow/white), \varnothing 0.6 to 0.8 mm single-core wire stripped back approximately 8 mm
- Mounted on DIN rail
- Operating temperature: 0 °C to +45 °C
- IP 20
- IK 04

0 026 38:

- Auxiliary power supply:
- PoE (Power over Ethernet) 48 V= max. 0.8 W
- Ethernet: 10BaseT (10 Mbps)

D. IP communication module continued

3. Communication objects

0 035 43:

Type	Object
	1-bit Switch command
	1-bit Feedback
	1-bit Presence
	4-bit Dimming
	1-bit Blind
	1-bit Shutter
	1-byte Relative value (0 to 1130%)
	1-byte Value (0 to 255)
	2-byte Floating point
	4-byte Floating point
	2-byte Counter
	4-byte Counter
	1bit Scene call/program
	1-bit Scene program
	1byte Scene call/program

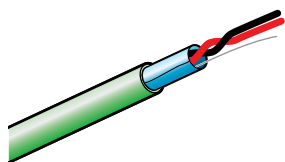

0 492 91

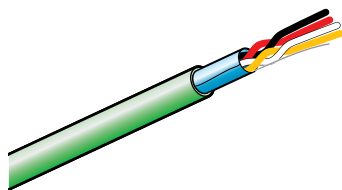

0 492 92



0 488 79

Input module continued

E. KNX cables

KNX cables are available in single pair or double pair versions.

They are supplied in 500 m lengths.

Colour RAL 6018 green.

1. Range

	Cat. No.	Description
	0 492 91	Single pair KNX cable
	0 492 92	Double pair KNX cable

2. Technical characteristics

- Copper cable - Bare 0.5 mm² - Ø 0.80 mm
- Maximum DC resistance loop: 73.2 Ohm/km
- Maximum capacitance at 800 Hz: 100 nF/km
- Inductance: 0.65 mH/km
- Maximum DC operating voltage: 800 V
- Maximum AC operating voltage (5 min): 2500 V
- Maximum AC operating voltage (1 min): 4500 V
- Insulation: PE - Ø 1.6 mm
- Insulation resistance (at 500 V, 1 min): 10 GOhm km
- Number of pairs: 1 pair (2 conductors/pair)
- Conductor identification: RED/BLACK
- Packaging: 1 x PET sheet
- Within the shielding: wire aluminium foil-film + 0.4 mm² copper drain wire
- Ripcord and identification thread: Yes
- External diameter: 5.5 mm²
- Smoke density: IEC 61034-2
- Corrosive gases in event of fire: IEC 60754-1/2
- Outer sheath: LSFROH - green RAL 6018
- Cable marking: LEGRAND EIB BUS LSFROH 1x2/0.8, week, year, batch number and marking counter
- Operating temperature: -25 to +70 °C

F. Accessories and connector

The KNX red and black connector Cat. No. 0 488 79 is used to connect cables (connection and/or tap-off). (This connector is included with Legrand products).

Introduction

When creating a KNX project, it is essential to follow a sequence in terms of both the method and the actions to be carried out. Legrand's Pro Relations service offers the expertise and services needed to support you through your project.

The diagram below shows the actions required and the method to be adopted for each of these actions is described on the following pages.

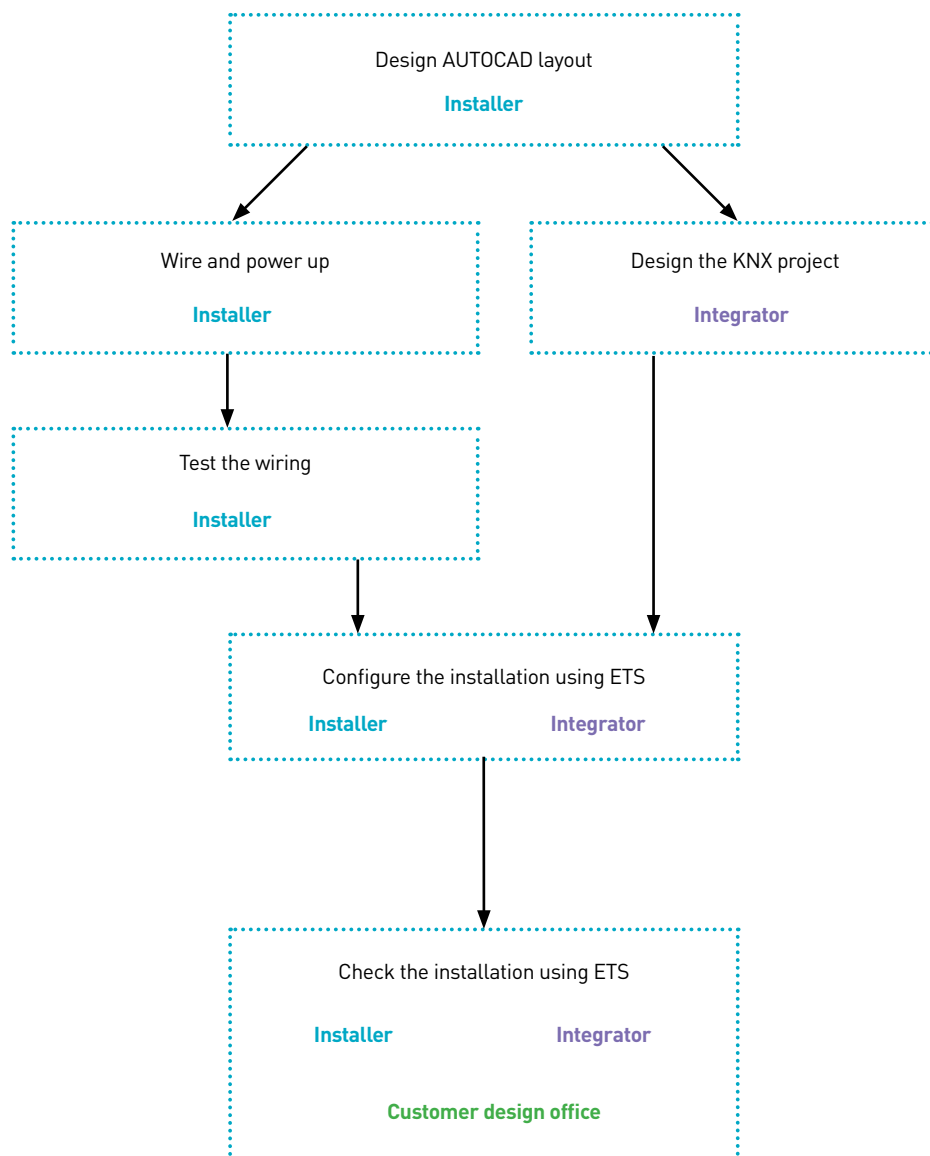

Installation

Installation diagram

In order to be able to set all the device parameters, it is essential that the following information is indicated on the installation diagram for each control point (detector, control unit, etc.) and each actuator:

- Catalogue number
- Physical device marking and/or ID given on the label
- Zone allocated to the outputs (controllers)
- Zone controlled by the control units
- KNX bus line number

A. Marking up Legrand product IDs

1. Mark up the labels

All devices with an ID must be marked up on a layout or wiring diagram.

Dual labelling can be used to mark up the installed device ID on the layout diagram.

2. Identify the information

Identify on the wiring or layout diagram which controller output (1, 2, 3 or 4, etc.) is controlled by the detector or control unit in the corresponding room or zone.

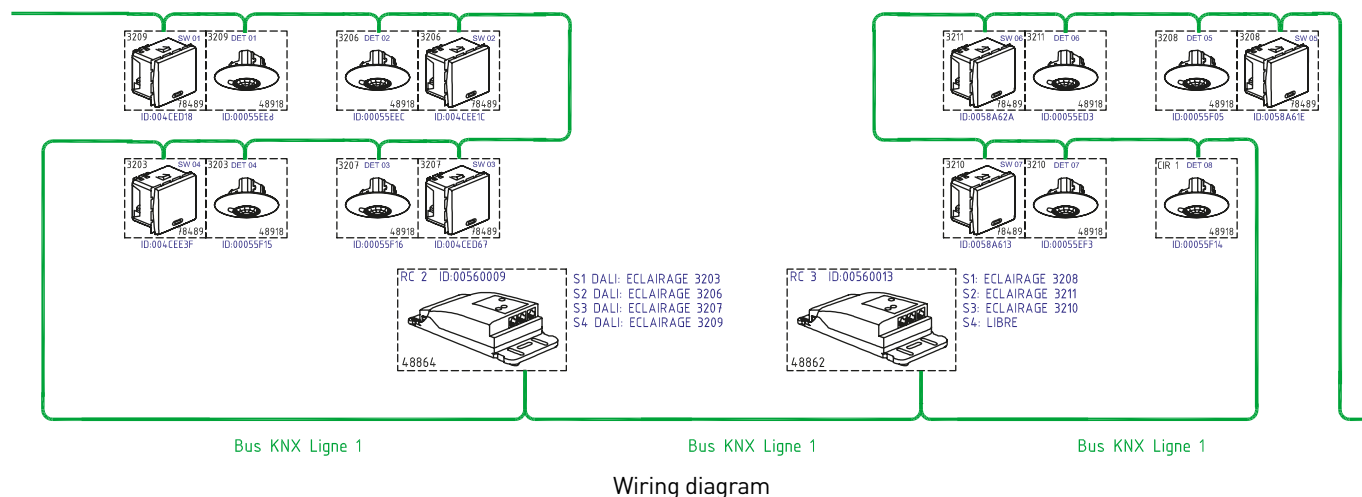

Once configured, the physical addresses given by ETS can be added to the layout diagram.

Installation continued

Sample layout diagram

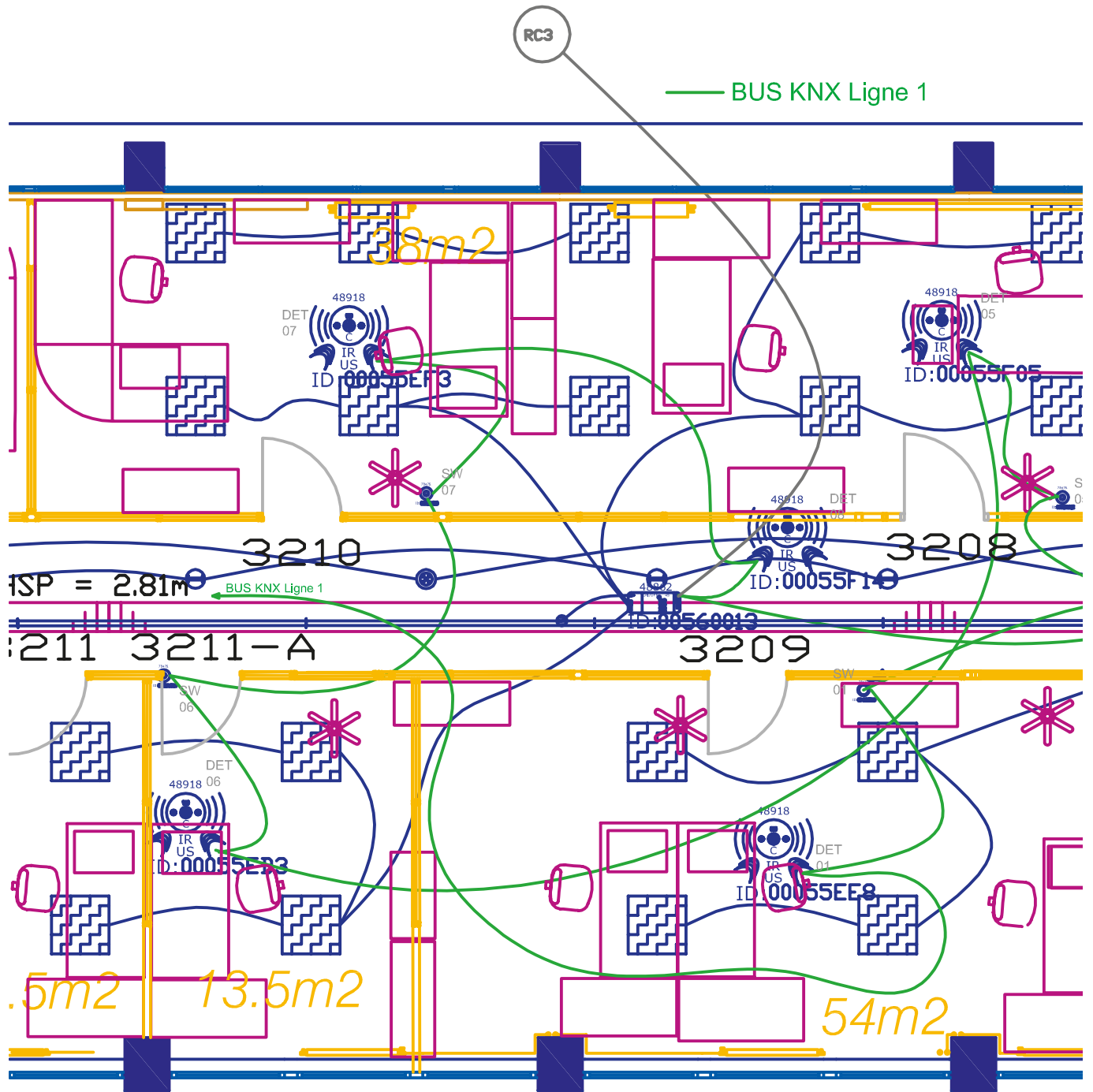

Layout diagram

Installation continued

B. B. Checking the installation wiring

1. Power up the equipment



2. Check the wiring of the peripheral devices (detectors, control units, etc.)



3. Check the wiring of the lighting lines

All the luminaires are controlled via the front panel of the controllers.

Press the push-button (control button) on the front panel: if the indicator light is on, the luminaire is functioning.

It is possible to test the dimming function by a long press of the button.



For the ceiling-mounted DALI controller Cat. No. 048888 only

For an installation comprising DALI luminaires, set the luminaire addresses before checking the lines:

Press the "DALI" button for a short press followed by a long press.

Wait for the "DALI" LED to stop flashing.



The luminaires are lit while the addresses are being set, then they turn off automatically one after the other. If the luminaires stay on, check the wiring.

Wiring

When wiring the installation, the installer must comply with all the information specified in the documentation (layout diagram, wiring diagram, description, etc.). If the device IDs are not on the plans, it is essential to stick a label for each device, stating its ID and catalogue number, onto the plan.



If any devices are not identified on the layout diagram, it will not be possible to configure them using ETS.

ETS configuration

The software used for KNX configuration is ETS3 or ETS4. It is used to create, design and test a KNX project. It offers two configuration options: the installer can either create a project in the design office and then load it on-site (OFFLINE configuration) or they can create the project directly on-site while connected to the bus (ONLINE configuration).

The method is as follows:

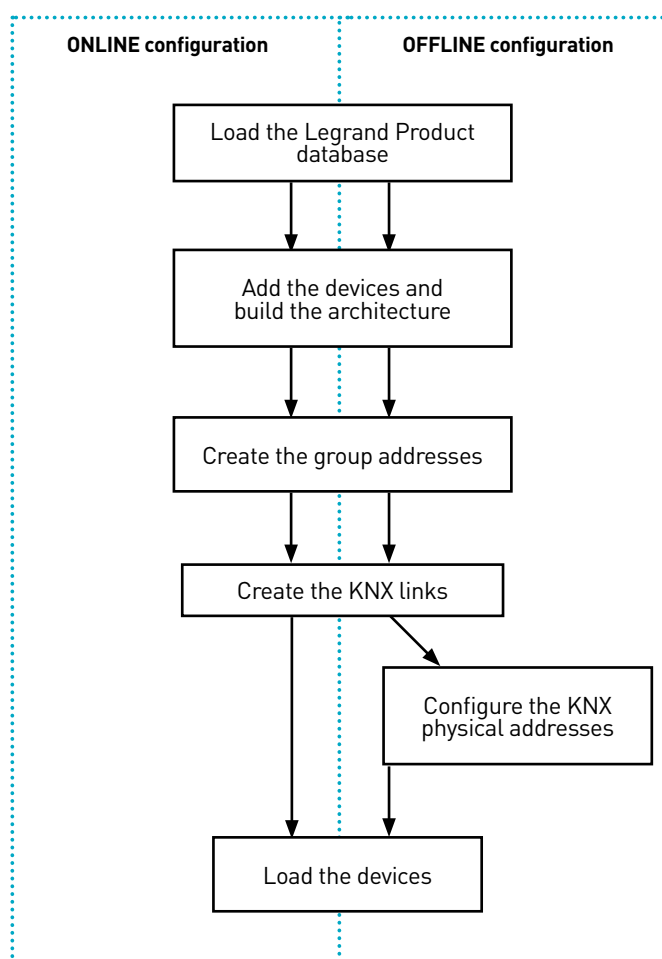

ETS configuration continued

Configuring communication

The communication media available are IP and USB. The gateways are connected to the KNX network and the configuration PC is connected to the gateway. The communication mode is selected in ETS.



The IP/KNX gateway can be configured with a fixed IP address. In this case, an address must have been previously reserved on the network by the IT department.



Note: All technical information is available at

www.legrandoc.com

Loading the product database

Download the database from the www.legrandoc.com website, then import it into ETS.

Building the product architecture

See the architecture section

Configuring the physical addresses

Once connection to the BUS has been established you can configure the physical device addresses. Each device has a unique address. To do this, select the device then load it into ETS. The devices on the control BUS are not part of the KNX BUS but are visible in ETS for configuration purposes.

Naming KNX group addresses

When setting up a Legrand supervision solution Cat. No. 0 490 00/04, it is advisable to follow the naming rules for creating KNX groups. An ETS file that follows this model can be imported into the supervisor to generate operating screens automatically.

This naming model can be viewed online at www.legrandoc.com in the “Modèle de nommage des adresses KNX” (KNX address naming model) guide.

Proposed architecture (Main and Middle Group Addresses)

Group address syntax

Zone	Device ID	Device type	Installer character string
Office	05693F	SENSOR	Window
Office	00437A92	CMD	CH1 Corridor
Office	1.7.2	NRC	OUT 1

Zone: location of the control unit or the load being controlled

ID: Device ID or physical KNX address

Type: CMD/SENSOR/NRC/etc.

Character string: Free field for the installer to assist with location



ETS configuration continued

The application examples below illustrate some standard configurations for our products.

■ Simple ON/OFF control

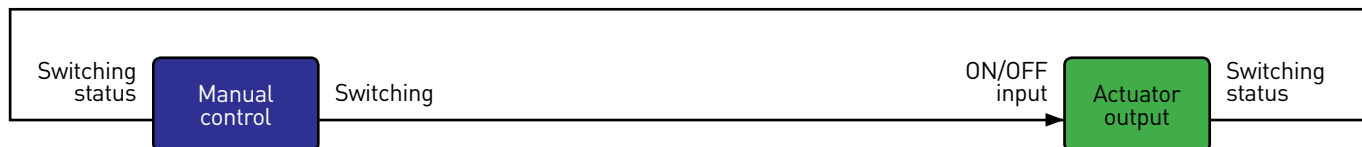

■ Simple ON/OFF control + dimming

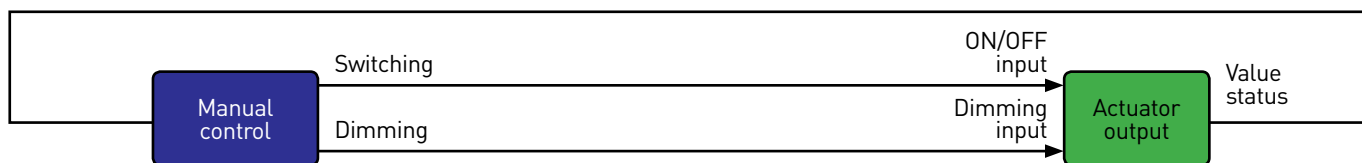

■ Scene control

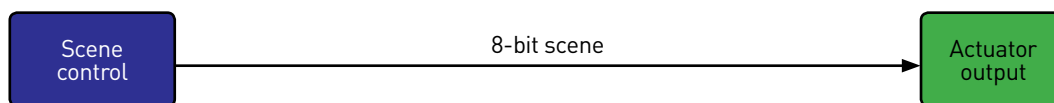

■ Detector in Auto ON/OFF mode - ON/OFF load

The diagram below applies to the following configurations:

- Lighting level with regulation
- Detection only without regulation
- Lighting level and detection without regulation
- Lighting level and detection with regulation

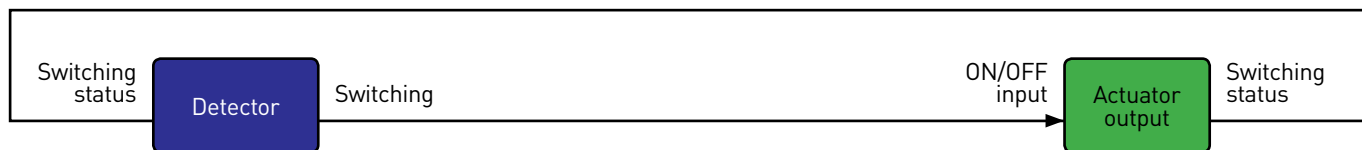

■ Detector in Auto ON/OFF mode - Dimmer load

The diagram below applies to the following configurations:

- Lighting level with regulation
- Detection only without regulation
- Lighting level and detection without regulation
- Lighting level and detection with regulation

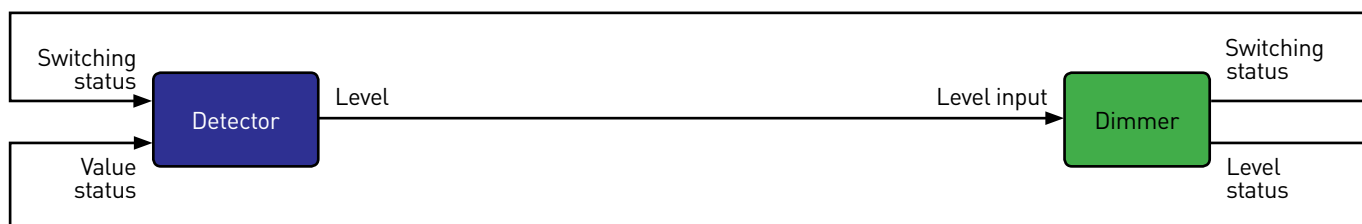

ETS configuration continued

■ Detector in Manual ON/Auto OFF mode - ON/OFF load

The diagram below applies to the following configurations:

- Lighting level with regulation
- Detection only without regulation
- Lighting level and detection without regulation
- Lighting level and detection with regulation

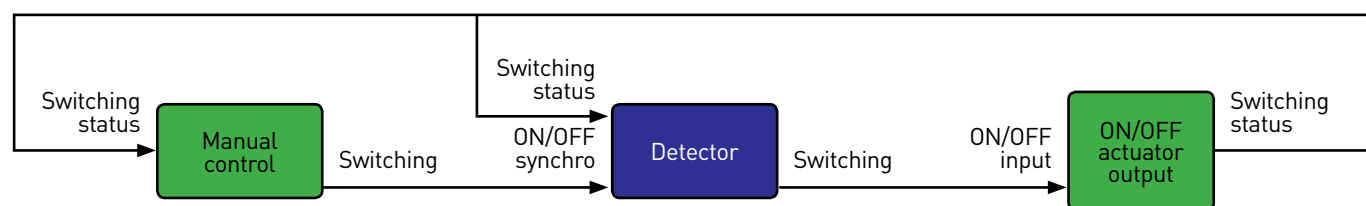

■ Detector in Manual ON/Auto OFF mode - Dimmer load

The diagram below applies to the following configurations:

- Lighting level with regulation
- Detection only without regulation
- Lighting level and detection without regulation
- Lighting level and detection with regulation

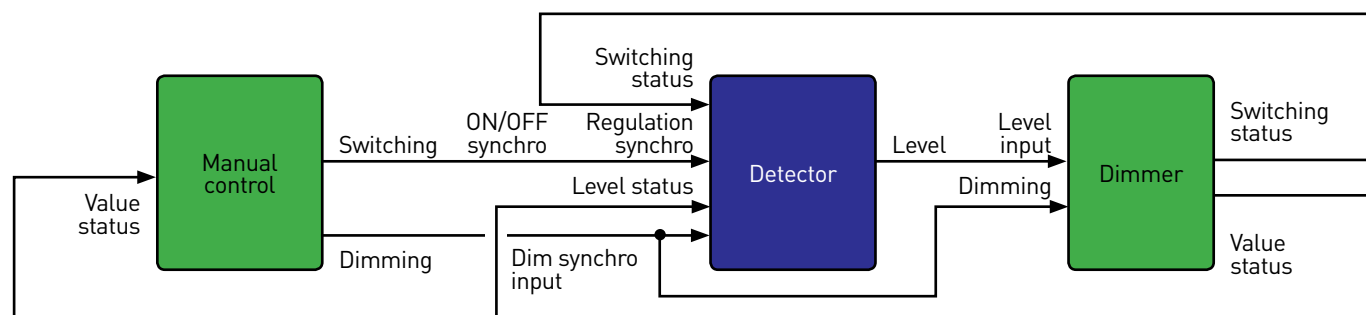

■ Master detector/Slave detector

The diagram below applies to a configuration without regulation and with ON/OFF load.

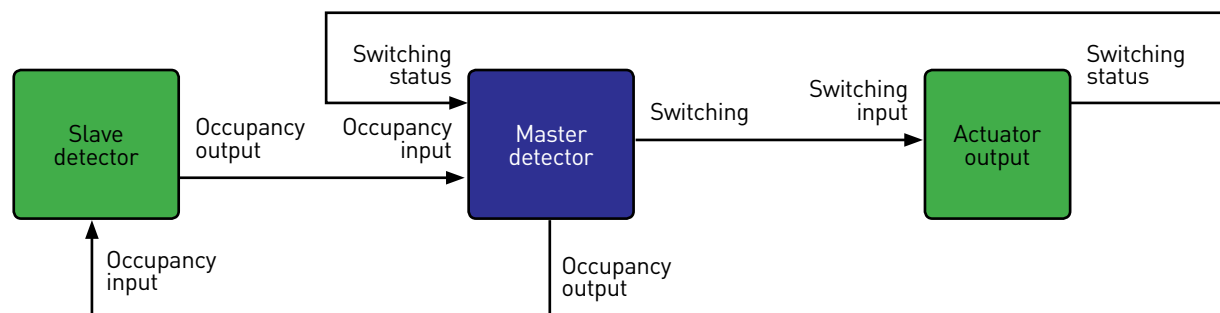

Appendix



































































Pack	Cat.Nos		Single key covers
	White	Titanium	
			For mechanisms Cat.Nos 0 675 71
			Lighting and sound distribution
5	0 681 50	0 684 50	Left-hand mounting Right-hand mounting
5	0 681 52	0 684 52	
			Lighting
5	0 681 48	0 684 48	Left-hand mounting Right-hand mounting
5	0 681 49	0 684 49	
			Dimming
5	0 681 77	0 684 77	Left-hand mounting Right-hand mounting
5	0 681 78	0 684 78	
			GEN/ON/OFF
5	0 681 55	0 684 55	Left-hand mounting Right-hand mounting
5	0 681 56	0 684 56	
			ON/OFF
5	0 682 80	0 685 80	Left-hand mounting Right-hand mounting
10	0 682 81	0 685 81	
			For roller shutters
5	0 682 69	0 685 69	Left or right-hand mounting
			Unmarked
10	0 682 03	0 685 03	Left or right-hand mounting
			STOP
1	0 682 04	0 685 04	Left-hand mounting only



















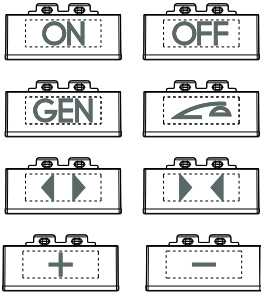

Pack	Cat.Nos		Double key covers
	White	Titanium	
			For mechanisms Cat.Nos 0 675 71
5	0 681 42	0 684 42	Lighting
5	0 681 44	0 684 44	Lighting
5	0 681 76	0 684 76	Dimming
5	0 681 80	0 684 80	GEN
5	0 681 58	0 684 58	GEN/ON/OFF
5	0 681 88	0 684 88	ON/OFF
5	0 682 59	0 685 59	For roller shutters
10	0 682 02	0 685 02	Unmarked
			Ring covers
10	0 680 00	0 683 00	To be installed in addition to single or double key covers

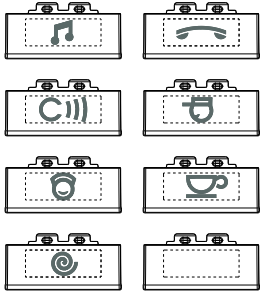

















Key cover description	Pack	Number of modules	ROUND VERSION		SQUARE VERSION			
			White ○	Magnesium ●	White ○	Magnesium ●		
Adjustment symbol, left-hand side mounting	5	1		5 745 05	5 745 06		5 744 87	5 744 86
Adjustment symbol, right-hand side mounting	5	1		5 745 07	5 745 08			
Adjustment symbol	5	2		5 745 37	5 745 38		5 744 89	5 744 88
Light symbol (either side)	5	1		5 745 17	5 745 18		5 744 75	5 744 74
Light symbol	5	2		5 745 43	5 745 44		5 744 77	5 744 76
Dimmer symbol, left-hand side mounting	5	1		5 745 20	5 745 22		5 744 69	5 744 68
Dimmer symbol, right-hand side mounting	5	1		5 745 19	5 745 21			
Dimmer symbol	5	2		5 745 41	5 745 42		5 744 71	5 744 70
Up/Down symbol (either side)	5	1		5 745 15	5 745 16		5 744 93	5 744 92
Up/Down symbol	5	2		5 745 35	5 745 36		5 744 95	5 744 94
GEN marking	5	2		5 745 39	5 745 40		5 744 73	5 744 72
GEN/ON/OFF marking, left-hand side mounting	5	1		5 745 24	5 745 26		5 744 83	5 744 82
GEN/ON/OFF marking, right-hand side mounting	5	1		5 745 23	5 745 25			
GEN/ON/OFF marking	5	2		5 745 31	5 745 32		5 744 85	5 744 84
ON/OFF marking, left-hand side mounting	5	1		5 745 28	5 745 30		5 744 79	5 744 78
ON/OFF marking, right-hand side mounting	5	1		5 745 27	5 745 29			
ON/OFF marking	5	2		5 745 33	5 745 34		5 744 81	5 744 80
Sound source selection right-hand mounting	5	1		5 745 11	5 745 12		5 744 91	5 744 90
Shutter STOP marking (either side)	5	1		5 745 45	5 745 46		5 745 47	5 745 48
Unmarked (either side)	5	1		5 745 09	5 745 10		5 744 65	5 744 64
Unmarked	5	2		5 745 13	5 745 14		5 744 67	5 744 66
Key cover with DO NOT DISTURB symbol - 2 modules	5	2		5 743 46	5 743 47		5 743 48	5 743 49
Pair of key covers with DO NOT DISTURB symbol and MAKE UP ROOM symbol	2	1		5 743 94	5 743 95		5 743 96	5 743 97

1-FUNCTION KEY COVERS			1 module Cat. Nos	2 modules Cat. Nos
NEUTRAL LIGHTABLE KEY COVERS				
 NT4915N	Neutral key cover with lightable bottom section		NT4915N	NT4915M2N
 L4915N			L4915N	L4915M2N
 N4915LN	High brightness key cover		N4915LN	N4915M2LN
KEY COVERS WITH DIFFUSER AND LIGHTABLE SYMBOL				
 NT4915AN	Key cover with light symbol		N4915AN	N4915M2AN
			NT4915AN	NT4915M2AN
			L4915AN	L4915M2AN
 NT4915BN	Key cover with staircase light symbol		N4915BN	N4915M2BN
			NT4915BN	NT4915M2BN
			L4915BN	L4915M2BN
 NT4915DN	Key cover with bell symbol		N4915DN	N4915M2DN
			NT4915DN	NT4915M2DN
			L4915DN	L4915M2DN
 NT4915FN	Key cover with key symbol		N4915FN	N4915M2FN
			NT4915FN	NT4915M2FN
			L4915FN	L4915M2FN
 NT4915M2ADN	Key cover with dimmer symbol		—	N4915M2ADN
			—	NT4915M2ADN
			—	L4915M2ADN
 NT4915DD	Key cover with “Do not disturb” symbol		N4915DD	N4915M2DD
			NT4915DD	NT4915M2DD
			L4915DD	L4915M2DD
 NT4915MR	Key cover with “Make up room” symbol		N4915MR	—
			NT4915MR	—
			L4915MR	—









2-FUNCTION KEY COVERS			1 module Cat. Nos	2 modules Cat. Nos
NEUTRAL LIGHTABLE KEY COVERS				
 N4911N	Neutral key cover with lightable top and bottom sections		N4911N	N4911M2N
 NT4911N			NT4911N	NT4911M2N
 L4911N			L4911N	L4911M2N
KEY COVERS WITH 2 DIFFUSERS AND LIGHTABLE SYMBOLS				
 NT4911AFN	Key cover with ON-OFF and GEN screen printing		N4911AFN	N4911M2AFN
			NT4911AFN	NT4911M2AFN
			L4911AFN	L4911M2AFN
 NT4911AGN	Key cover with ON/OFF markings		N4911AGN	N4911M2AGN
			NT4911AGN	NT4911M2AGN
			L4911AGN	L4911M2AGN
 NT4911AHN	Key cover with Up/Down symbols		N4911AHN	N4911M2AHN
			NT4911AHN	NT4911M2AHN
			L4911AHN	L4911M2AHN
 NT4911ADN	Key cover with + (Up) and - (Down) markings		N4911ADN	—
			NT4911ADN	—
			L4911ADN	—
 NT4911AIN	Key cover with adjustment OFF adjustment ON symbols		N4911AIN	N4911M2AIN
			NT4911AIN	NT4911M2AIN
			L4911AIN	L4911M2AIN
 NT4911BFN	Key cover with "change source" and "change track" symbols		N4911BFN	—
			NT4911BFN	—
			L4911BFN	—

KEY COVERS THAT CAN BE CUSTOMISED WITH DIFFUSERS, AVAILABLE AS A KIT			1 module Cat. Nos	2 modules Cat. Nos
NEUTRAL LIGHTABLE KEY COVERS				
1 function  can be customised	1-function key cover that can be customised with 1 diffuser*		N4915TN	N4915M2TN
			NT4915TN	NT4915M2TN
			L4915TN	L4915M2TN
2 functions  can be customised	2-function key cover that can be customised with 2 diffusers*		N4911TN	N4911M2TN
			NT4911TN	NT4911M2TN
			L4911TN	L4911M2TN
DIFFUSER KIT				
	Kit composition shown alongside (5 diffusers for each type)		N4915KIT	
			NT4915KIT	
			L4915KIT	
	Kit composition shown alongside (5 diffusers for each type)		N4915KIT	
			N4915KIT	
			N4915KIT	
	Kit with diffuser shown alongside (50 diffusers)		N4915SETBL	
			NT4915SETBL	
			L4915SETBL	

KEY COVERS WITHOUT SILK-SCREEN PRINTING - 1 AND 2 FUNCTIONS		1 module Cat. Nos	2 modules Cat. Nos
KEY-COVERS WITHOUT SILK-SCREEN PRINTING - 1 FUNCTION			
 HD4915  HD4915M2		HD4915	HD4915M2
 HC4915  HC4915/2		HC4915	HC4915/2
 HS4915  HS4915/2		HS4915	HS4915/2
KEY-COVERS WITHOUT SILK-SCREEN PRINTING - 2 FUNCTIONS			
 HD4911  HD4911M2		HD4911	HD4911M2
 HC4911  HC4911/2		HC4911	HC4911/2
 HS4911  HS4911/2		HS4911	HS4911/2

KEY COVERS WITH SILK-SCREEN PRINTING - 1 AND 2 FUNCTIONS			1 module Cat. Nos	2 modules Cat. Nos
KEY COVERS WITH SILK-SCREEN PRINTING WITH SYMBOLS - 1 FUNCTION				
 HD4915AA	OFF		HD4915AA	HD4915M2AA
			HC4915AA	HC4915/2AA
			HS4915AA	HS4915/2AA
 HD4915M2AA	ON		HD4915AB	HD4915M2AB
			HC4915AB	HC4915/2AB
			HS4915AB	HS4915/2AB
 HD4915M2AA	GEN		HD4915AC	HD4915M2AC
			HC4915AC	HC4915/2AC
			HS4915AC	HS4915/2AC
 HD4915M2AA	Dimmer		HD4915AD	HD4915M2AD
			HC4915AD	HC4915/2AD
			HS4915AD	HS4915/2AD
 HD4915M2AA	Light		HD4915BA	HD4915M2BA
			HC4915BA	HC4915/2BA
			HS4915BA	HS4915/2BA
 HD4915M2AA	Stop		HD4915AE	—
			HC4915AE	—
			HS4915AE	—
 HD4915M2AA	Bed light		HD4915BL	HD4915M2BL
			HC4915BL	HC4915/2BL
			HS4915BL	HS4915/2BL
 HD4915M2AA	Bell		HD4915BB	HD4915M2BB
			HC4915BB	HC4915/2BB
			HS4915BB	HS4915/2BB
 HD4915M2AA	Fan		HD4915BC	HD4915M2BC
			HC4915BC	HC4915/2BC
			HS4915BC	HS4915/2BC
 HD4915M2AA	Key		HD4915BD	—
			HC4915BC	—
			HS4915BC	—
 HD4915M2AA	Music		HD4915BE	HD4915M2BE
			HC4915BE	HC4915/2BE
			HS4915BE	HS4915/2BE
 HD4915M2AA	Nurse		HD4915BF	HD4915M2BF
			HC4915BF	HC4915/2BF
			HS4915BF	HS4915/2BF
 HD4915M2AA	Do not disturb		HD4915DD	HD4915M2DD
			HC4915DD	HC4915/2DD
			HS4915DD	HS4915/2DD

KEY COVERS WITH SILK-SCREEN PRINTING - 1 AND 2 FUNCTIONS			1 module Cat. Nos	2 modules Cat. Nos
KEY COVERS WITH SILK-SCREEN PRINTING WITH SYMBOLS - 1 FUNCTION (CONTINUED)				
 HD4915M2AA	Make up room		HD4915MR	—
			HC4915MR	—
			HS4915MR	—

KEY COVERS WITH SILK-SCREEN PRINTING - 1 AND 2 FUNCTIONS			1 module Cat. Nos	2 modules Cat. Nos
KEY COVERS WITH SILK-SCREEN PRINTING WITH SYMBOLS - 2 FUNCTIONS				
 HD4911M2AF	ON - OFF - GEN		HD4911AF	HD4911M2AF
			HC4911AF	HC4911/2AF
			HS4911AF	HS4911/2AF
 HD4911M2AF	ON - OFF		HD4911AG	HD4911M2AG
			HC4911AG	HC4911/2AG
			HS4911AG	HS4911/2AG
 HD4911M2AF	UP - DOWN		HD4911AH	HD4911M2AH
			HC4911AH	HC4911/2AH
			HS4911AH	HS4911/2AH
 HD4911M2AF	ON - OFF ADJUSTMENT		HD4911AI	HD4911M2AI
			HC4911AI	HC4911/2AI
			HS4911AI	HS4911/2AI
 HD4911M2AF	Light		HD4911BA	HD4911M2BA
			HC4911BA	HC4911/2BA
			HS4911BA	HS4911/2BA
 HD4911M2AF	Fan		HD4911BC	HD4911M2BC
			HC4911BC	HC4911/2BC
			HS4911BC	HS4911/2BC
 HD4911M2AF	Treble clef		HD4911BE	—
			HC4911BE	—
			HS4911BE	—
 HD4911M2AF	+ (Up) and - (Down)		HD4911AD	—
			HC4911AD	—
			HS4911AD	—

FOLLOW US ALSO ON



www.legrand.com



www.youtube.com/user/legrand



www.facebook.com/Legrand



[Google+ Legrand_news](https://plus.google.com/+Legrand_news)



twitter.com/legrand_news



pinterest.com/legrandgroup

LE05504AB_EN - October 2016



LEGRAND SNC

partnership with share capital of €6.2 million
Limoges company register no. 389 290 586

Head office

128, av. du Maréchal-de-Lattre-de-Tassigny
87045 Limoges Cedex - France

☎ : +33 (0)5 55 06 87 87 +

Fax : +33 (0)5 55 06 88 88