

PRODUCT DATASHEET

Vintage 1906 Bubble Pendant Glass Smoke 200mm

Vintage 1906® Bubble | Indoor glass luminaires, vintage style, E27 socket, round shaped lamp shade



Areas of application

- Living areas (living rooms, dining rooms, bedrooms etc.)
- Bars, restaurants

Product benefits

- Adjustable appearance thanks to use of separate available E27 lamp shapes
- Easy and quick installation

Product features

- Glass luminaires with a round shaped lamp shade
- Special vintage appearance when combined with 1906 LED or halogen lamps
- Luminaire family for various application areas
- Available in various colors



TECHNICAL DATA

Electrical data

Nominal voltage	220...240 V
Mains frequency	50...60 Hz
Protection class	I
Operating mode	Mains voltage

Dimensions & Weight

Diameter	200.00 mm
Width	100.00 mm
Height	1460.00 mm
Product weight	800.00 g

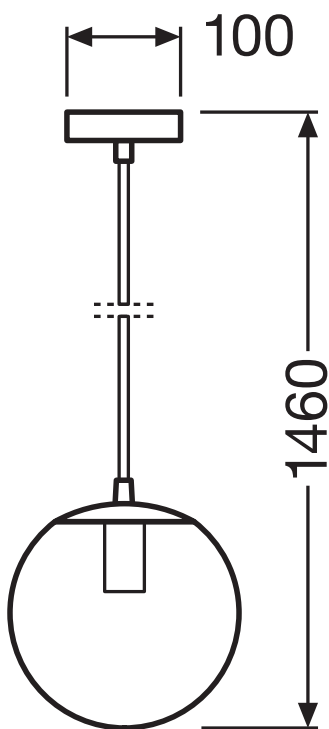

Materials & Colors

Product color	Black/Gray
Housing color	Black/Gray
Body material	Plastic METAL

Cover material	Glass
Mercury content	0.0 mg

Application & Mounting

Ambient temperature range	-20...+40 °C
Temperature range at storage	-25...+70 °C
Type of connection	Screw terminal
Type of protection	IP20
Dimmable	No
Mounting type	Surface
Mounting location	Ceiling
Application environment	Indoor
With light source	No
Holder designation	E27

Certificates & Standards

Standards	CE / EAC / REACH
Luminaire with limited surface temperature, "D sign"	No



Additional product data

Number of illuminants	1
-----------------------	---

EQUIPMENT / ACCESSORIES

- No light sources included
- Complete mounting and connecting accessories included

DOWNLOAD DATA

Documents and certificates	
	User instruction
	Declarations Of Conformity CE

LOGISTICAL DATA

Product code	Packaging unit (Pieces/Unit)	Dimensions (length x width x height)	Gross weight	Volume
4058075217409	Folding box 1	263 mm x 263 mm x 368 mm	1096.00 g	25.45 dm ³
4058075217416	Shipping box 6	800 mm x 540 mm x 380 mm	8645.00 g	164.16 dm ³

The mentioned product code describes the smallest quantity unit which can be ordered. One shipping unit can contain one or more single products. When placing an order, for the quantity please enter single or multiples of a shipping unit.

DISCLAIMER

Subject to change without notice. Errors and omission excepted. Always make sure to use the most recent release.