



Harmony SCU

HMI controllers for simple machines
with up to 16 Is/10 Os including
Ø 22 mm mounting system



Harmony

Discover [Harmony](#)

Advanced operator interface and industrial relays

Harmony operator interface and industrial relays enhance operational efficiency and equipment availability across industrial and building applications. **Harmony** includes intelligent connected products and edge terminals that visualize, gather and process data, enabling informed operator decisions

Explore our offer

- [Harmony Push Buttons and Switches](#)
- [Harmony HMI Operator Terminals, IPC and EdgeBox](#)
- [Harmony Signaling Devices](#)
- [Harmony Electrical Relays](#)
- [Harmony Safety](#)

Life Is On

Schneider
Electric



Quick access to product information

Get technical information about your product

References

Modicon TM3
I/O expansion modules for Modicon controllers
Analog I/O modules

Number and type of channels	Input range	Output range	Resolution	Aperture/interval (min.)	Reference	Weight (kg)
2 voltage/current inputs	-15...+10 VDC 0...20 mA r.t. 20 mA	16.00V or 12.00V r.t.	16.00V or 12.00V r.t.	0.001V 0.001V	TM3AI2H TM3AI2G	0.110 0.100
4 voltage/current inputs	-15...+10 VDC 0...20 mA r.t. 20 mA	16.00V or 12.00V r.t.	16.00V or 12.00V r.t.	0.001V 0.001V	TM3AI4H TM3AI4G	0.110 0.100
4 voltage/current or temperature inputs (T)	-15...+10 VDC 0...20 mA r.t. 20 mA PT100, RTD100, RTD200, RTD300	16.00V or 12.00V r.t.	16.00V or 12.00V r.t.	0.001V 0.001V	TM3AI4H TM3AI4G	0.110 0.100
4 differential temperature inputs (T)	-15...+10 VDC 0...20 mA r.t. 20 mA	16.00V or 12.00V r.t.	16.00V or 12.00V r.t.	0.001V 0.001V	TM3AI4D TM3AI4G	0.110 0.100
8 self-diagnosing	-15...+10 VDC	16.00V or 12.00V r.t.	16.00V or 12.00V r.t.	0.001V 0.001V	TM3AI8H TM3AI8G	0.110 0.100

Share Price Global (English)

Life Is On Schneider Electric

Search products, documents & more

PRODUCTS SOLUTIONS SERVICES SUPPORT ABOUT US

All products Industrial Automation and Control PLC, PAC and Dedicated Controllers Distributed Input/Output (I/O) Modules Modicon TM3

View all Modicon TM3

TM3AI2H

Module TM3 - 2 analog inputs high resolution

Show more characteristics >

Related Software >

Product Datasheet User guide Catalogue CAD Document

Characteristics Documents and Downloads Technical FAQs Additional Information Dimensions Drawings >

Main

range of product Modicon TM3

product or component type Analog input module

range compatibility Modicon M251

Each commercial reference presented in a catalog contains a hyperlink. Click on it to obtain the technical information of the product:

- Characteristics, Dimensions and drawings, Mounting and clearance, Connections and schemas, Performance curves
- Product image, Instruction sheet, User guide, Product certifications, End of life manual

Find your catalog

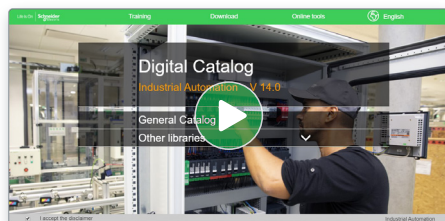

- > With just 3 clicks, you can access the Industrial Automation and Control catalogs, in both English and French
- > Consult digital automation catalogs at [Digi-Cat Online](#)

Industrial Automation

General Catalog

- Publications, Selections, PLCs, CPUs & Modules
- Books, Catalogs & Interfaces
- Signaling Devices
- HMIs (Terminals and Industrial PCs)
- Sensors & RFID System
- Motor Starters and Load Management
- Components for Motor Starters
- Variable Speed Drives & Soft Starters
- Motor Control & Robotics
- Interface, Measurement & Control Relays
- PLC, PAC & other Controllers

Publications, Selections, PLCs, CPUs & Modules

Homeless 380

Product Selector

360°

- Up-to-date catalogs
- Embedded product selectors, 360° pictures
- Optimized search by commercial references

Select your training



- > Find the right [Training](#) for your needs on our Global website
- > Locate the training center with the selector tool, using this [link](#)

Training and courses

Training by domain of expertise

- Electrical Installation and Safety
- Data Center
- Industrial Automation

General contents

Harmony SCU

Selection guide	<i>page 2</i>
■ Presentation	<i>page 4</i>
□ Operation	<i>page 4</i>
□ Configuration	<i>page 5</i>
□ Communication	<i>page 5</i>
■ Functions	<i>page 6</i>
□ Operating modes for the panels	<i>page 7</i>
■ Description	
□ Harmony HMISCU●A5 HMI controllers	<i>page 8</i>
□ Harmony HMISCU●B5 HMI controllers	<i>page 9</i>
■ Presentation of Harmony SCU HMI controllers with CANopen	<i>page 10</i>
■ References	
□ Harmony HMISCU●A5 HMI controllers	<i>page 11</i>
□ Harmony HMISCU●B5 HMI controllers	<i>page 11</i>
□ Separate parts	<i>page 12</i>
□ Replacement parts	<i>page 12</i>
□ Substitution	<i>page 13</i>
■ Product reference index	<i>page 14</i>

Harmony SCU and Magelis XBTGC HMI controllers

Applications	Display of text messages, graphic objects and mimics, control and configuration of data	
Panel type	IEC 1131-2 control function HMI controllers For control of simple machine	
Display	Type	Color TFT LCD
	Capacity	3.5" (65K colors) 5.7" (65K colors)
Data entry	Via touch screen	
	Static function keys	–
	Dynamic function keys	–
	Service keys	–
	Alphanumeric keys	–
Memory capacity	Application	128 MB Flash EPROM
	Expansion	–
Functions	Maximum number of pages and maximum number of instructions	Limited by internal Flash EPROM memory capacity
	Variables per page	Unlimited (8000 variables max.)
	Programmed logic	5 languages according to IEC 1131-2 (LD, ST, FBD, SFC, IL)
	Counting/positioning	2 x 100 KHz high speed counter inputs/2 x 50 KHz pulse train outputs
	Control (PID)	Yes
	Representation of variables	Alphanumeric, bitmap, bargraph, gauge, tank, tank level indicator, curves, polygon, button, light
	Recipes	32 groups of 64 recipes comprising 1024 ingredients max.
	Curves	Yes, with log
	Alarm logs	Yes
	Real-time clock	Built-in
I/O	Integrated	<input type="checkbox"/> 14 x 24 V ~ digital inputs <input type="checkbox"/> 2 high speed counter (HSC) inputs <input type="checkbox"/> 8 digital relay outputs <input type="checkbox"/> 2 pulse train source transistor outputs
	I/O modular expansion	–
Communication	Downloadable protocols	Modbus, Modbus TCP/IP
	Asynchronous serial link	RS-232C/RS-485 (COM1)
	USB ports	1 Host type A + 1 Device type mini-B
	Buses and networks	1 CANopen master
	Printer link	Ethernet TCP/IP (10BASE-T/100BASE-TX) USB port for parallel printer
Design software	EcoStruxure Machine Expert on Microsoft Windows® 7 Pro 32-bit/64-bit, Windows 8.1 Pro 32-bit/64-bit, and Windows 10 Pro 32-bit/64-bit (2)	
Operating system	Harmony (333 MHz RISC CPU)	
Panel type	HMISCU6A5	HMISCU8A5
Pages	11	

(1) Depending on model.
 (2) For more information, refer to EcoStruxure Machine Expert catalog [DIA3ED2180701EN](#).
 (3) For more information, refer to SoMachine catalog [DIA3ED2140110EN](#).

Applications	Display of text messages, graphic objects and mimics, control and configuration of data	
Panel type	IEC 1131-2 control function HMI controllers For control of simple process	
Display	Type	Color TFT LCD (320 x 240 pixels)
	Capacity	3.5" (65K colors) 5.7" (65K colors) 5.7" (65K colors)
Data entry	Via touch screen	
	Static function keys	–
	Dynamic function keys	–
	Service keys	–
	Alphanumeric keys	–
Memory capacity	Application	128 MB Flash EPROM
	Expansion	16 MB Flash EPROM
Functions	Maximum number of pages and maximum number of instructions	Limited by internal Flash EPROM memory capacity
	Variables per page	Unlimited (8000 variables max.)
	Programmed logic	5 languages according to IEC 1131-2 (LD, ST, FBD, SFC, IL)
	Counting/positioning	2 x 100 KHz high speed counter inputs/2 x 50 KHz pulse train outputs
	Control (PID)	Yes
	Representation of variables	Alphanumeric, bitmap, bargraph, gauge, tank, tank level indicator, curves, polygon, button, light
	Recipes	32 groups of 64 recipes comprising 1024 ingredients max.
	Curves	Yes, with log
	Alarm logs	Yes
	Real-time clock	Built-in
I/O	Integrated	<input type="checkbox"/> 6 x 24 V ~ digital inputs <input type="checkbox"/> 2 high speed counter (HSC) inputs <input type="checkbox"/> 6 digital relay outputs <input type="checkbox"/> 2 pulse train source transistor outputs <input type="checkbox"/> 2 x 13-bit analog inputs (Voltage/current) <input type="checkbox"/> 2 x 16-bit analogue temperature inputs (TC/PT100-1000) <input type="checkbox"/> 2 x 12-bit analog outputs (Voltage/current)
	I/O modular expansion	<input type="checkbox"/> 16 x 24 V ~ digital inputs <input type="checkbox"/> 16 sink or source transistor outputs (1)
Communication	Downloadable protocols	Modbus, Modbus TCP/IP
	Asynchronous serial link	Modbus, Modbus TCP/IP and for PLC brands: Mitsubishi, Omron, Allen-Bradley and Siemens
	USB ports	RS-232C/RS-485 (COM1)
	Buses and networks	1 Host type A + 1 Device type mini-B 1 CANopen master
	Printer link	Ethernet TCP/IP (10BASE-T/100BASE-TX) USB port for parallel printer
Design software	EcoStruxure Machine Expert on Microsoft Windows® 7 Pro 32-bit/64-bit, Windows 8.1 Pro 32-bit/64-bit, and Windows 10 Pro 32-bit/64-bit (2)	
Operating system	Harmony (333 MHz RISC CPU)	
Panel type	HMISCU6B5	HMISCU8B5
Pages	11	

SoMachine on Windows XP Professional and Windows 7 Professional 32-bit/64-bit (3).
 Harmony (131 MHz RISC CPU)

XBTGC2330T
 XBTGC2330U

For more information, refer to Magelis XBTGC catalog [DIA5ED2130615EN](#).

Harmony SCU

HMI controllers for simple machines with up to 16 Is/10 Os

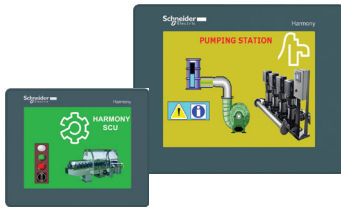

Harmony SCU

Presentation

The ultra-compact range of Harmony SCU HMI controllers are part of Schneider Electric's Flexible Machine Control concept, a key element in MachineStruxure™.

The Harmony SCU HMI controllers offer brings together Human Machine Interface and control functions within a single product. This reduces the amount of equipment required and the associated costs throughout the life cycle of the machine.

The Harmony SCU integrate, as standard, all their functions. They benefit, in particular, from the same innovation as the Harmony STU panels range: Mounting via a 22 mm diameter hole (pushbutton type) which considerably simplifies installation (see page 8).

Of modular design, this range comprises:

- 2 complete Harmony SCU products for the control of simple machines, comprising:
 - A 3.5" or 5.7" 65 k color TFT Screen module
 - A Controller module with 16 integrated digital inputs/10 integrated digital outputs
- 2 complete Harmony SCU products for the control of simple processes, comprising:
 - A 3.5" or 5.7" 65 k color TFT Screen module
 - A Controller module with 8 integrated digital inputs/8 integrated digital outputs and 4 integrated analog inputs/2 integrated analog outputs

The screen modules and Controller modules (for simple machines or processes) are also available separately as replacement parts. Harmony SCU operate with the same screen modules as Harmony STU panels, which simplifies upgrading of an installation (only the rear module needs to be replaced). A wide choice of communication interfaces is also integrated: USB port, serial link, Ethernet and CANopen.

Operation

With their fast multitasking processors, the HMI controllers combine HMI and control functions and share the same screen and communication features and dimensions. The internal memory can be freely used by both the HMI function and the control function.

Processing is split 75% on the HMI part and 25% on the control part. The processing can be configured for 3 tasks, including 1 master task.

Green product

Harmony SCU is a Green Premium product designed to have a smaller carbon footprint:

- Transparent environment information
- Complaint to RoHS and REACH
- Life cycle analysis, compliant with ISO14025
- Circular instructions.



Harmony SCU

HMI controllers for simple machines with up to 16 Is/10 Os



SoMachine



EcoStruxure Machine Expert



Vijeo Designer (included in SoMachine)

Configuration

Harmony SCU are configured using Schneider Electric's unique machine automation software, SoMachine and EcoStruxure Machine Expert. This software, combining both HMI and control functions, is based on Vijeo Designer software (2) running on Microsoft Windows version 7, 8.1 and 10 Professional. SoMachine software (2) boasts an advanced user interface with many configurable windows, enabling unique projects to be developed quickly and easily.

Communication

Examples of communication architectures

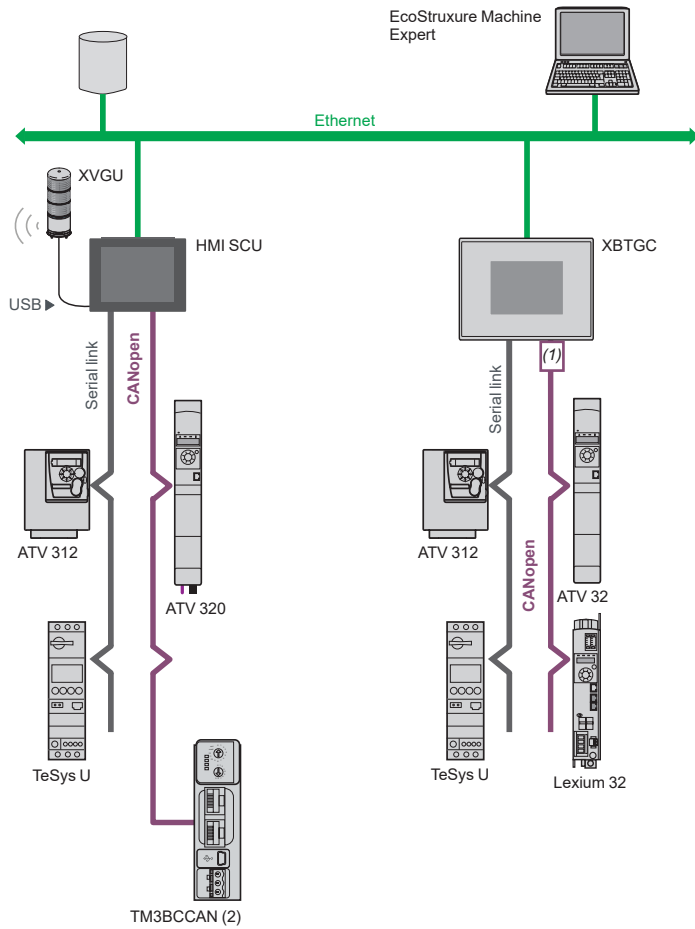

The HMI controllers panels communicate with automation devices through one integrated serial link using the following communication protocols:

- Harmony SCU HMI controllers
 - Schneider Electric Modbus protocol managed by Control part
 - Schneider Electric (Uni-TE , Modbus) protocols managed by HMI part
 - Third -party protocols (Mitsubishi Electric, Omron , Allen-Bradley and Siemens) managed by HMI part
- Magelis XBTGC HMI controllers
 - Schneider Electric (Uni-TE, Modbus) protocols managed by HMI part
 - Third-party protocols Mitsubishi Electric, Omron, Allen-Bradley and Siemen managed by HMI part

They can be connected to Ethernet TCP/IP networks with the Modbus TCP protocol or a third-party protocol managed by HMI part, and can be used as the CANopen master to control all the peripherals which can be connected on this bus.

In addition, on Harmony SCU, the Modbus TCP Slave protocol is supported by Control part with Ethernet network.

(1) With XBTZGCCAN CANopen master module.

(2) For more information please refer to Vijeo Designer software catalog [DIA5ED2130614EN](#) and SoMachine software catalog [DIA3ED2140110EN](#).

(3) Available Q3 2020.

Harmony SCU

HMI controllers for simple machines with up to 16 Is/10 Os

Functions

Harmony SCU are part of Schneider Electric's Flexible Machine Control concept, a key element in MachineStruxure.

Harmony SCU offer the following HMI functions:

- Display of animated mimics with 8 types of animation (pressing the touch panel, color changes, filling, movement, rotation, size, visibility and value display)
- Control, modification of numeric and alphanumeric values
- Display of current time and date
- Real-time curves and trend curves with log
- Alarm display, alarm log and management of alarm groups
- Multiwindow management
- Page calls initiated by the operator
- Multilingual application management (10 languages simultaneously)
- Recipe management
- Data processing via Java script
- Application support and USB key external memory logs
- Management of serial printers, barcode readers

Harmony SCU have been designed for Transparent Ready architectures and equipment (combination of Web and Ethernet TCP/IP technologies).

With the WebGate function, it is possible to control or carry out maintenance remotely.

Eventually, Harmony SCU will enable a smartphone or a PC tablet to be remotely connected to the HMI application.

Harmony SCU offer the following HMI functions:

- Execution of programmed logic sequences with the five IEC 1131-2 languages (LD, ST, FBD, SFC, IL)
- Management of equipment on the CANopen fieldbus

In addition to the aforementioned functions, these HMI controllers enable management of:

- Integrated digital I/O
- Integrated analog I/O: Voltage, current and temperature (thermocouple, PT100, PT1000)
- 2 high speed counter (HSC) inputs, 100 kHz 1 channel or 50 kHz 2 channel
- 2 pulse train fast outputs, PTO/PWM 50 kHz

Harmony SCU

HMI controllers for simple machines with up to 16 Is/10 Oss

Operating modes for the panels

The following illustrations show the equipment that can be connected to Harmony SCU and Magelis XBTGC controllers according to their two operating modes.

Edit mode

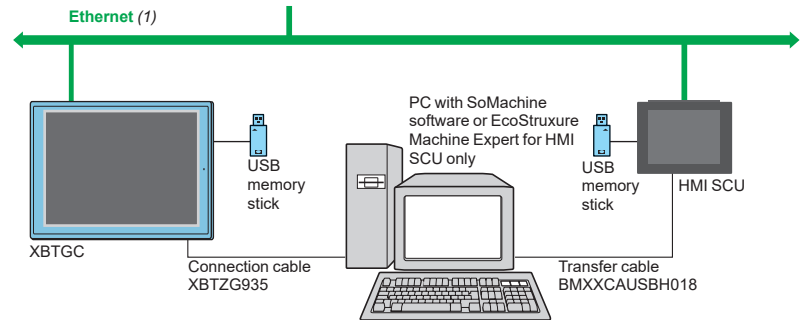

Run mode

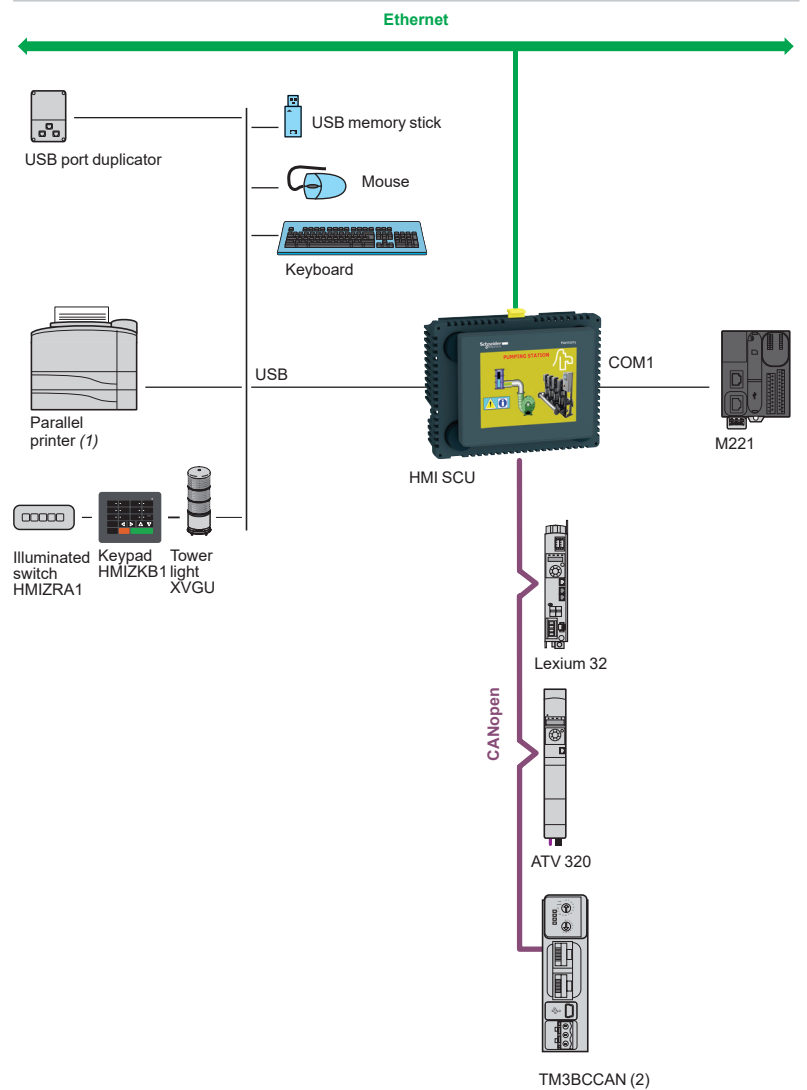

(1) Should be a Hewlett Packard printer via a USB/PIO converter.
 (2) Available Q3 2020.

Harmony SCU

HMI controllers for simple machines with up to 16 Is/10 Os

Harmony HMISCU●A5 HMI controllers

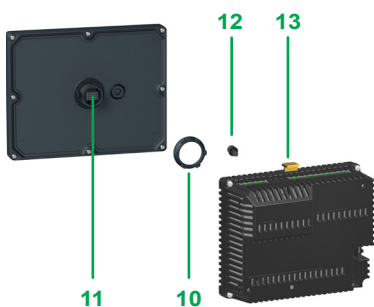
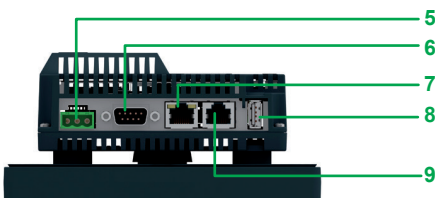
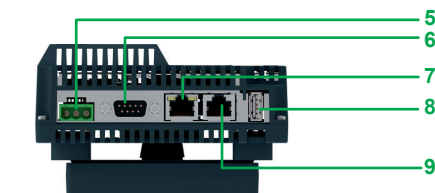
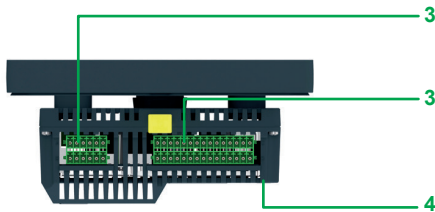
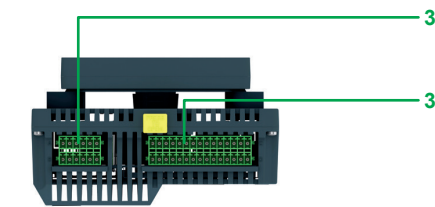

Description

Harmony HMISCU●A5 HMI controllers

Front Panel

To control simple machines, Harmony SCU has the following on the front panel:

- 1 A 3.5" touch screen for displaying mimics (color TFT LCD)
- or
- 2 A 5.7" touch screen for displaying mimics (color TFT LCD)

Upper rear panel

The upper rear panel has the following:

- 3 Four removable terminal blocks for 16 digital inputs including 2 high speed counter (HSC) inputs (100 kHz 1 channel or 50 kHz 2 channel), 8 digital relay outputs and 2 source transistor outputs (PTO/PWM 50 kHz or 20 kHz pulse train if HSC used)

Lower rear panel

The lower rear panel has the following:

- 4 A USB mini-B device connector for application transfer (on left-hand side of panel)
- 5 A removable screw terminal block for 24 V $\bar{\text{---}}$ power supply
- 6 A 9-way SUB-D connector for CANopen link, fitted with an LED for signalling power supply and system operation status
- 7 An RJ45 connector for Ethernet TCP/IP, 10BASE-T/100BASE-TX link
- 8 A Type A USB master connector for:
 - Connection of a peripheral device
 - Connection of a USB memory stick
 - Application transfer
- 9 An RJ45 male connector for RS-232C or RS-485 serial link connection to PLCs (COM1)

Fixing system

Harmony SCU consist of a front module (comprising the screen) and a rear module (comprising the CPU plus terminals and connectors). The two modules are fixed together via a hole measuring 22 mm in diameter.

The fixing system contains the following elements:

- 10 A fixing nut
- 11 A seal
- 12 An anti-rotation tee (can be used as an option)
- 13 A release mechanism: Simply press to separate the two modules once they have been fixed together

This system is included with the complete products (see [page 11](#)).

Note: The 2 modules can also be mounted separately: Using a remote connection cable enables the rear module and the front module to be separated and the Controller module mounted on DIN rail (see [page 11](#)).

Harmony SCU

HMI controllers for simple machines with up to 16 Is/10 Os

Harmony HMISCU●B5 HMI controllers

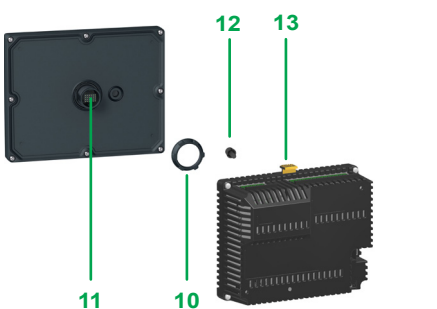
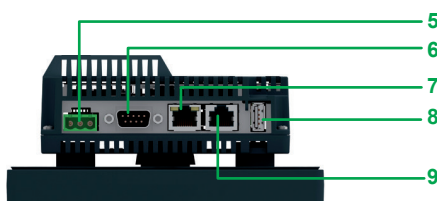
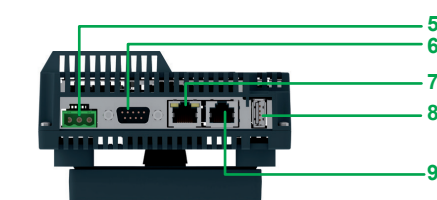
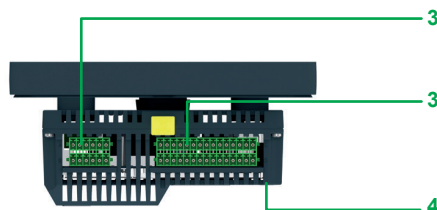
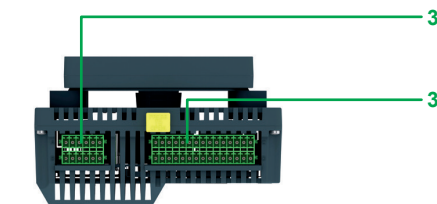
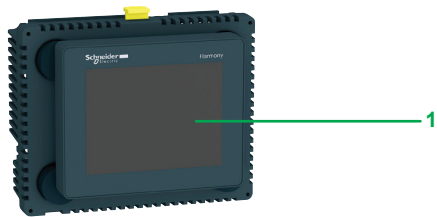

Description

Harmony HMISCU●B5 HMI controllers

Front panel

To control simple processes, Harmony SCU has the following on the front panel:

- 1 A 3.5" touch screen for displaying mimics (color TFT LCD)
- or
- 2 A 5.7" touch screen for displaying mimics (color TFT LCD)

Upper rear panel

The upper rear panel has the following:

- 3 Four removable terminal blocks for 8 digital inputs including 2 fast HSC inputs (100 KHz 1 channel or 50 kHz 2 channel), 6 digital relay outputs, 2 transistor source outputs (PTO/PWM 50 kHz or 20 kHz pulse train if HSC used), 2 analog inputs (voltage, current), 2 temperature inputs (Thermocouple, PT100, PT1000) and 2 analog outputs (voltage, current)

Lower rear panel

The lower rear panel has the following:

- 4 A USB mini-B device connector for application transfer (on left-hand side of panel)
- 5 A removable screw terminal block for 24 V $\bar{\square}$ power supply
- 6 A 9-way SUB-D connector for CANopen link, fitted with an LED for signalling power supply and system operation status
- 7 An RJ45 connector for Ethernet TCP/IP, 10BASE-T/100BASE-TX link
- 8 A Type A USB master connector for:
 - Connection of a peripheral device
 - Connection of a USB memory stick
 - Application transfer
- 9 An RJ45 male connector for RS-232C or RS-485 serial link connection to PLCs (COM1)

Fixing system

Harmony HMI SCU consist of a front module (comprising the screen) and a rear module (comprising the CPU plus terminals and connectors).

The two modules are fixed together via a hole measuring 22 mm in diameter.

The fixing system contains the following elements:

- 10 A fixing nut
- 11 A seal
- 12 An anti-rotation tee (can be used as an option)
- 13 A release mechanism: Simply press to separate the two modules once they have been fixed together

This system is included with the complete products (see [page 11](#)).

Note: The 2 modules can also be mounted separately: Using a remote connection cable enables the rear module and the front module to be separated and the Controller module mounted on DIN rail (see [page 11](#)).

Harmony SCU

HMI controllers for simple machines with up to
16 Is/10 Os

CANopen

Presentation

Harmony SCU Small HMI controllers integrate the CANopen bus master function.

SoMachine and EcoStruxure Machine Expert software are used to configure the CANopen machine bus (1) for the Harmony SCU HMI controllers (1).

Example architecture

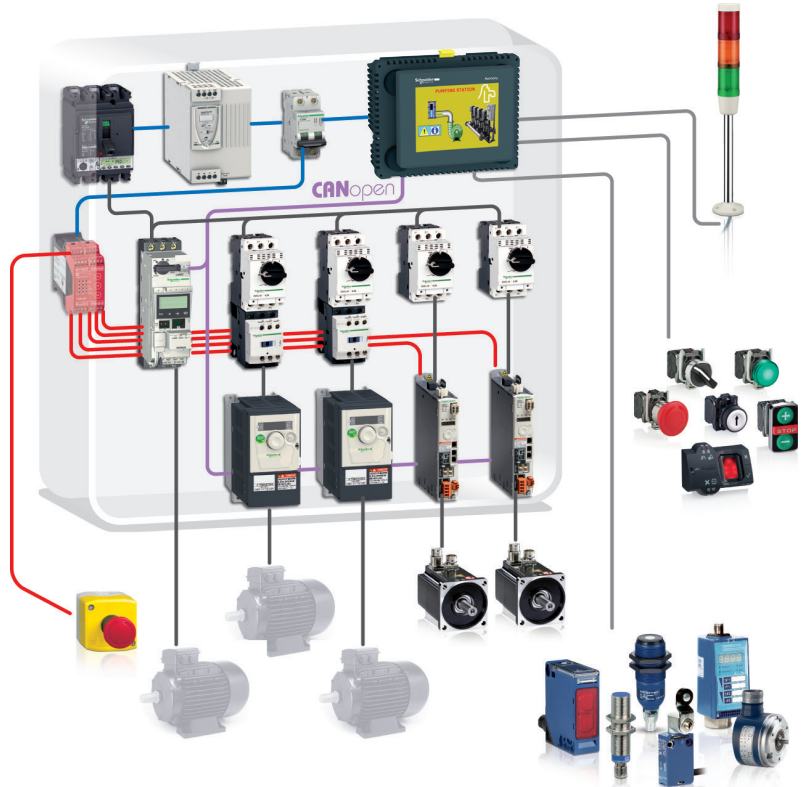

The above configuration shows an example architecture based on the Harmony SCU Small HMI controllers which provide the CANopen bus master function. The CANopen bus is made up of a master station, a Harmony SCU Small HMI Controller and slave stations. The master is responsible for the configuration, exchanges and diagnostics to the slaves.

The various services offered are:

- One or more profiles are supplied for Schneider Electric slaves such as ATV 312/61/71 variable speed drives and Lexium 32 servo drives. This makes it possible to configure the slave according to a predefined mode. Profiles provide the user with a defined operating mode so there is no need to check how the mode is configured.
- For third-party slaves:
 - The user can choose from a list which can be modified. This simply involves importing an EDS-type (Electronic Data Sheet) description file.
 - The slave can be positioned on the bus: The slave number, speed, monitoring, etc. can be defined.
 - The user can select variables from the list of variables managed by the slave.
 - A link between variables and the data exchanged.
 - Symbolization of data exchanged.

The CANopen bus is used to manage various slaves such as:

- Digital and analog slaves
- Variable speed drives, motor starters, etc.

(1) For more information on SoMachine software and CANopen bus, please refer to our website www.schneider-electric.com.

(1) For more information on CANopen bus references, please refer to CANopen for machines catalog DIA3ED2160104EN.

Harmony SCU

HMI controllers for simple machines with up to 16 Is/10 Os

Harmony HMISCU●A5 and HMISCU●B5



PF12219_R
HMISCU6●5



PF12220_R
HMISCU8●5

Harmony HMISCU●A5 HMI controllers for control of simple machines (1)

Complete products 24 V --- (Screen module + Controller module)

Type of screen	No. of ports	Application memory capacity	Compact Flash memory	Integrated I/O	No. of Ethernet ports	Reference	Weight kg/lb
3.5" QVGA color TFT	2 USB 1 COM1 1 CANopen	128 MB	No	16 digital I/ 10 digital O	1	HMISCU6A5	0.512/ 1.129
5.7" QVGA color TFT	2 USB 1 COM1 1 CANopen	128 MB	No	16 digital I/ 10 digital O	1	HMISCU8A5	0.764/ 1.684

Harmony HMISCU●B5 HMI controllers for control of simple processes (1)

Type of screen	No. of ports	Application memory capacity	Compact Flash memory	Integrated I/O	No. of Ethernet ports	Reference	Weight kg/lb
Complete products 24 V --- (Screen module + Controller module)							
3.5" QVGA color TFT	2 USB 1 COM1 1 CANopen	128 MB	No	8 digital I/8 digital O 4 analog I/ 2 analog O	1	HMISCU6B5	0.551/ 1.215
5.7" QVGA color TFT	2 USB 1 COM1 1 CANopen	128 MB	No	8 digital I/8 digital O 4 analog I/ 2 analog O	1	HMISCU8B5	0.803/ 1.770

(1) Mounting system for Ø 22 mm hole, power supply and I/O connectors, locking device for USB connector and instruction sheet included with panels. The setup documentation for Harmony SCU is supplied in electronic format with the SoMachine software (please refer to our website www.schneider-electric.com).

Harmony SCU

HMI controllers for simple machines with up to 16 Is/10 Os

Separate parts, Replacement parts

105872-35M



XBTZGUSB

PF122208-30-Q



HMIZSURDP

Separate parts

Description	Compatibility	Reference	Weight kg/lb
Protective sheets (5 peel-off sheets)	HMISCU6●●	HMIZS61	–
	HMISCU8●●	HMIZS62	–

Designation	Description	Length m/ft	Reference	Weight kg/lb
Remote USB port location for type A terminal	Enables the USB port to be located remotely on the rear of the HMI terminal on a panel or cabinet door (Ø 21 mm fixing device)	1.0/3.28	XBTZGUSB	–
Remote USB port location for mini type B terminal		–	HMIZSUSBB	–
Remote Controller module connection cable	Enables separate mounting of the Controller module and Screen module on DIN rail (for example, inside an enclosure)	3.0/9.84	HMIZSURDP	–
		5.0/16.40	HMIZSURDP5	–
		10/32.81	HMIZSURDP10	–
Cable for transferring application to PC	USB type connector	1.8/5.90	BMXXCAUSBH018	–
Accessories kit (compatible with all SCU small controllers)	Contains: <ul style="list-style-type: none"> ■ An anti-rotation tee ■ A USB A type clip ■ A USB mini-B type clip ■ An adaptor panel for mounting on an enclosure of 1 mm in thickness 	–	HMIZSUKIT	–

Replacement parts

Description	For use with	Reference	Weight kg/lb
Direct I/O connector	All Harmony SCU	HMIZSDIO	–
3.5" Screen module	Controller modules HMISAC and HMISBC	HMIS65	0.153/ 0.337
5.7" Screen module	Controller modules HMISAC and HMISBC	HMIS85	0.405/ 0.893
Simple machine Controller module	Screen modules HMIS65 (3.5") and HMIS85 (5.7")	HMISAC	0.359/ 0.791
Simple process Controller module	Screen modules HMIS65 (3.5") and HMIS85 (5.7")	HMISBC	0.398/ 0.877
Fixing nuts	Set of 10 Ø 22 mm nuts (the front module of the SCU small controller is fixed on the enclosure using a Ø 22 mm nut, see page 8)	ZB5AZ901	–
Tightening tool	For tightening fixing nut	ZB5AZ905	–

Harmony SCU

HMI controllers for simple machines with up to 16 Is/10 Os

Equivalent product table

Equivalent product table between XBTGC panels and HMISCU panels

While upgrading Magelis XBTGC range to Harmony SCU range, the following parameters must be considered:

- Magelis XBTGC is only configurable by SoMachine software, Harmony SCU can be configured by SoMachine and EcoStruxure Machine Expert software.
- Harmony SCU has the same USB Host interface of Magelis XBTGC with a second USB device mini-B port.
- CANopen Master managing 16 slaves via an external module on XBTGC is now embedded directly on Harmony SCU with same connector SubD9.
- One serial port and Ethernet port are directly available on Harmony SCU.
- Harmony SCU supports more application memory (128 MB) compared to Magelis XBTGC (16 MB).
- Harmony SCU has less backup memory (128 KB) compared to Magelis XBTGC (512 KB).
- Harmony SCU and Magelis XBTGC have same inputs. Outputs on Harmony SCU are based on relays (except 2 with transistors) when compared to Magelis XBTGC with only transistor outputs.
- Harmony SCU doesn't support TM2 modules directly. To keep these TM2 modules on Harmony SCU, an OTB Block or a BusCoupler on CANopen can be used.
- Magelis XBTGC supports four inputs for HSC 100 KHz and Harmony HMISCU supports only two inputs for HSC 100 KHz.
- Magelis XBTGC supports four inputs for PTO 65 KHz and Harmony HMISCU supports only two inputs for PTO 50 KHz.

Old Magelis XBTGC HMI controllers (1)		Replaced by Harmony SCU HMI controllers		Compatibility
Description	Reference	Description	References	
3.8" STN screen, amber or red	XBTGC1100T XBTGC1100U	3.5" QVGA color TFT	HMISCU6A5	No cut-out, push-button mounting system Display with identical resolution and 64 K colors
5.7" STN screen, black and white mode	XBTGC2120T XBTGC2120U	5.7" QVGA color TFT	HMISCU8A5	No cut-out, push-button mounting system Display with identical resolution and 64 K colors

(1) XBTGC2330 must be used if HSC and PTO cannot be converted to HMISCU or if TM2 modules need to be supported directly.
 (2) Available Q3 2020.

B	
BMXXCAUSBH018	12
H	
HMIS65	12
HMIS85	12
HMISAC	12
HMISBC	12
HMISCU6A5	11 13
HMISCU6B5	11
HMISCU8A5	11 13
HMISCU8B5	11
HMIZS61	12
HMIZS62	12
HMIZSDIO	12
HMIZSUKIT	12
HMIZSURDP	12
HMIZSURDP10	12
HMIZSURDP5	12
HMIZSUSBB	12
X	
XBTGC1100T	13
XBTGC1100U	13
XBTGC2120T	13
XBTGC2120U	13
XBTZGUSB	12
ZB5AZ901	12
ZB5AZ905	12

Life Is On



Learn more about our products at
www.schneider-electric.com/hmi

The information provided in this documentation contains general descriptions and/or technical characteristics of the performance of the products contained herein. This documentation is not intended as a substitute for and is not to be used for determining suitability or reliability of these products for specific user applications. It is the duty of any such user or integrator to perform the appropriate and complete risk analysis, evaluation and testing of the products with respect to the relevant specific application or use thereof. Neither Schneider Electric nor any of its affiliates or subsidiaries shall be responsible or liable for misuse of the information contained herein.

Design: Schneider Electric
Photos: Schneider Electric

Schneider Electric Industries SAS

Head Office
35, rue Joseph Monier - CS 30323
F-92500 Rueil-Malmaison Cedex
France

DIA5ED2130505EN
October 2021 - V6.0