

# Auxiliary Relay (Contactor Relay) J7KCA Series

Same shape as J7KC magnetic contactors Ideal for standardizing panel design



- Push-In Plus wiring Technology saves Wiring and Maintenance time
- World's smallest size (\*1)
- High Contact Reliability (Min. 5 VDC, 3 mA) by Bifurcated contacts
- Combination with Auxiliary contact units to configure a wide variety of contact variations
- Coil surge absorber unit installed as standard (\*2)
- Auxiliary Relay with mechanically linked contacts according to EN 60947-5-1 in safety applications, combined with AUX contact blocks, whose switching function is controlled by a safety-related system
- Certified as compliant with the main safety standards

For the most recent information on models that have been certified for safety standards, refer to your OMRON website.

\*1. According to OMRON investigation, as of August 2019. For push-in models.  
\*2. DC operated

Refer to *Safety Precautions* on page 10.

## Model Number Structure

**Model Number Legend** Order according to the format described in Ordering Information.

J7KCA- □□ □□□□□□  
(1) (2)

### (1) Contact configuration

Code	Contact configuration
40	4PST-4NO
31	4PST-3NO 1NC
22	4PST-2NO 2NC

### (2) Coil voltage

Operation	Code	Coil voltage
AC-operated	AC 24	24 VAC
	AC 48	48 VAC
	AC 100	100 VAC
	AC 110	110 VAC
	AC 120	120 VAC
	AC 200	200 VAC
	AC 220	220 VAC
	AC 230	230 VAC
	AC 240	240 VAC
	AC 380	380 VAC
	AC 400	400 VAC
	AC 440	440 VAC
	AC 500	500 VAC

Operation	Code	Coil voltage
DC-operated	DC 12	12 VDC
	DC 24	24 VDC
	DC 48	48 VDC
	DC 60	60 VDC
	DC 100	100 VDC
	DC 110	110 VDC
	DC 120	120 VDC
	DC 200	200 VDC
	DC 210	210 VDC
	DC 220	220 VDC

# J7KCA Series

## Ordering Information

### Main unit

#### Contacting relay

Coil rating	Contact configuration	Model
24 VAC	4PST-4NO	J7KCA-40 AC24
	4PST-3NO 1NC	J7KCA-31 AC24
	4PST-2NO 2NC	J7KCA-22 AC24
48 VAC	4PST-4NO	J7KCA-40 AC48
	4PST-3NO 1NC	J7KCA-31 AC48
	4PST-2NO 2NC	J7KCA-22 AC48
100 VAC	4PST-4NO	J7KCA-40 AC100
	4PST-3NO 1NC	J7KCA-31 AC100
	4PST-2NO 2NC	J7KCA-22 AC100
110 VAC	4PST-4NO	J7KCA-40 AC110
	4PST-3NO 1NC	J7KCA-31 AC110
	4PST-2NO 2NC	J7KCA-22 AC110
120 VAC	4PST-4NO	J7KCA-40 AC120
	4PST-3NO 1NC	J7KCA-31 AC120
	4PST-2NO 2NC	J7KCA-22 AC120
200 VAC	4PST-4NO	J7KCA-40 AC200
	4PST-3NO 1NC	J7KCA-31 AC200
	4PST-2NO 2NC	J7KCA-22 AC200
220 VAC	4PST-4NO	J7KCA-40 AC220
	4PST-3NO 1NC	J7KCA-31 AC220
	4PST-2NO 2NC	J7KCA-22 AC220
230 VAC	4PST-4NO	J7KCA-40 AC230
	4PST-3NO 1NC	J7KCA-31 AC230
	4PST-2NO 2NC	J7KCA-22 AC230
240 VAC	4PST-4NO	J7KCA-40 AC240
	4PST-3NO 1NC	J7KCA-31 AC240
	4PST-2NO 2NC	J7KCA-22 AC240
380 VAC	4PST-4NO	J7KCA-40 AC380
	4PST-3NO 1NC	J7KCA-31 AC380
	4PST-2NO 2NC	J7KCA-22 AC380
400 VAC	4PST-4NO	J7KCA-40 AC400
	4PST-3NO 1NC	J7KCA-31 AC400
	4PST-2NO 2NC	J7KCA-22 AC400
440 VAC	4PST-4NO	J7KCA-40 AC440
	4PST-3NO 1NC	J7KCA-31 AC440
	4PST-2NO 2NC	J7KCA-22 AC440
500 VAC	4PST-4NO	J7KCA-40 AC500
	4PST-3NO 1NC	J7KCA-31 AC500
	4PST-2NO 2NC	J7KCA-22 AC500
12 VDC	4PST-4NO	J7KCA-40 DC12
	4PST-3NO 1NC	J7KCA-31 DC12
	4PST-2NO 2NC	J7KCA-22 DC12
24 VDC	4PST-4NO	J7KCA-40 DC24
	4PST-3NO 1NC	J7KCA-31 DC24
	4PST-2NO 2NC	J7KCA-22 DC24
48 VDC	4PST-4NO	J7KCA-40 DC48
	4PST-3NO 1NC	J7KCA-31 DC48
	4PST-2NO 2NC	J7KCA-22 DC48
60 VDC	4PST-4NO	J7KCA-40 DC60
	4PST-3NO 1NC	J7KCA-31 DC60
	4PST-2NO 2NC	J7KCA-22 DC60
100 VDC	4PST-4NO	J7KCA-40 DC100
	4PST-3NO 1NC	J7KCA-31 DC100
	4PST-2NO 2NC	J7KCA-22 DC100

Coil rating	Contact configuration	Model
110 VDC	4PST-4NO	J7KCA-40 DC110
	4PST-3NO 1NC	J7KCA-31 DC110
	4PST-2NO 2NC	J7KCA-22 DC110
120 VDC	4PST-4NO	J7KCA-40 DC120
	4PST-3NO 1NC	J7KCA-31 DC120
	4PST-2NO 2NC	J7KCA-22 DC120
200 VDC	4PST-4NO	J7KCA-40 DC200
	4PST-3NO 1NC	J7KCA-31 DC200
	4PST-2NO 2NC	J7KCA-22 DC200
210 VDC	4PST-4NO	J7KCA-40 DC210
	4PST-3NO 1NC	J7KCA-31 DC210
	4PST-2NO 2NC	J7KCA-22 DC210
220 VDC	4PST-4NO	J7KCA-40 DC220
	4PST-3NO 1NC	J7KCA-31 DC220
	4PST-2NO 2NC	J7KCA-22 DC220

### Optional Unit (Order Separately)

#### Auxiliary contact unit

Number of poles	Contact configuration	Model
2	2PST-2NO	J73KC-AM-20
	2PST-1NO 1NC	J73KC-AM-11
	2PST-2NC	J73KC-AM-02
4	4PST-4NO	J73KC-AM-40
	4PST-3NO 1NC	J73KC-AM-31
	4PST-2NO 2NC	J73KC-AM-22
	4PST-1NO 3NC	J73KC-AM-13
	4PST-4NC	J73KC-AM-04

#### Coil surge absorption unit

Adopted Coil voltage type	LED indicator	Model
24-48 VAC	No	J76KC-RC-1
48-125 VAC		J76KC-RC-2
100-125 VAC		J76KC-RC-3
24-48 VAC	Yes	J76KC-RC-N-1
48-125 VAC		J76KC-RC-N-2

#### Insulation stop

Model	Minimum order (bag)
J77KC-K	1 (30 pcs./bag)

# J7KCA Series

## Ratings/Specifications

### Coil rating

#### AC operated

Displayed model	Rated voltage		Allowable voltage range		Must operate voltage	Must release voltage
	50 Hz	60 Hz	50 Hz	60 Hz		
AC 24	24 VAC	24-26 VAC	85 to 110%	21-27 VAC	85% max.	20% min.
AC 48	48 VAC	48-52 VAC		41-53 VAC		
AC 100	100 VAC	100-110 VAC		85-110 VAC		
AC 110	100-110 VAC	110-120 VAC		85-121 VAC		
AC 120	110-120 VAC	120-130 VAC		94-132 VAC		
AC 200	200 VAC	200-220 VAC		170-220 VAC		
AC 220	200-220 VAC	220-240 VAC		170-242 VAC		
AC 230	220-230 VAC	230 VAC		187-253 VAC		
AC 240	220-240 VAC	240-260 VAC		187-264 VAC		
AC 380	346-380 VAC	380-420 VAC		295-418 VAC		
AC 400	380-400 VAC	400-440 VAC		323-440 VAC		
AC 440	415-440 VAC	440-480 VAC		353-484 VAC		
AC 500	480-500 VAC	500-550 VAC		408-550 VAC		

#### DC operated

Displayed model	Rated voltage	Allowable voltage range		Must operate voltage	Must release voltage
DC 12	12 VDC	85 to 110%	11-14 VDC	85% max.	10% min.
DC 24	24 VDC		21-27 VDC		
DC 48	48 VDC		41-53 VDC		
DC 60	60 VDC		51-66 VDC		
DC 100	100 VDC		85-110 VDC		
DC 110	110 VDC		94-121 VDC		
DC 120	120 VDC		102-132 VDC		
DC 200	200 VDC		170-220 VDC		
DC 210	210 VDC		179-231 VDC		
DC 220	220 VDC		187-242 VDC		

### Coil characteristics (reference value)

#### AC operated

Frequency		50 Hz	60 Hz
Coil power consumption	Making (VA)	22 (200 V)	25 (220 V)
	Holding (VA)	4.5 (200 V)	4.5 (220 V)
Power loss (W)		1.2 (200 V)	1.3 (220 V)
Must operate voltage (V)		122 to 135	128 to 138
Must release voltage (V)		80 to 89	83 to 96
Operate time (ms)		17 to 26	
Release time (ms)		6 to 16	

- Note:**
1. Coil ratings: Characteristics for 200 VAC, 50 Hz / 200-220 VAC, 60 Hz
  2. Coil power consumption value is the same for a coil that is not rated 200 VAC.
  3. Indicated operate/release times for 200 VAC, 50 Hz.
  4. Closed and open voltages of 100 V coil (100 VAC, 50 Hz/100-110 VAC, 60 Hz) are approximately one half the values in the table above.
  5. Values in the table above are examples for 20°C cold condition.

#### DC operated

Coil power consumption	Making (W)	2.4 (24 V)
	Holding (W)	2.4 (24 V)
Time constant (ms)	Holding	20
Must operate voltage (V)		10 to 11
Must release voltage (V)		4 to 6
Operate time (ms)		34 to 60
Release time (ms)		5 to 10

- Note:**
1. Coil ratings: Characteristics for 24 VDC
  2. Coil power consumption value is the same for a coil that is not rated 24 VDC.
  3. Values in the table above are examples for 20°C cold condition.

## Characteristics

Auxiliary circuit ratings	Ratings based on IEC 60947-5-1/ JIS C 8201-5-1	Voltage range (V)		100-120 AC	200-240 AC	380-440 AC	500-600 AC	24 DC	48 DC	110 DC	220 DC		
		Rated operational current (A)	AC-15 (coil load)				DC-13 (coil load)						
			3	3	1	0.5	2	1	0.3	0.2			
			AC-12 (resistive load)				DC-12 (resistive load)						
		Contact closed and breaking current (A)	30	30	10	5	30	30	10	5			
	Conventional free air thermal current (rated carry current) (A)	10											
	Ratings based on UL 508	Rated carry current (A)		10				2.5					
		Voltage range		120 AC	240 AC	480 AC	600 AC	125 DC		250 DC			
		Contact closed current (A)		60	30	15	12	0.55		0.27			
		Breaking current (A)		6	3	1.5	1.2	0.55		0.27			
Rating code		A 600				Q 300							
Minimum operate voltage/current (reference value)		5 VDC, 3 mA											
Rated insulation voltage		690 VAC											
Rated impulse dielectric strength		6 kV											
Rated frequency		50/60 Hz											
Vibration resistance		Vibration: 10 to 55 Hz, acceleration: 15 m/s <sup>2</sup>											
Shock resistance		Shock value 50 m/s <sup>2</sup>											
Electrical/mechanical endurance	Switching frequency (times per hour)		1800										
	Mechanical (10,000 operations min.)		1000										
	Electrical (10,000 operations min.)	AC-15	220 V	50									
			440 V	50									
		AC-12	220 V	25									
			440 V	25									
		DC-13	220 V	15									
DC-12		220 V	50										
Contact resistance (reference value)		50 mΩ max. (1 mA at 6 VDC using the voltage drop method)											
Contact structure		Double-break											
Contact material		Ag alloy											
Linked contact		Available *											
Degree of protection		IP20 (IEC60529)											
Operating temperature		-10 to +55°C (however, daily average shall not exceed 35°C)											
Ambient storage temperature		-40 to +65°C (no condensation or icing)											
Relative humidity		45% to 85% RH (no condensation or icing)											
Altitude		2000 m max.											
Weight		160 g (J7KCA-□-AC)/190 g (J7KCA-□-DC)											
Applicable standards	Safety standard		EN 60947-5-1 (IEC 60947-5-1), UL 60947-4-1, CSA 22.2 No.60947-4-1, CCC GB/T 14048.5, UKCA										

\* A linked contact is a mechanism found mainly in auxiliary relays. (Applicable models: J73KCA-31, J73KCA-22)

With the combination of the auxiliary circuit of the main unit, welding the NO (or NC) contacts will result in a structure that secures a shock resistance voltage of 2.5 kV or more, or a contact interval of 0.5 mm or more, for the NC (or NO) contacts even if the excitation of the coil is released. No linked contact structure is created with the combined usage of the auxiliary contact unit (J73KC-AM).

# J7KCA Series

## Dimensions

(Unit: mm)

### Main unit

#### J7KCA

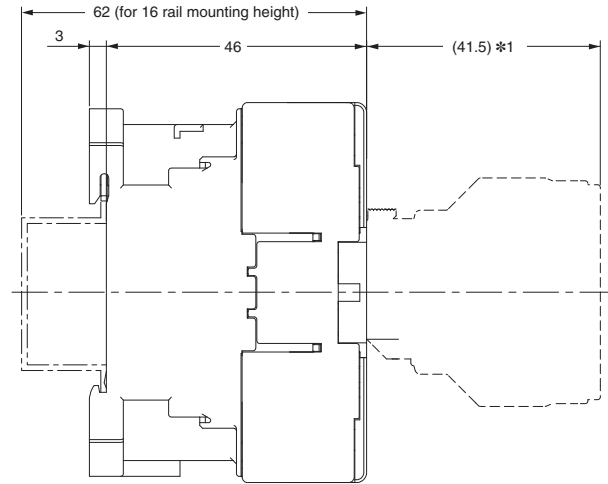
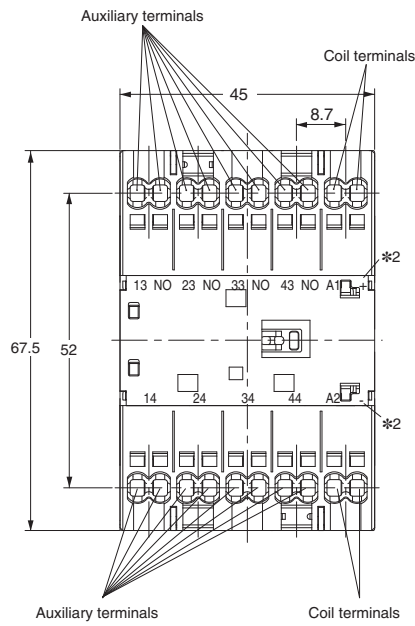

\*1. When auxiliary contact unit (J73KC) is mounted

Auxiliary contact	Contact configuration
4NO (4a)	
3NO1NC (3a1b)	
2NO2NC (2a2b)	

\*2. For DC operated

Option (Order Separately)

Auxiliary contact unit

J73KC

Ratings



Conventional free air thermal current (rated flowing current) [A]	Contact closed and Breaking current [A]	AC			DC			Minimum operate voltage/current
		Operating voltage [V]	Rated operational current [A]		Operating voltage [V]	Rated operational current [A]		
			Coil load (AC-15)	Resistive load (AC-12)		Coil load (DC-13)	Resistive load (DC-12)	
10	30	100 to 120 AC	3	6	24 DC	2	3	5 VDC, 3 mA
	30	200 to 240 AC	3	6	48 DC	1	2	
	10	380 to 440 AC	1	6	110 DC	0.3	1.5	
	5	500 to 600 AC	0.5	3	220 DC	0.2	0.5	

Connection diagram

Model	Contact configuration	Model	Contact configuration
J73KC-AM-40	4PST-4NO (4NO) 	J73KC-AM-04	4PST-4NC (4NC) 
J73KC-AM-31	4PST-3NO 1NC (3NO1NC) 	J73KC-AM-20	2PST-2NO (2NO) 
J73KC-AM-22	4PST-2NO 2NC (2NO2NC) 	J73KC-AM-11	2PST-1NO 1NC (1NO1NC) 
J73KC-AM-13	4PST-1NO 3NC (1NO3NC) 	J73KC-AM-02	2PST-2NC (2NC) 

Note: Refer to page 16 for linked contact relationships when combined with auxiliary relays.

Dimensions

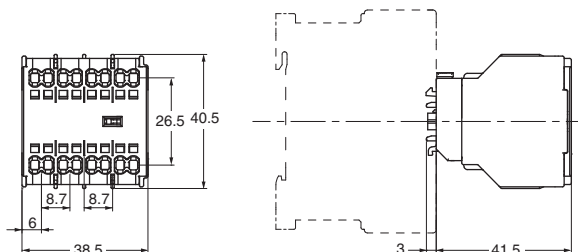

## Coil surge absorption unit

### Ratings

Model	Surge absorber	Varistor voltage	LED indicator	Applicable model		Control circuit voltage	
				AC operated	DC operated	AC	DC
J76KC-RC-1	Varistor	100 V	---	J7KCA-□-AC	---	24-48 VAC	Not required *
J76KC-RC-2		240 V				48-125 VAC	
J76KC-RC-3		470 V				100-250 VAC	
J76KC-RC-N-1		100 V	24-48 VAC				
J76KC-RC-N-2		240 V	48-125 VAC				

\* The DC operate (J7KCA-□-DC) has a varistor built into the main unit.

### Dimensions

#### J76KC-RC

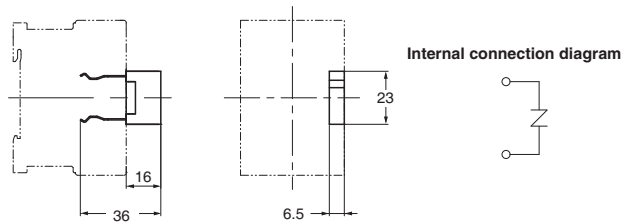

#### J76KC-RC-N

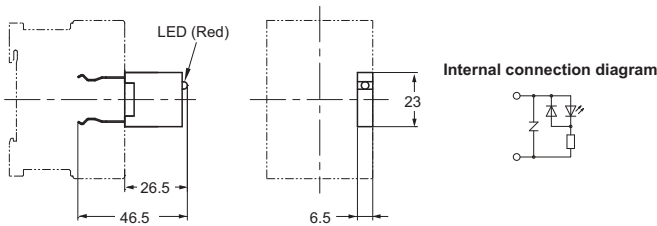

## Insulation stop

### J77KC-K

Guide for insertion into terminal (insertion) holes to stabilize holding of 1mm<sup>2</sup> or less stranded wire (direct insertion).

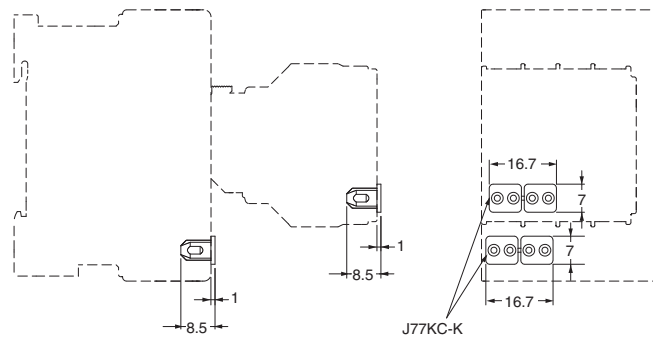



DIN Rails (Order Separately)

(Unit: mm)

Mounting Rail  
PFP-100N  
PFP-50N

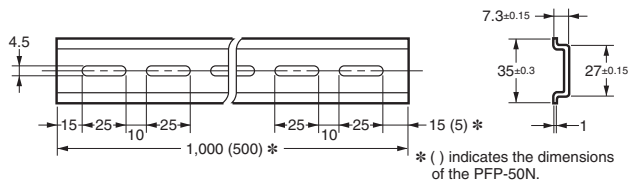
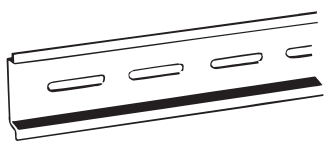

Model
PFP-100N
PFP-50N

Mounting Rail  
PFP-100N2

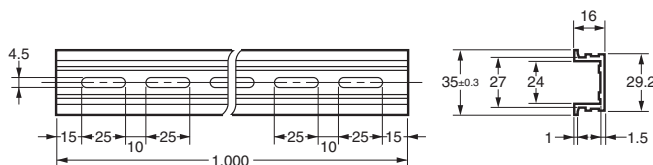
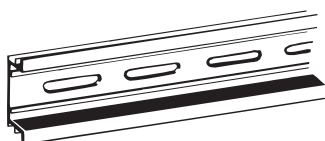

Model
PFP-100N2

End Plate  
PFP-M

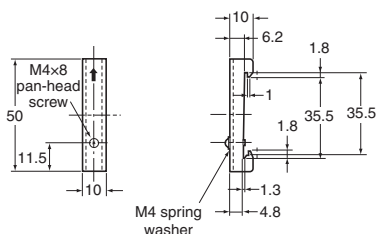
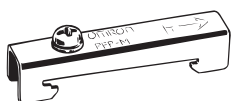

Model
PFP-M

Spacer  
PFP-S

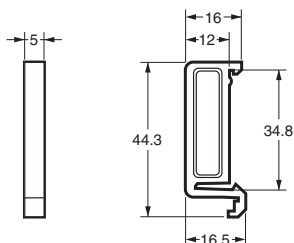
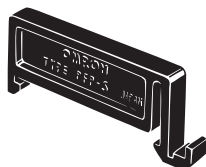

Model
PFP-S





Note: 1. Order the parts above in units of ten. The prices shown above are standard prices for one piece.  
2. Rails conform to DIN standards.

## Safety Precautions

### Warning Indications

 <b>CAUTION</b>	Indicates a potentially hazardous situation which, if not avoided, is likely to result in minor or moderate injury or property damage.
<b>Precautions for Safe Use</b>	Supplementary comments on what to do or avoid doing, to use the product safely.
<b>Precautions for Correct Use</b>	Supplementary comments on what to do or avoid doing to prevent failure to operate, malfunction, or undesirable effects on product performance.

### Meaning of Product Safety Symbols

	Used to warn of the risk of electric shock under specific conditions.
	Used to indicate prohibition when there is a risk of minor injury from electric shock or other source if the product is disassembled.
	Used for general prohibitions for which there is no specific symbol.
	Used for general mandatory action precautions for which there is no specified symbol.

### **CAUTION**

**Do not touch or approach the product while or immediately after power is supplied. Electric shock or burn injuries may occur.**



**Never disassemble, modify, or repair the product or touch any of the internal parts. Minor electric shock, fire, or malfunction may occasionally occur.**



**Do not use the product in an environment where flammable or explosive gas is present.**



**Relay life expectancy varies considerably with output load and switching conditions. Always consider the application conditions and use within the rated load and electrical life expectancy.**



### Precautions for Safe Use

- Do not use the product in any of the following locations.
  - Places subject to intense temperature changes
  - Places subject to high humidity or condensation
  - Places subject to intense vibration or shock
  - Places subject to considerable dust or corrosive gas, or directly exposed to sunlight
  - Places subject to splashing water, oil, or chemicals.
- Using the product in a place where there is an intense magnetic field may result in malfunctioning.
- Do not store or use in conditions that subject the product to an external load.
- The product has an internal permanent magnet. Do not bring other products that are susceptible to the effects of magnetism close to the product, or store together with the product.
- Securely mount the product on the rail.
- When mounting on a rail, use the end plate.
- Never drop the product or allow it to fall.
- Make sure that foreign matter does not collect or enter into the terminal (insertion) hole or release hole. Smoking or ignition, malfunctioning, or failure may occur.
- Do not use the product at less than the minimum applicable load.
- Never use at a load that exceeds the rated capacity.
- Select the coil specifications correctly.
- When using an AC current coil, malfunction or damage of the connected device may result due to the occurrence of a current surge.
  - Be sure to use a surge absorption Unit.
- For the coil, do not use a power supply that is also connected to a solenoid or similar device.
- Do not use an inverter power supply for the coil.
- Do not apply a voltage greater than the maximum allowable voltage to the coil.
- Use wire, ferrules, and tools with the required specifications. Strip the wires to the specified length, and use ferrules of the specified length. Insert all the way into the terminal (insertion) hole until the wire tip contacts the back.
  - (For details, refer to the information on pages 12 and 13.)
- If directly inserting wire, always use tin-plated strand wire.
- Do not insert multiple wires into one terminal (insertion) hole.
- Do not wire terminals that are not used.
- Make sure all wiring connections are correct before supplying power.
- Do not accidentally insert a wire into the release hole.
- Do not bend a wire past its natural bending radius or pull on it with excessive force.
- After inserting the tool into the release hole, do not pry with the tool.
- Do not insert the tool into the terminal (insertion) hole.
- Do not supply power while the tool is inserted into the release hole.
- Do not insert anything other than the specified tool into the release hole.
- When replacing the magnetic contactor/auxiliary relay, also replace the surge absorption unit at the same time.
- Wipe off any dirt from the product with a soft dry cloth. Never use thinners, benzene, alcohol, or any cleaners that contain these or other organic solvents. Deformation or discoloration may occur.
- When disposing of the product, follow local disposal procedures for industrial waste.

### Precautions for Correct Use

- Check the terminal polarity and wire correctly.
- If the power voltage fluctuates, ensure that enough voltage is applied to the coil to enable each contactor to fully operate.
- Avoid use in a location with many magnetic particles. Risk of failure.
- Follow the procedure in the datasheet to securely install the unit on the main unit.

## Mounting, removal and wiring (connection)

### How to mount on rail

Follow the procedures below to mount the product on the rail or remove it from the rail.

[Mounting]

- (1) Tilt the product about 10° with respect to the rail. Engage the hook at the power supply side and gently push the product down.
- (2) Press the product against the rail.
- (3) Lift the product up to engage the hook at the load side with the rail.
- (4) Gently jiggle the product to check that the load-side hook is engaged with the rail.

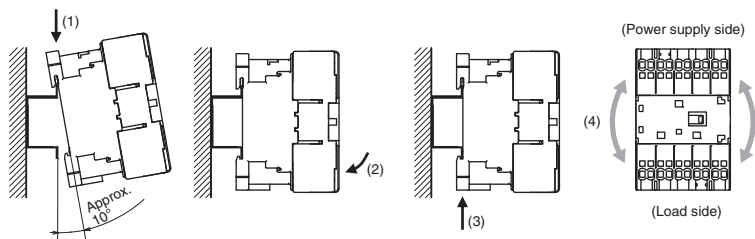

When mounting on a rail, use the end plate.

### Removing from rail

- (1) Hold the product at the top and bottom. Push it downward to release the lower hook.
- (2) Remove the product.

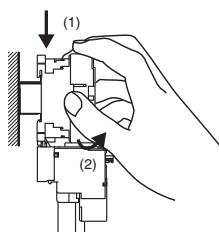

### Mounting angle

Appearance					
Mounting direction	Standard mounting	Inclined mounting	Sideways mounting	Coil downwards	Horizontal mounting
	---	30°	Coil upwards	Coil downwards	Terminals upwards
J7KCA-□-AC□	X	X	X	*1	X
J7KCA-□-DC□	X	X	*2	X	X

\*1. Allowable voltage fluctuation range is 90% to 110%.

\*2. Release (open) voltage is 5% to 70%.

### Installation interval

Mount with a separation of at least the dimension shown in the diagram.

When mounting products close together, comply with the standards below for the rated operational current and rated flowing current in the Characteristics table on pages 5. Increased temperature under some operating conditions (closely mounted products that are energized continuously or have a high switching frequency) may reduce the life of the coil.

Auxiliary circuit: If 7 A is exceeded, 7 A max.

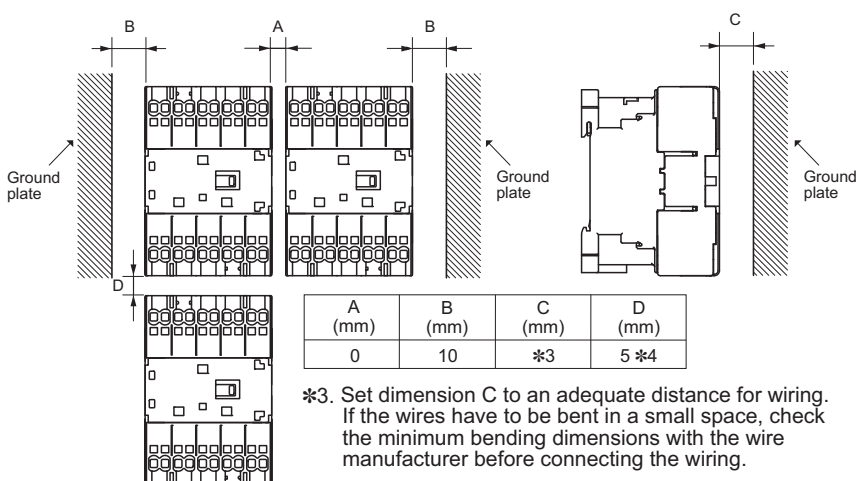

\*3. Set dimension C to an adequate distance for wiring. If the wires have to be bent in a small space, check the minimum bending dimensions with the wire manufacturer before connecting the wiring.

\*4. When installing vertically, use spacing of at least the D dimension to make installation/removal easier and to ensure sufficient insulation distance. When using connecting wires between the upper and lower contactor relays, also check with the wire manufacturer for the minimum bending dimensions of each wire before wiring to prevent excessive wire tension at the terminals.

## Wiring

### Wire with ferrule

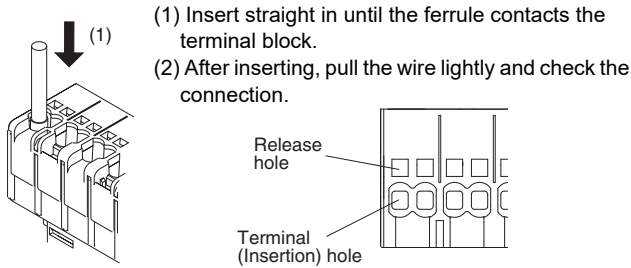

- (1) Insert straight in until the ferrule contacts the terminal block.
- (2) After inserting, pull the wire lightly and check the connection.

### Stranded wire (direct insertion)

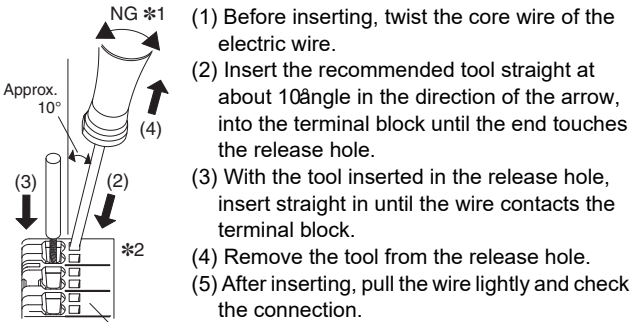

- (1) Before inserting, twist the core wire of the electric wire.
- (2) Insert the recommended tool straight at about 10° angle in the direction of the arrow, into the terminal block until the end touches the release hole.
- (3) With the tool inserted in the release hole, insert straight in until the wire contacts the terminal block.
- (4) Remove the tool from the release hole.
- (5) After inserting, pull the wire lightly and check the connection.

- \* When using an insulation stop After inserting the insulation stop into the terminal (insertion) hole all the way to the base, perform steps (1) to (5). The insulation stop will insert easily if you insert at a slight angle to the terminal (insertion) hole and twist as you press it in.
- \*1. Do not prying by the tool.
- \*2. If the terminal cover comes off because you pried with the tool, do not reuse it.

## Removing wire

### Common for electric wires with ferrules and stranded wires (direct insertion)

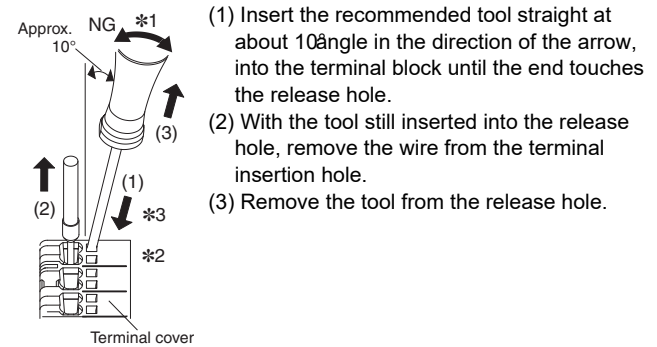

- (1) Insert the recommended tool straight at about 10° angle in the direction of the arrow, into the terminal block until the end touches the release hole.
- (2) With the tool still inserted into the release hole, remove the wire from the terminal insertion hole.
- (3) Remove the tool from the release hole.

- \*1. Do not prying by the tool.
- \*2. If the terminal cover comes off because you pried with the tool, do not reuse it.
- \*3. The inside of the release hole is electrically live. Electric shock may result. Do not use a screwdriver with a metal handle. Do not touch the metal part of the tool.

## Connection method and application size of the electric wire

- If directly inserting wire, always use tin-plated strand wire.
- Crimp the ferrule for stranded wires that are not tin plated.
- Solid wire and bar terminals cannot be used.

### Applicable wire sizes

Applicable wire		Ferrule			Stranded wire (direct insertion) *4
		Size (mm <sup>2</sup> )	With an insulation sleeve (L = 8 mm, 10 mm)	Without an insulation sleeve (L = 10 mm)	
(mm <sup>2</sup> )	(AWG)			Auxiliary/control circuit	Auxiliary/control circuit
0.5	20	0.5	⊙	⊙	⊙ (*3)
0.75	18	0.75	⊙	⊙	⊙ (*3)
1		1	⊙	⊙	
1.25	16	1.5	⊙	⊙	⊙
1.5					
2	14	2 (*2)	⊙	⊙	---
		2.5	⊙	⊙	
2.5			---	⊙	---

⊙: 2 wires allowed (simultaneous connection for crossover wiring terminals),  
 ○: 1 wire allowed, -: out of specification

- \*1. For compliance with UL or CSA standards, you must use wires of the following sizes.  
 Auxiliary circuit: 16 AWG to 14 AWG
- \*2. Connection is only possible using 2 mm<sup>2</sup> FE-2.08-8N-YE ferrules with insulation sleeves manufactured by Wago.
- \*3. Use insulation stops.  
 Insulation stops cannot be used with ferrules.  
 Do not use insulation stops in empty terminals.
- \*4. Insulation stripping length for stranded wires (direct insertion) is as follows.  
 0.5 mm<sup>2</sup> to 1.0 mm<sup>2</sup> (20AWG to 18AWG) : 12 mm ± 1 mm  
 1.25 mm<sup>2</sup> (16AWG) : 11 mm ± 1 mm  
 When using ferrules, refer to the table of recommended ferrules.

## Recommended Ferrules and Crimp Tools

### Recommended ferrules

Applicable wire		Ferrule conductor length (mm)	Recommended ferrules							
			With an insulation sleeve				Without an insulation sleeve			
(mm <sup>2</sup> )	(AWG)		Insulation stripping length (mm)	Phoenix Contact	Weidmuller	Wago	Insulation stripping length (mm)	Phoenix Contact	Weidmuller	Wago
0.5	20	8	10	Al 0,5-8	H0.5/14	216-201	---	---	---	---
		10	12	Al 0,5-10	H0.5/16	216-241	10	A 0,5-10	H0.5/10	F-0.5-10
0.75	18	8	10	Al 0,75-8	H0.75/14	216-202	---	---	---	---
		10	12	Al 0,75-10	H0.75/16	216-242	10	A 0,75-10	H0.75/10	F-0.75-10
1/1.25	18/17	8	10	Al 1-8	H1.0/14	216-203	---	---	---	---
		10	12	Al 1-10	H1.0/16	216-243	10	A 1-10	H1.0/10	F-1.0-10
1.25/1.5	17/16	8	10	Al 1,5-8	H1.5/14	216-204	---	---	---	---
		10	12	Al 1,5-10	H1.5/16	216-244	10	A 1,5-10	H1.5/10	F-1.5-10
2	14	8	10	Al 2,5-8	H2.5/15D	216-205	---	---	---	---
		10	12	Al 2,5-10	---	216-206				
2.5	14	10	12	---	---	---	10	---	H2.5/10	F-2.5-10
		12	14	---	---	---	---	---	---	---
Recommended crimp tool				CRIMPFOX 6 CRIMPFOX 6T-F CRIMPFOX 10S	PZ6 roto	Variocrimp4		CRIMPFOX 6 CRIMPFOX 6T-F CRIMPFOX 10S	PZ6 roto	Variocrimp4

\* Make sure that the outer diameter of the wire coating is smaller than the inner diameter of the insulation sleeve of the recommended ferrule.

### Ferrule processing dimensions

Dimension (after processing)	Auxiliary/control circuit	
	Minimum	Maximum
L [mm]	0	0.5
D [mm]	Less than 2.5	
Wire size	[mm <sup>2</sup> ]	0.5
	[AWG]	20
		1.5
		16

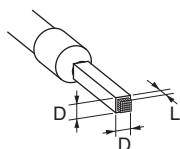

### Recommended flat-bladed screwdriver (Recommended tool)

Use a flat-blade screwdriver to connect and remove wires. Use the flat-blade screwdriver shown in the table below. The following table shows manufacturers and models as of 2018/Dec.

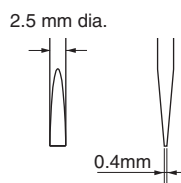

Model	Manufacturer
ESD 0,40 × 2,5	Wera
SZS 0,4 × 2,5 SZF 0-0,4 × 2,5 *	Phoenix Contact
0,4 × 2,5 × 75 302	Wiha
AEF.2,5 × 75	Facom
210-719	Wago
SDIS 0,4 × 2,5 × 75	Weidmuller
9900 (-2,5 × 75)	Vessel

\* OMRON's exclusive purchase model XW4Z-00B is available to order as SZF 0-0,4×2,5 (manufactured by Phoenix Contact).

### Voltage fluctuation range and voltage drop in control circuit

- AC-operated (J7KCA-□-AC□)

Must operate voltage: 85% to 110% of rated voltage

However, this is the rated voltage for making. It can be used with no concern about contact welding even if the voltage drops to 75% of the rated voltage when the main contacts are closed.

- DC-operated (J7KCA-□-DC□)

Must operate voltage: 85% to 110% of rated voltage (55°C ambient temperature), 80 to 110% (40°C ambient temperature)

However, this is the rated voltage for making. It can be used with no concern about contact welding even if the voltage drops to 75% of the rated voltage when the main contacts are closed.

## Connection to peripherals

(1) AC-operated

The control coil of AC-operated does not contain a built-in surge absorber. Use an optional coil surge absorption unit if required.

(2) DC-operated

The control coil of DC-operated contains a built-in surge absorber (varistor). Therefore, it is not necessary to connect an external surge absorption circuit in a normal sequence circuit. (See Table 1)

Connect the control coil terminals and various DC output devices as shown in Table 2.

Note that the control coil terminals have A1 (plus) and A2 (minus) polarities.

**Table 1. Coil voltages and varistor voltages of DC-operated**

Coil voltage [V]	Varistor voltage [V]
12	39
24	
48	
60	100
100	
110	
120	
200	
210	470
220	

**Table 2. Connection of control coil terminals and peripherals for DC-operated**

Device output form	Without protective diode		With built-in protective diode	
	Connection method			
Example of device	Various DC output models	NPN output photoelectric switch, proximity switch, etc.	PNP output photoelectric switch, proximity switch, etc.	Programmable controller, etc.
Precautions	Use an output transistor with a dielectric strength of at least (coil surge voltage + output power supply voltage).	---	---	The release time is extended due to the built-in protective diode.

## Coil surge absorption characteristics

AC operated	Application	Coil surge absorption characteristics (200 VAC coil)
Without surge absorption unit	Due to the sudden current change when the coil turns off, a steep surge voltage is generated from the coil due to the coil inductance, and this becomes noise in the peripheral electronic equipment that may cause a malfunction or circuit damage.	J7KCA-□-AC  (0.1 ms/div, 1 kV/div)
Varistor	When the surge voltage reaches or exceeds a certain level, current flows through the varistor connected in parallel with the coil, which has the effect of controlling the peak wave of the surge voltage. The varistor can be used in AC or DC circuits. The suppression surge voltage is approximately the varistor voltage.	J7KCA-□-AC+J7K6C-RC-3  (2 ms/div, 200 V/div)

DC operated	Application	Coil surge absorption characteristics (24 V DC coil)
Varistor (Built into main unit)	When the surge voltage reaches or exceeds a certain level, current flows through the varistor connected in parallel with the coil, which has the effect of controlling the peak wave of the surge voltage.	J7KCA-□-DC (Built into varistor)  (0.1 ms/div, 1 kV/div)

### Mounting or removing the auxiliary contact unit

- To mount the unit, tilt it with respect to direction (1) and press it against the main unit, engage hook 1 of the unit with the mounting groove, rotate it in direction (2), and check that hook 2 is securely engaged with the main unit.

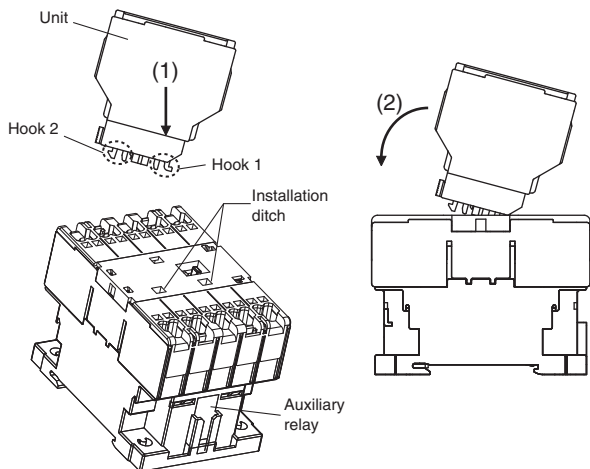

Diagram 1. Mounting method

- To remove the unit, press in hook 2 of the unit between your fingers and rotate it in direction (3) to unlock and remove the unit.

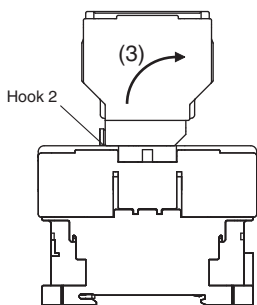

Diagram 2. Removal method

### Mounting space

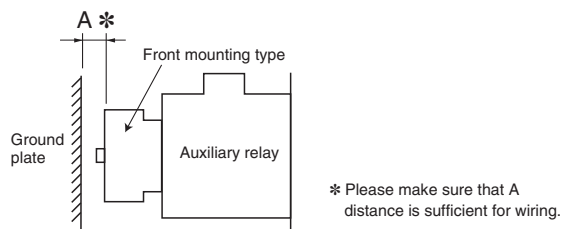
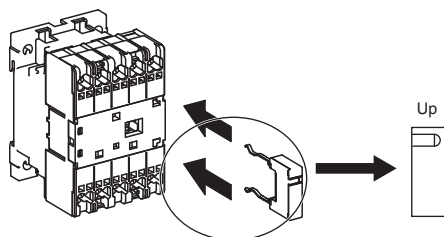

Diagram 3. Mounting space

### Mounting the coil surge absorption unit

Push the unit into the mounting holes in the auxiliary relay. The unit has a defined vertical orientation. Do not mount it upside down.



### Electrical detection

Electricity can be detected by inserting a detector in the release hole.

When inserting a detector, insert it gently while checking for electrical signals. The wire may pull out if the detector is fully inserted.

After detection is complete, immediately pull out the detector and check that the wire is still firmly connected.

## Linked contact mechanisms

With the combination of the auxiliary circuit of the main unit, welding the NO (or NC) contacts will result in a structure that secures a shock resistance voltage of 2.5 kV or more, or a contact interval of 0.5 mm or more, for the NC (or NO) contacts even if the excitation of the coil is released.

### Example figure of linked contact mechanism

Impulse withstand voltage: 2.5 kV min. or contact separation (a): 0.5 mm min.

[Linked contact IEC 60947-5-1]

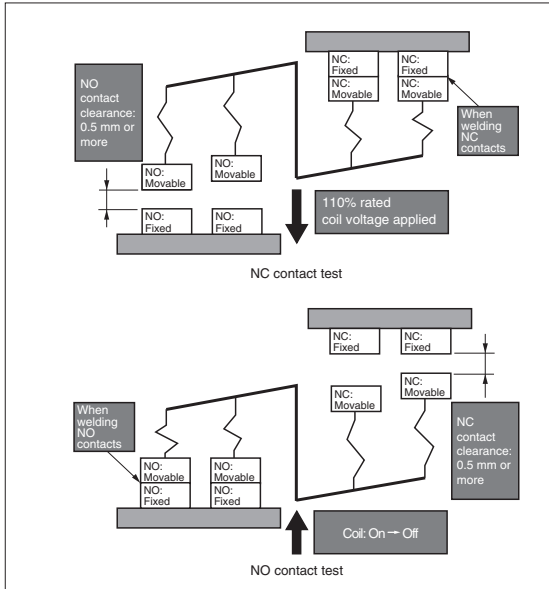

### Linked contact relationship when using auxiliary relays only

Auxiliary relay	Linked contact relationship
J7KCA-40 (Auxiliary contact 4PST-4NO)	There is no linked contact mechanism because the auxiliary contact only has NO contacts.
J7KCA-31 (Auxiliary contact 4PST-3NO 1NC) J7KCA-22 (Auxiliary contact 4PST-2NO 2NC)	The NC auxiliary contact acts as the linked contact mechanism for the NO auxiliary contact. (The NO auxiliary contact also acts as the linked contact mechanism for the NC auxiliary contact.)

### Linked contact relationship when using auxiliary relays together with auxiliary contact units

Auxiliary relay	Linked contact relationship
J7KCA-40 (Auxiliary contact 4PST-4NO) J7KCA-31 (Auxiliary contact 4PST-3NO 1NC) J7KCA-22 (Auxiliary contact 4PST-2NO 2NC)	There is no linked contact mechanism for combinations with an auxiliary contact unit (J73KC-AM).

## Recommended replacement period

Magnetic contactors and switches have a wear life according to the number of switching cycles of their main contacts and mechanical parts. The coil wiring and electronic parts in the electronic unit have a service life resulting from deterioration due to the operating environment and conditions.

You are recommended to replace magnetic contactors and switches after the rated number of switching cycles specified in the catalog, or 10 years after the date of manufacture according to the standard conditions of operation described in the "Survey on Low-voltage Equipment Update Recommendation Times" report prepared by the Japan Electrical Manufacturers' Association (JEMA).



# Terms and Conditions Agreement

## **Read and understand this catalog.**

Please read and understand this catalog before purchasing the products. Please consult your OMRON representative if you have any questions or comments.

## **Warranties.**

- (a) Exclusive Warranty. Omron's exclusive warranty is that the Products will be free from defects in materials and workmanship for a period of twelve months from the date of sale by Omron (or such other period expressed in writing by Omron). Omron disclaims all other warranties, express or implied.
- (b) Limitations. OMRON MAKES NO WARRANTY OR REPRESENTATION, EXPRESS OR IMPLIED, ABOUT NON-INFRINGEMENT, MERCHANTABILITY OR FITNESS FOR A PARTICULAR PURPOSE OF THE PRODUCTS. BUYER ACKNOWLEDGES THAT IT ALONE HAS DETERMINED THAT THE PRODUCTS WILL SUITABLY MEET THE REQUIREMENTS OF THEIR INTENDED USE.

Omron further disclaims all warranties and responsibility of any type for claims or expenses based on infringement by the Products or otherwise of any intellectual property right. (c) Buyer Remedy. Omron's sole obligation hereunder shall be, at Omron's election, to (i) replace (in the form originally shipped with Buyer responsible for labor charges for removal or replacement thereof) the non-complying Product, (ii) repair the non-complying Product, or (iii) repay or credit Buyer an amount equal to the purchase price of the non-complying Product; provided that in no event shall Omron be responsible for warranty, repair, indemnity or any other claims or expenses regarding the Products unless Omron's analysis confirms that the Products were properly handled, stored, installed and maintained and not subject to contamination, abuse, misuse or inappropriate modification. Return of any Products by Buyer must be approved in writing by Omron before shipment. Omron Companies shall not be liable for the suitability or unsuitability or the results from the use of Products in combination with any electrical or electronic components, circuits, system assemblies or any other materials or substances or environments. Any advice, recommendations or information given orally or in writing, are not to be construed as an amendment or addition to the above warranty.

See <http://www.omron.com/global/> or contact your Omron representative for published information.

## **Limitation on Liability: Etc.**

OMRON COMPANIES SHALL NOT BE LIABLE FOR SPECIAL, INDIRECT, INCIDENTAL, OR CONSEQUENTIAL DAMAGES, LOSS OF PROFITS OR PRODUCTION OR COMMERCIAL LOSS IN ANY WAY CONNECTED WITH THE PRODUCTS, WHETHER SUCH CLAIM IS BASED IN CONTRACT, WARRANTY, NEGLIGENCE OR STRICT LIABILITY.

Further, in no event shall liability of Omron Companies exceed the individual price of the Product on which liability is asserted.

## **Suitability of Use.**

Omron Companies shall not be responsible for conformity with any standards, codes or regulations which apply to the combination of the Product in the Buyer's application or use of the Product. At Buyer's request, Omron will provide applicable third party certification documents identifying ratings and limitations of use which apply to the Product. This information by itself is not sufficient for a complete determination of the suitability of the Product in combination with the end product, machine, system, or other application or use. Buyer shall be solely responsible for determining appropriateness of the particular Product with respect to Buyer's application, product or system. Buyer shall take application responsibility in all cases.

NEVER USE THE PRODUCT FOR AN APPLICATION INVOLVING SERIOUS RISK TO LIFE OR PROPERTY OR IN LARGE QUANTITIES WITHOUT ENSURING THAT THE SYSTEM AS A WHOLE HAS BEEN DESIGNED TO ADDRESS THE RISKS, AND THAT THE OMRON PRODUCT(S) IS PROPERLY RATED AND INSTALLED FOR THE INTENDED USE WITHIN THE OVERALL EQUIPMENT OR SYSTEM.

## **Programmable Products.**

Omron Companies shall not be responsible for the user's programming of a programmable Product, or any consequence thereof.

## **Performance Data.**

Data presented in Omron Company websites, catalogs and other materials is provided as a guide for the user in determining suitability and does not constitute a warranty. It may represent the result of Omron's test conditions, and the user must correlate it to actual application requirements. Actual performance is subject to the Omron's Warranty and Limitations of Liability.

## **Change in Specifications.**

Product specifications and accessories may be changed at any time based on improvements and other reasons. It is our practice to change part numbers when published ratings or features are changed, or when significant construction changes are made. However, some specifications of the Product may be changed without any notice. When in doubt, special part numbers may be assigned to fix or establish key specifications for your application. Please consult with your Omron's representative at any time to confirm actual specifications of purchased Product.

## **Errors and Omissions.**

Information presented by Omron Companies has been checked and is believed to be accurate; however, no responsibility is assumed for clerical, typographical or proofreading errors or omissions.

**Note: Do not use this document to operate the Unit.**

**OMRON Corporation Industrial Automation Company**

**Kyoto, JAPAN**

**Contact : [www.ia.omron.com](http://www.ia.omron.com)**

**Regional Headquarters**

**OMRON EUROPE B.V.**

Wegalaan 67-69, 2132 JD Hoofddorp  
The Netherlands  
Tel: (31) 2356-81-300 Fax: (31) 2356-81-388

**OMRON ELECTRONICS LLC**

2895 Greenspoint Parkway, Suite 200  
Hoffman Estates, IL 60169 U.S.A.  
Tel: (1) 847-843-7900 Fax: (1) 847-843-7787

**OMRON ASIA PACIFIC PTE. LTD.**

438B Alexandra Road, #08-01/02 Alexandra  
Technopark, Singapore 119968  
Tel: (65) 6835-3011 Fax: (65) 6835-3011

**OMRON (CHINA) CO., LTD.**

Room 2211, Bank of China Tower,  
200 Yin Cheng Zhong Road,  
PuDong New Area, Shanghai, 200120, China  
Tel: (86) 21-6023-0333 Fax: (86) 21-5037-2388

**Authorized Distributor:**

©OMRON Corporation 2019-2024 All Rights Reserved.  
In the interest of product improvement,  
specifications are subject to change without notice.

**CSM\_6\_1**

**Cat. No. J232-E1-06 0524 (0919)**