

IoT Flow Sensors/IoT Pressure Sensors

E8FC/E8PC Series

Additional "temperature monitoring" feature that allows you to detect cooling and hydraulic pressure abnormalities quickly

Flow Sensor
E8FC

ℓ/min °C

Pressure Sensor
E8PC

MPa °C



Water
and
oil

"Temperature" can also be monitored in the same allowing quicker detection of signs of abnormalities

For detecting signs of hydraulic pressure abnormalities

Pressure + Temp.

IoT Pressure Sensor

E8PC

For detecting signs of cooling abnormalities

Flow rate + Temp.

IoT Flow Sensor

E8FC

Signs of cooling abnormalities detected with "temperature"

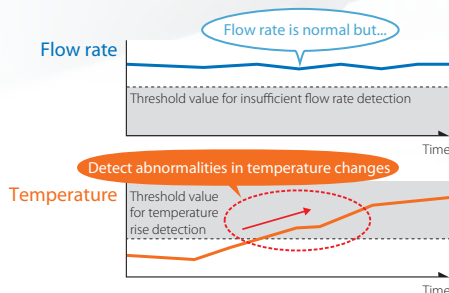

Even if the cooling water flow rate satisfies the conditions, if the water temperature is too high and it is not sufficiently cooled, manufacturing defects will occur. It is crucial to be able to monitor flow rate and temperature in the same position at the same time.

Signs of hydraulic pressure drops detected with "temperature"

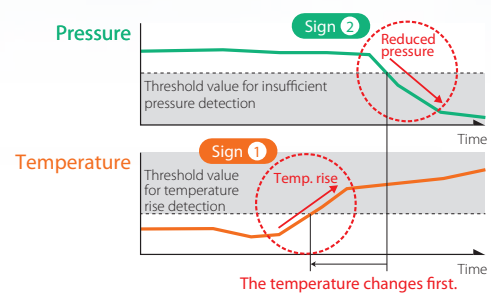

Signs of hydraulic pressure drops are shown by rises in temperature. It is crucial to be able to monitor pressure and temperature in the same position at the same time.

position,
than conventional methods

flexible

Water and oil NEW

The new E8FC Flow Sensor can also be used for water-soluble coolant and water-insoluble oil. Both the E8FC and E8PC Sensors can be integrated into a wide range of equipment.



Water



Water-soluble coolant

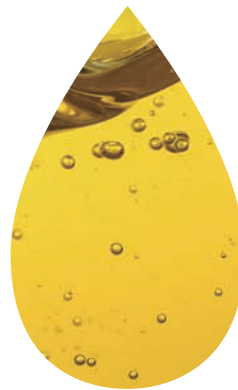

Water-insoluble oil



Easy retrofit into existing and overseas equipment

E8FC

Scaling function NEW

Flow rate values can be scaled according to piping conditions and fluid types.

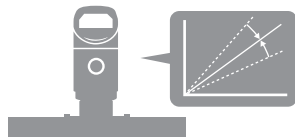

E8FC E8PC

Simultaneous analog output of flow rate or pressure + temperature NEW

Two types of measured values can be output as analog currents at the same time. This facilitates connection to existing equipment which has only analog input devices.

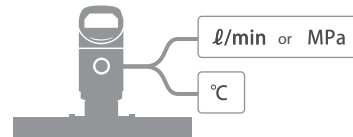

E8FC E8PC

Peak/Bottom Hold function NEW

Understanding of the flow rate or pressure values that can lead to cooling or pressure abnormalities is helpful for maintenance of existing equipment.

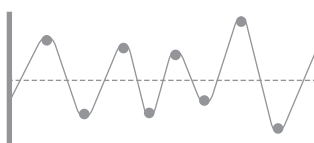

E8FC E8PC

NPN/PNP selection NEW

A single sensor can be used for both NPN and PNP outputs, helping you reduce maintenance stock. This also makes it easy to use for overseas machines.

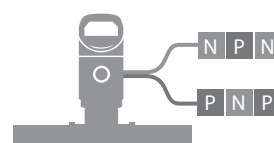

IoT Flow Sensor

E8FC



Prevents sudden stops and molding defects

due to cooling abnormalities

case 01 **Welding machine**

Problems

[Deformed welding tips and overheated transformers due to cooling performance degradation]

- If the cooling water temperature rises, the welding tip or welding transformer cannot be sufficiently cooled.
- If the welding tip gets overheated and deformed, welding defects occur.
- The welding transformer gets overheated, and the equipment suddenly stops.
- You cannot detect a cooling water temperature rise by monitoring the flow rate alone.

Solution from OMRON

Temp. You can detect signs even before welding tip deformation or sudden stops occur

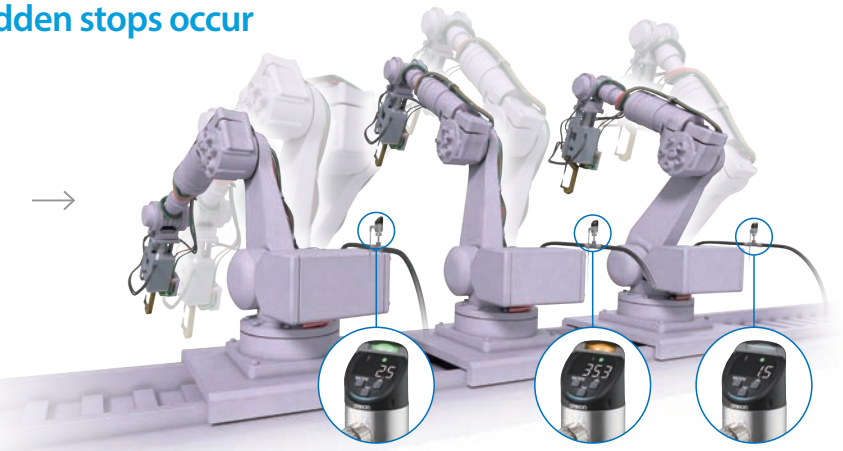
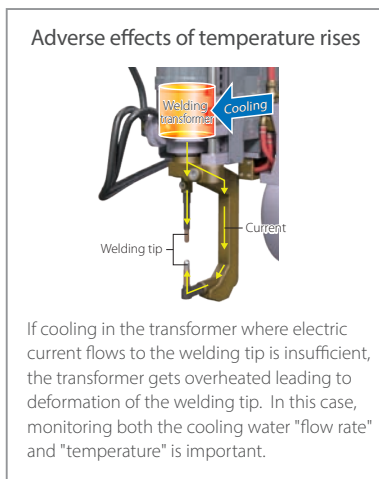

You can simultaneously monitor whether the cooling water for the welder transformer has both a "optimum flow rate" and "optimum temperature", for continuous monitoring of the cooling water performance state. This enables to detect abnormality signs of equipment.

LED display for cooling performance

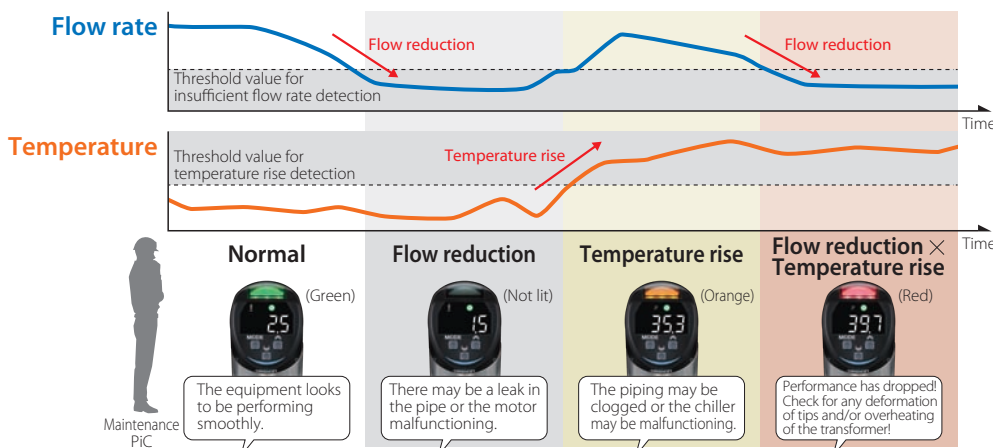

With the IoT Flow Sensor E8FC, you can simultaneously monitor the flow rate and temperature in the same position. Set these threshold levels, then the LED display indicates the statuses either individually or both the flow rate and temperature. You can "visualize" the status of the equipment, etc., with signs of abnormalities.



case 02 Molding machine

Problems

[Molding defects due to cooling performance degradation]

- Even if the amount of cooling water is adequate, a rise in water temperature leads to a drop in cooling performance.
- If the cooling performance declines, the processed part on the mold cannot be adequately cooled, resulting in deformation, voids, or other molding defects.
- You cannot detect a cooling water temperature rise by monitoring the flow rate alone.

Solution from OMRON



You can detect signs of cooling performance degradation even before occurrence of molding defects.

Monitor the "flow rate" and "temperature changes" in the same position, and quantify the optimum ranges for flow rate and temperature. You can detect signs of cooling performance degradation without relying on the experience or skills of maintenance personnel.

In addition, by mounting sensors on multiple pipes, you can quickly tell from the sensor LEDs what abnormality has occurred, in which pipe.

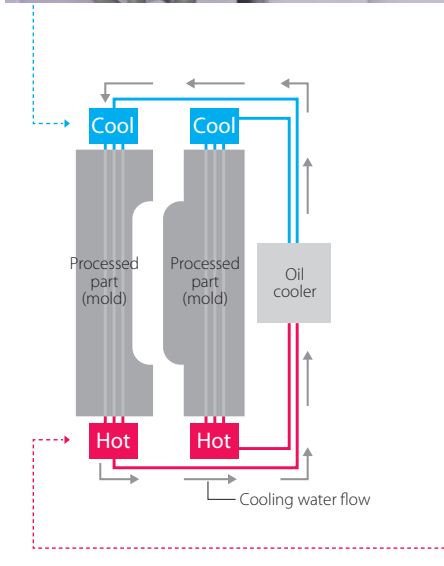
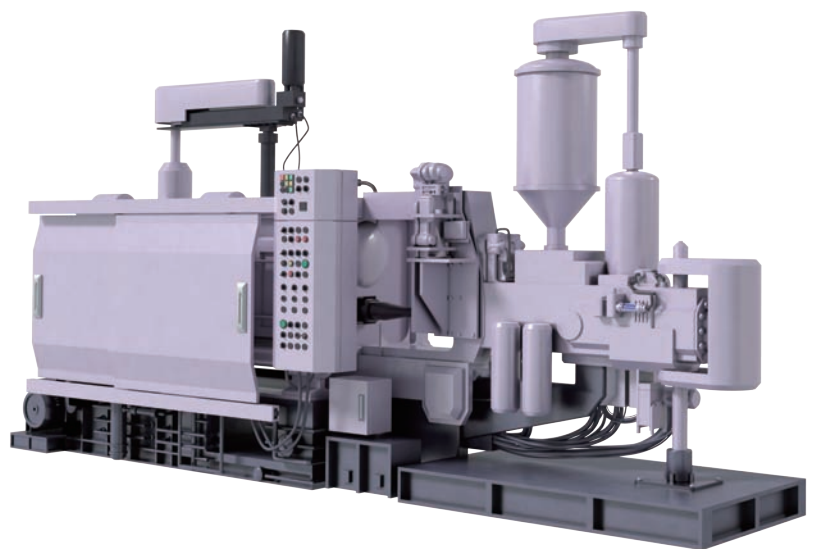

IoT Flow
Sensor

E8FC



Prevents insufficient strength
of parts
due to cooling abnormalities

case
03

Carburizing furnace

Problems

[Parts strength defects due to cooling performance degradation]

- The requirement for the parts strength is stricter than before, which makes the stable cooling performance of the carburizing furnace more important.
- To meet this requirement, not only the currently measured cooling water flow rate but also the temperature must be maintained to be constant.
- Additional installation of a thermometer incurs high plumbing costs.



You can optimize cooling performance by monitoring flow rate and temperature to enhance strength of parts

You can simultaneously monitor cooling water temperature and flow rate to maintain and control the ideal cooling performance. This ensures consistent finish and raises the strength level of parts. Machines can be developed to enhance strength by leveraging cooling performance data.

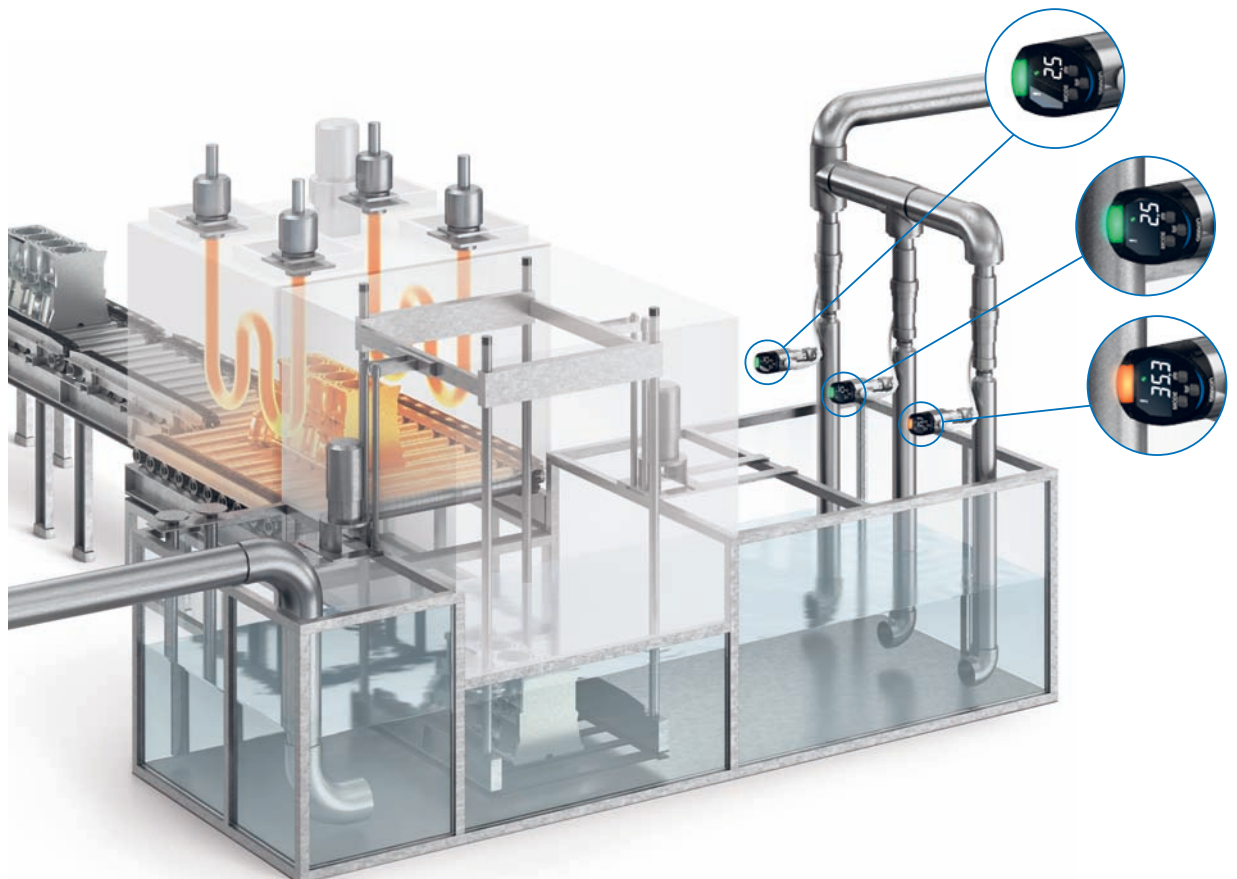

Solution from OMRON



Multi-sensing technology

Flow rate

Uses the "Thermal flow rate measurement algorithm". The sensor calculates first the flow velocity by measuring how fast the fluid cools the heated temperature measuring element Ta, and then the flow rate based on the pipe diameter.

Temp.

The temperature measuring element Tb directly measures fluid temperature.

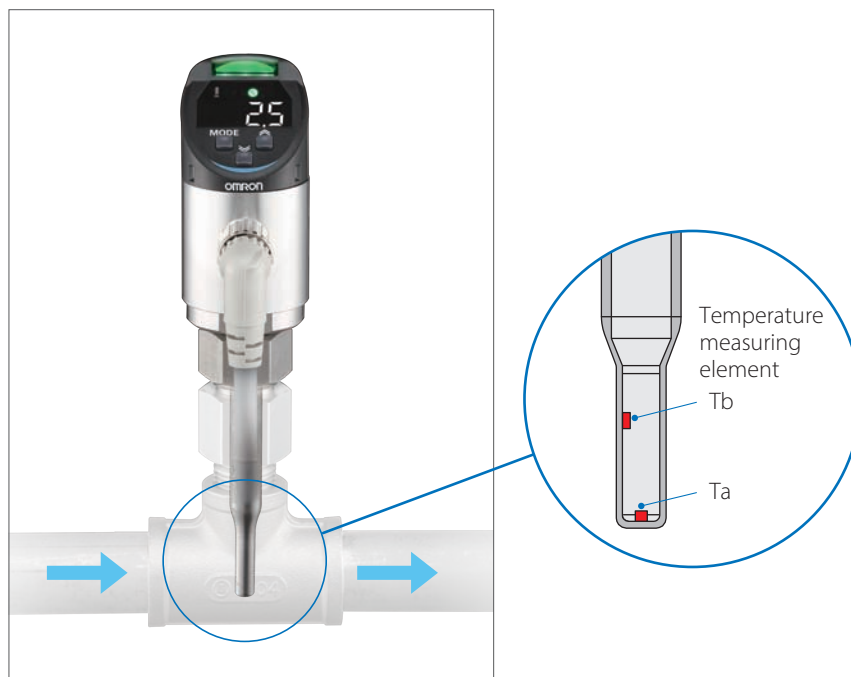

Ta: Pulse current is applied to the temperature measuring element Ta at the bottom.

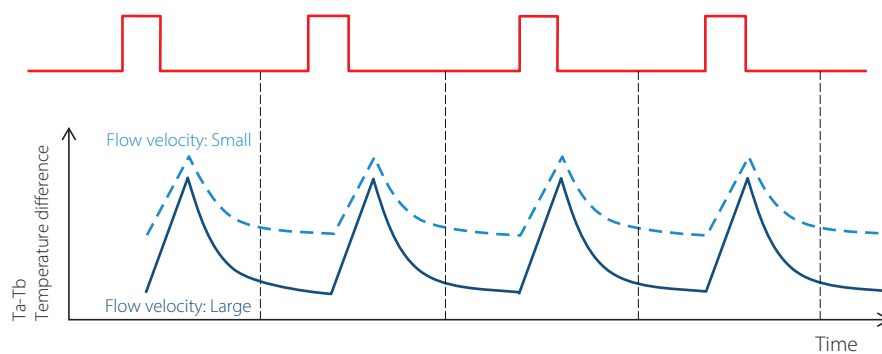

IoT Pressure Sensor

E8PC



Prevents press defects and processing defects due to hydraulic pressure abnormalities

case 04

Pressing machine

Problems

[Press quality defects due to rises in hydraulic oil temperature]

- Rising temperatures reduce the viscosity of the hydraulic oil.
- Hydraulic pressure reduction leads to inconsistent press quality.
- You cannot detect a hydraulic oil temperature rise by pressure monitoring oil alone.

Solution from OMRON



You can use signs of press pressure reduction to prevent the occurrence of product defects

With temperature monitoring, you can detect signs of abnormalities that can cause reductions in hydraulic oil viscosity. With simultaneous monitoring of temperature and pressure in the same position, you can quantify the optimum ranges for temperature and oil pressure without relying on the experience or skills of maintenance personnel.

Steps until occurrence of manufacturing defects

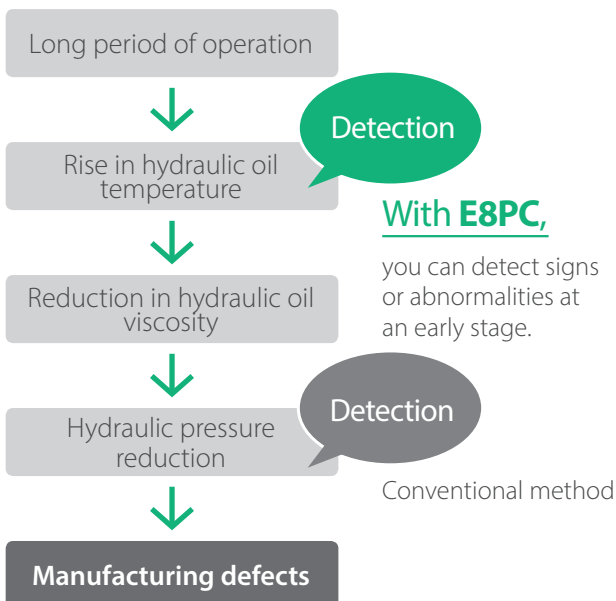

case 05 Machining center

Problems

[Tool gripping force declines due to hydraulic oil leak]

- Hydraulic oil temperature rises with repeated tool changes.
- Pipe packing deteriorates, resulting in hydraulic oil leak.
- Oil pressure reduction causes reduction in processing quality.
- The hydraulic pressure system is divided into multiple sections, so finding degraded packing locations takes time.

Solution from OMRON



You can use a rise in hydraulic oil temperature to detect signs of hydraulic oil leak

You can monitor hydraulic oil temperature changes to understand how much of a rise in temperature will have an effect on packing degradation. By mounting sensors on multiple pipes, you can quickly tell from the sensor LED displays what abnormality has occurred, in which pipe.

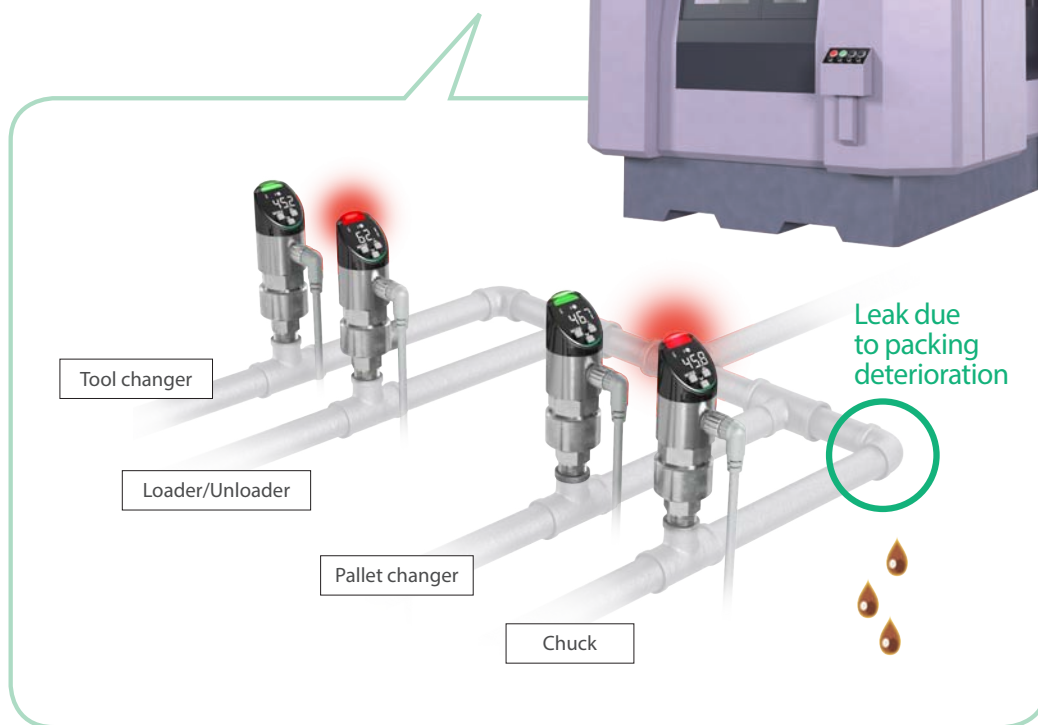



Detects signs of change in sealant temperature leading to incorrect dispensed amount

case 06 Sealant dispenser

Problems

[Bonding defects due to rises in sealant temperature]

- The dispensed amount varies even at the same dispensing pressure depending on changes in the sealant viscosity due to temperature variations.
- Both the dispensing pressure and temperature need to be controlled to dispense the same amount.
- There is no space to install two sensors.

Solution from OMRON



You can use signs of change in dispensing pressure to prevent the occurrence of parts defects

With temperature monitoring, you can detect signs of abnormalities that can cause reductions in sealant viscosity. With simultaneous monitoring of temperature and pressure, you can quantify the optimum ranges for temperature and dispensing pressure without relying on the experience or skills of maintenance personnel.

Steps until occurrence of manufacturing defects

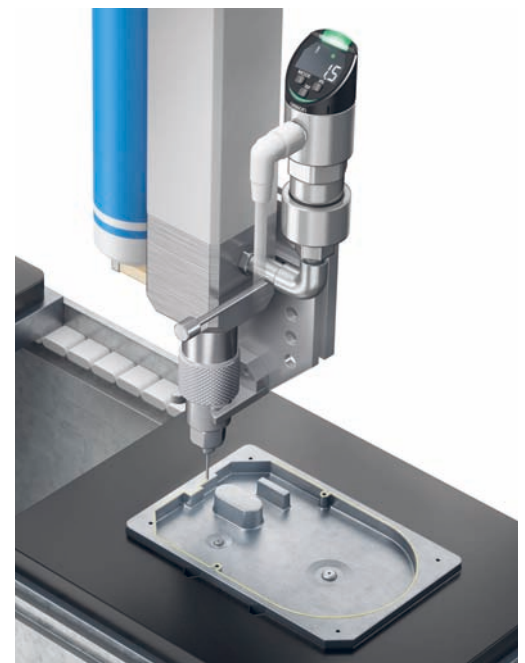
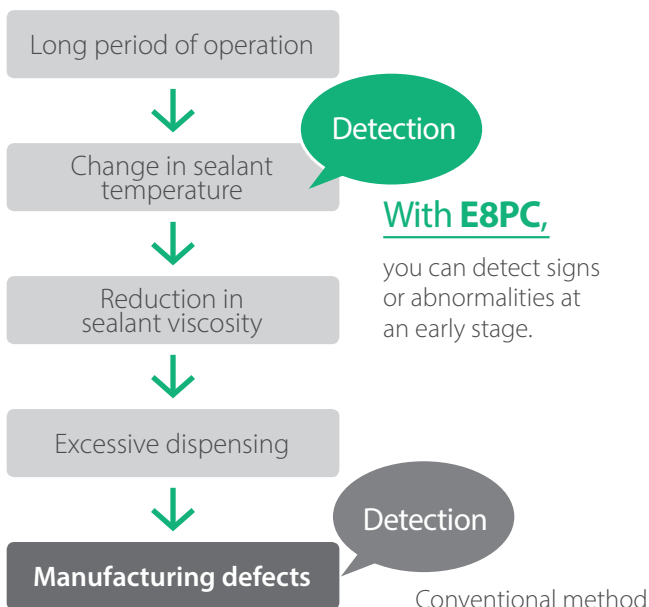



Multi-sensing technology

Pressure

Uses a piezoelectric element. Since the sensing surface is made of a high-hard ceramics, it withstands high pressure. Pressure values are detected from changes in resistance of the strain gauge.

Temp.

The temperature measuring element mounted to the back of the piezoelectric element measures temperature.

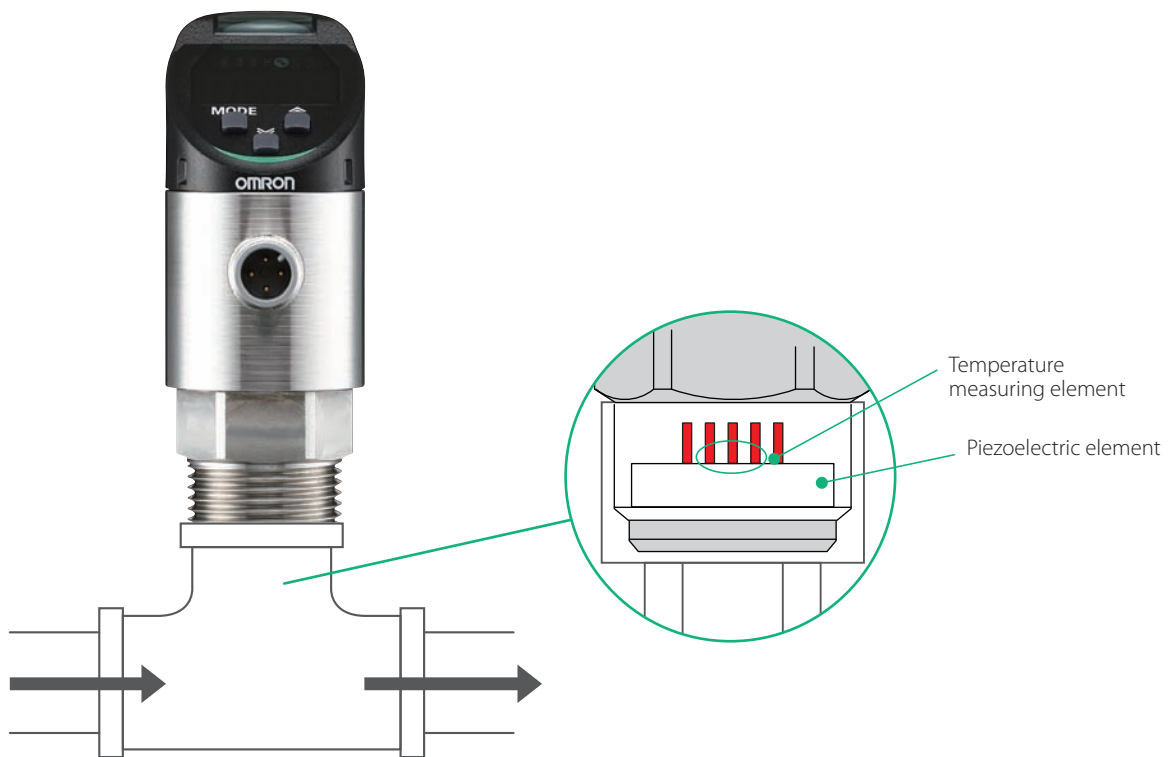

Notifications of changes in the cooling water or hydraulic oil states are easy to understand

You can see the cause of the abnormality Multi-sensing display Patent pending^{*1}

The sensor judges by monitoring "Flow rate + Temperature" and "Pressure + Temperature". Since data outputs to a PLC by the IO-Link communications is possible, it is easy to perform maintenance before entering an abnormal state. For the display colors, you can set 3 patterns, or if combined with Not lit, a total of 4 patterns.

Example of performance monitoring using IoT Flow Sensor

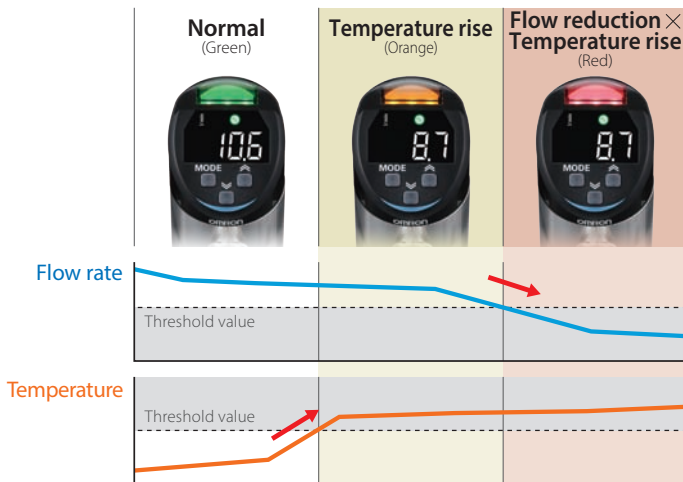

You can see the rate of change with a percentage Relative value display E8FC

With the flow rate at the time of setting as 100%, you can relatively measure the change in flow rate value. Smart Tuning function is convenient for cases where optimum value management of absolute values is difficult, such as when the operating environment is changing, and liquid types are changing, etc.



Easy to understand Display by unit

Converts to physical quantity units for display.

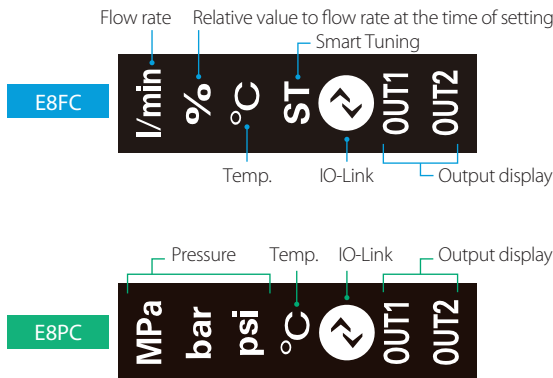

Adjustable to reference flow rate Scaling function

Detected flow rate values can be adjusted to reference flow rates (red line) of the application. This function is useful when detected flow rates deviate from reference values.

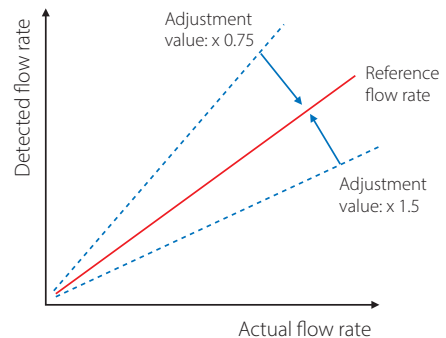

*1. "Patent pending" means that we applied for a patent in Japan, and "Patented" means that we obtained a patent in Japan. (As of July 2022)

Easy to see High luminosity LED display

A high luminosity LED gives good visibility even at the back of equipment or in dark locations.

White digital display is easy to read even from a distance.

Condition indicator is easy to read even from the opposite side.



Even if the sensor is installed in dark locations or at the back of equipment at manufacturing sites, a high luminosity LED enables you to easily read the status. You can immediately tell which sensor is showing signs of abnormalities by the colors of the indicators.



Adjust the angle according to the mounting position

Angle adjustment up to 330°

After fastening to the adapter, you can adjust the angle so that the display is easy to see.



180° reverse display

The display can rotate 180°.



Useful functions to capture equipment status

Peak/Bottom Hold function

Data at the moment when an error occurs can be identified even if no one is on site.

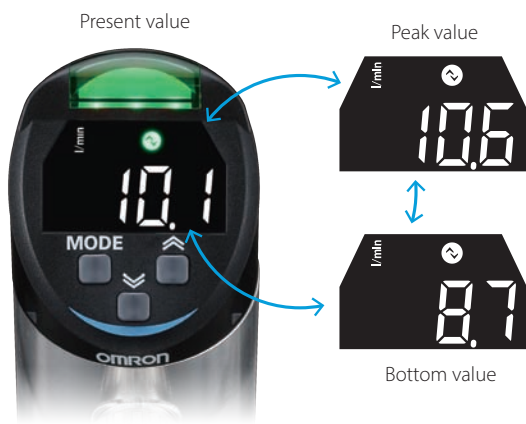

NPN/PNP selection

The output polarity can be easily switched with a button, eliminating the need to use different sensors for each polarity. This means that maintenance stock can be reduced.



Two-channel analog current output

Both flow rate or pressure values and temperature values can be output as analog currents at the same time, which enables simultaneous monitoring of two physical quantities even in equipment using only analog input devices.

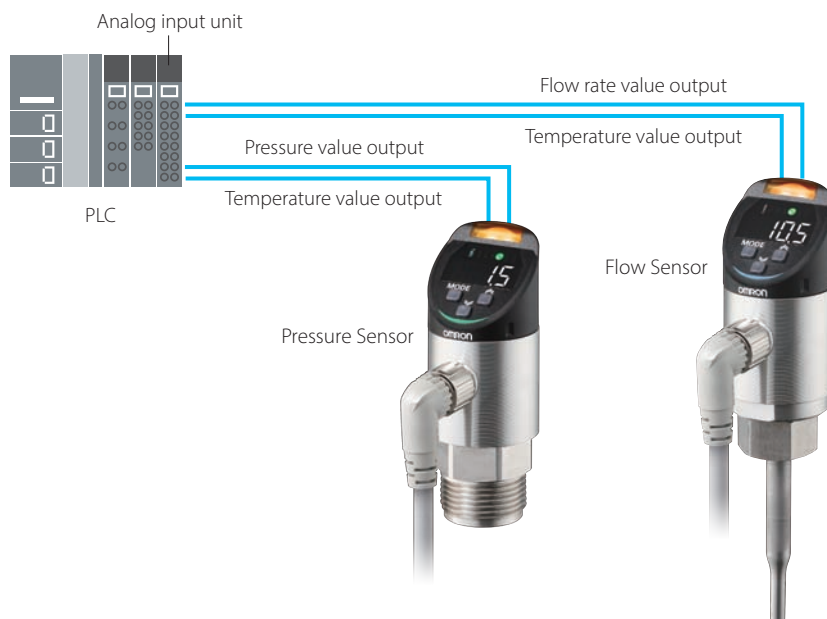

You can also see the sensor status
Self-diagnostic outputs 

Self-diagnoses the sensor's own status, and autonomously sends notification when signs of a connection error or a malfunction appears.

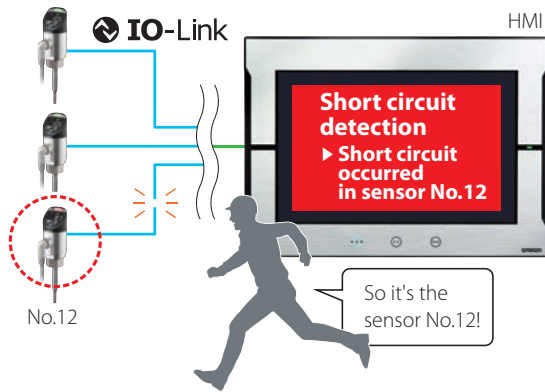

Diagnostic items during operations

- IO-Link communications status
- Internal system status of sensors
- Output load short circuit status

Batch setting from host devices 

During maintenance, the settings must be the same conditions as when the product was initially mounted. If you use the IO-Link function, you can perform batch setting from a host device. You can manage by quantifying the adjustment that is performed by skilled personnel to avoid affecting the manufacturing quality.

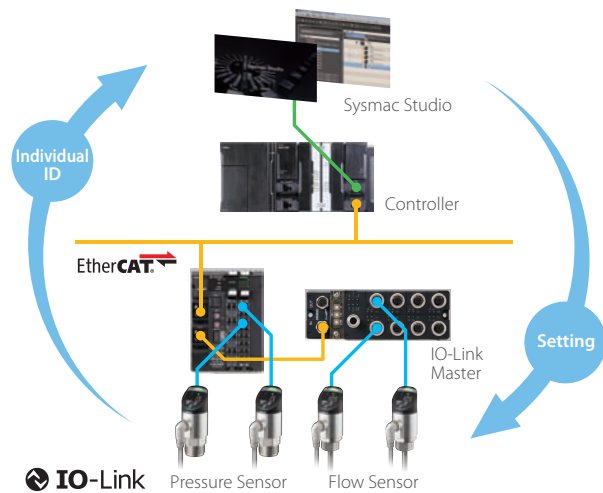

Easy visualization of on-site issues 

Data can be easily collected from sensors installed in existing equipment and monitored remotely simply by connecting the sensors to Visualization Software F-Scape that highlights on-site issues. Building a complex system and programming are no longer required.

System configuration example

Collect, store, and visualize data from existing PLC and database

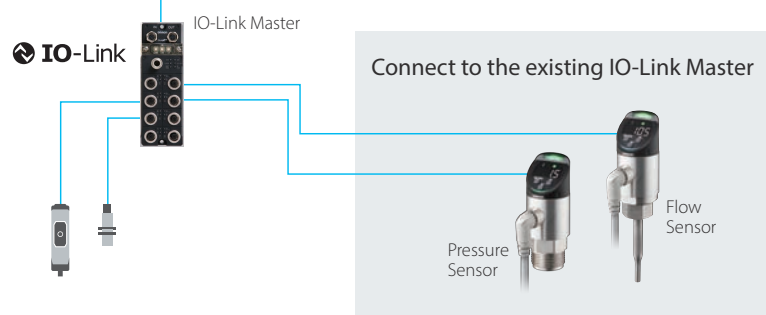

Easy to use in various location

Compact and space-saving

You can even mount in narrow spaces with multiple pipes arrayed.



Easy-to-clean structure

Structure is easily removable from the piping for periodic inspections, etc., and easily cleaned.



Expanded cable and adapter lineups (sold separately)*



* Use our dedicated adapters. In addition, if there is a possibility of pulsations or vibrations to a Pressure Sensor, we recommend the attachment of a throttle (sold separately).

Highly durable liquid contact part



E8FC
 Detecting unit: SUS304L
 O-ring: FKM



E8PC
 Pressure port: SUS304
 Diaphragm pressure port: Al₂O₃ (alumina)
 O-ring: FKM

IoT Flow Sensors E8FC

Detect signs of abnormalities in cooling water, water-soluble coolant, and water-insoluble oil by simultaneous measurement of “flow rate + temperature”



- Multi-sensing of “Flow rate + temperature” for preventing a sudden stops or manufacturing defects.
- Various lineup of replacement adapters to enable easy replacement of your current pressure gauges and flow meters.
- Analog current output function in addition to the IO-Link communications function that can perform self-diagnosis of abnormalities in the sensor itself.

For the most recent information on models that have been certified for safety standards, refer to your OMRON website.

 Refer to *Safety Precautions* on page 27.

Ordering Information





Sensors *[Refer to Dimensions on page 30.]*

Appearance	Applicable Medium	Control output	Communication method	IO-Link baud rate	Model
	Liquid	PNP/NPN selectable	IO-Link Analog	COM2	E8FC-25SD
				COM3	E8FC-25ST

Note: Please contact your OMRON sales representative regarding the IO-Link setup file (IODD file).

Adapters [Refer to Dimensions on page 30.]

It must be selected from the adapters below.



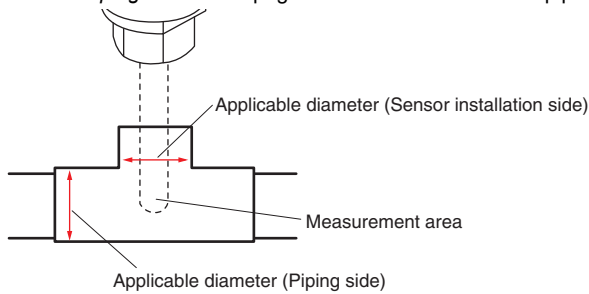

Appearance	Applicable diameter *		Thread type	Materials	Model
	Nominal diameter A	Nominal diameter B			
	10 A	3/8"	R (taper thread)	SUS304	E8FC-YA-R10A
			NPT (taper thread)		E8FC-YA-N10A
	15 A	1/2"	R (taper thread)		E8FC-YA-R15A
			NPT (taper thread)		E8FC-YA-N15A
	20 A	3/4"	R (taper thread)		E8FC-YA-R20A
			NPT (taper thread)		E8FC-YA-N20A
	25 A	1"	R (taper thread)		E8FC-YA-R25A
			NPT (taper thread)		E8FC-YA-N25A

* It is recommended that the piping fitting diameters be the same on both the piping side and the sensor mounting side. Because the sensor is designed so that the measurement area is in the center of the piping, correct measurement may not be possible with different diameter fittings. Refer to *Piping Method* on page 29 for the recommended pipe joint.



Cables (Sensor I/O Connectors) [Refer to Dimensions on page 31.]

A Cable is not provided with the Sensor. It must be ordered separately.

Type	Appearance	Cable	Model
Socket on one cable end		2 m	XS5F-D421-D80-F
		5 m	XS5F-D421-G80-F
		2 m	XS5F-D422-D80-F
		5 m	XS5F-D422-G80-F
Socket and plug on cable ends *		2 m	XS5W-D421-D81-F
		5 m	XS5W-D421-G81-F
		2 m	XS5W-D422-D81-F
		5 m	XS5W-D422-G81-F

Note: Refer to *Sensor I/O Connectors/Sensor Controllers* on OMRON website for details.
* Straight type/L-shape type combinations are also available.

O-ring (for replacement) [Refer to Dimensions on page 31.]

Appearance	Type	Model
	For E8FC-25□□	E8FC-YL-1

Ratings and Specifications

Sensors

Model	NPN/PNP selectable (COM2)	E8FC-25SD			
	NPN/PNP selectable (COM3)	E8FC-25ST			
Applicable diameter	Nominal diameter B	3/8"	1/2"	3/4"	1"
	Nominal diameter A	10 A	15 A	20 A	25 A
Applicable fluid	The fluid must not corrode the material of the wetted part (e.g. water, water-soluble coolants, insoluble oils)				
Permissible pressure *1	10 MPa				
Flow rate monitoring *2	Rated flow rate range	0.6 to 14 l/min	1 to 30 l/min	1.5 to 60 l/min	2 to 100 l/min
		Inner diameter setting (10 A, 15 A, 20 A, 25 A)			
	Display range	0 to 16 l/min	0 to 33 l/min	0 to 66 l/min	0 to 110 l/min
	Zero cutting flow rate *3	0.6 l/min	1 l/min	1.5 l/min	2 l/min
	Display resolution	0.1, 0.5, 1 l/min (Selectable)			
	Flow rate monitoring response time	Control output: 1, 2.5, 5, 10, 30, 60 s			
	Flow rate monitoring precision *4	± (7.0% of measured value + 2.0% F.S.) or less			
	Flow rate repeatability (prescribed for each response time)	1 s: ±3.5% F.S., 2.5 s: ±2.5%F.S., 5 s: ±1.6% F.S., 10 s: ±1% F.S., 30 s: ±0.8% F.S., 60 s: ±0.6%F.S.			
	Ambient temperature characteristics *5	±1.0% F.S./10°C			
Hysteresis	Variable				
Temperature monitoring *6	Temperature monitoring rated range *7	0 to 85°C			
	Temperature monitoring precision	±2.5°C			
	Temperature repeatability	±0.5°C			
Control output judgment (selectable)	Standard mode	It is judged if the measured value is the threshold value or more (or less).			
	Window mode	It is judged if the measured value is within the upper and lower limits.			
Display method	Numerical value indication: 4-digit 7-segment white LED with inverting function Status indicators: The content of indication is selectable from green, orange, red, and OFF. Output indicator: OUT1 operation (orange), OUT2 operation (orange) Unit indicator: l/min (White), % (White), °C (White), ST (White) Communication indicator: IO-Link mark (green)				
Delay setting	1 to 9999 ms (Select a function from invalid, ON delay, OFF delay, and one-shot.)				
Connection method	M12, 4-pole connector type				
Output ch1	Control output	Flow rate control output (N.O./N.C.) /temperature control output (N.O./N.C.) NPN/PNP selectable 30 VDC or less, max. 100 mA/ch, residual voltage 1 V or less			
	Analog current output *8	Flow rate analog output /temperature analog output Current output 4 to 20 mA (maximum load resistance 350Ω or less) (Display value ± 2% of FS)			
	Pulse output	1, 10, 100, 1000 l			
Output ch2	Control output	Flow rate control output (N.O./N.C.) /temperature control output (N.O./N.C.) NPN/PNP selectable 30 VDC or less, max. 100 mA/ch, residual voltage 1 V or less			
	Analog current output *8	Flow rate analog output /temperature analog output Current output 4 to 20 mA (maximum load resistance 350Ω or less) (Display value ± 2% of F.S.)			
	Pulse output	1, 10, 100, 1000 l			
	External input	Smart tuning/One-point tuning (selectable, initial status: invalid), short-circuit current 1.5 mA or less, input time 20 ms or more			

Model	NPN/PNP selectable (COM2)	E8FC-25SD
	NPN/PNP selectable (COM3)	E8FC-25ST
IO-Link	IO-Link specification	Ver 1.1
	Baud rate	E8FC-25SD: COM2 (38.4kbps) E8FC-25ST: COM3 (230.4Kbps)
	Data length	PD Size: 6 byte OD Size: 1 byte (M-sequence type: TYPE_2_V)
	Minimum cycle time	E8FC-25SD (COM2): 3.2 ms E8FC-25ST (COM3): 2.0 ms
Power supply	Power supply voltage	15 to 30 VDC (including 10% ripple (p-p)), Class 2
	Power consumption	2,880 mW or less (When power supply voltage is 30 V, current consumption must be 96 mA or less. When power supply voltage is 15 V, current consumption must be 192 mA or less.)
Protection circuit		Power supply reverse connection protection, output short-circuit protection, and output reverse connection protection
Environment resistance	Ambient temperature range	-20 to 70°C in operation and storage, respectively (no condensation)
	Applicable fluid temperature	0 to 85°C (no icing on the pipe surface)
	Ambient humidity range	35 to 85%RH in operation and storage, respectively (no condensation)
	Withstand voltage	500 VAC 50/60 Hz 1 min between charge unit package and case
	Vibration resistance (destruction)	10 to 2000 Hz, double amplitude 1.5 mm, 2 hours in X/Y/Z direction each
	Shock resistance (destruction)	500 m/s ² , three times in X/Y/Z direction each
	Protective structure	IP67
Materials	Wetted part	Detecting unit: SUS304, O-ring: FKM
	Other than wetted part	Head: PPSU, display unit: PES, button: PBT, chassis: SUS304L, nut: SUS304
Weight	Approx. 190 g	
Accessories	<ul style="list-style-type: none"> User's manual (Japanese, English, and Chinese), one each Compliance sheet Index list 	

*1. Even instantaneous pressure fluctuation such as water hammer must be within the permissible pressure.

*2. Flow monitoring performance is defined by the values measured under the following conditions using OMRON's factory adjustment equipment.

- OMRON's factory adjustment equipment: Pipe diameter 20A, straight pipe length 900 mm or more, recommended pipe joint (KITZ's PTZ-20A), dedicated adapter (E8FC-YA-R20A)
- The long side of the chassis holding unit is installed toward the upstream side of the piping. Refer to *Piping method* on page 29.
- Measured normal temperature water (approx. 23°C) under normal temperature environment (approx. 23°C)

Since each performance depends on the water level of the piping, there is a possibility that the measured value may deviate depending on the condition that the inside of the piping including the pipe joint is not filled with water, fluid pulsation, and clogging of the piping.

*3. Cutting to zero is the function outputting the flow rate less than the minimum rated flow rate as zero.

*4. The accuracy of flow rate monitoring when the pipe diameter is 20A. For piping sizes 10A, 15A and 25A, refer to *Characteristic Data* on page 21 in the catalog before use.

*5. The ambient temperature characteristics are defined by the values measured under the following conditions.

- Pipe diameter 20A, Straight pipe length: 900 mm or more, recommended pipe joint (KITZ's PTZ-20A), dedicated adapter (E8FC-YA-R20A)
- The long side of the chassis holding unit is installed toward the upstream side of the piping. Refer to *Piping method* on page 29.
- Water at room temperature (approx. 23°C) was measured at a flow rate of 30 l/min.

*6. The performance of temperature monitoring is specified by the values measured under the following conditions.

- Pipe diameter 20 A, recommended pipe joint (KITZ's PTZ-20A), dedicated adapter (E8FC-YA-R20A)
- The long side of the chassis holding unit is installed toward the upstream side of the piping. Refer to *Piping method* on page 29.
- In a normal temperature environment (approx. 23°C)

*7. If the pipe temperature exceeds 70°C, do not contact any cables with the pipe.

*8. Do not connect outputs CH1 (pin 4) or/and CH2 (pin 2) with the IO-Link master unit in analog current output mode. Otherwise the IO-Link master might fail.

Characteristic Data

The graphs below show the flow rate precision characteristics that are measured using our test equipment under the following conditions. The values are provided for reference.

- Recommended pipe joint (PTZ-20A by KITZ) , dedicated adapter (E8FC-YA-R20A)
- The long side of the sensor housing holder is installed toward the upstream side of the piping. Refer to *Piping method* on page 29.
- Measured normal temperature (approx. 23°C)
- Straight pipe length is 40D (D: inner diameter of pipe) or more

Flow rate precision characteristics for pipes

Measured normal temperature water (approx. 23°C)

Pipe diameter: 10 A

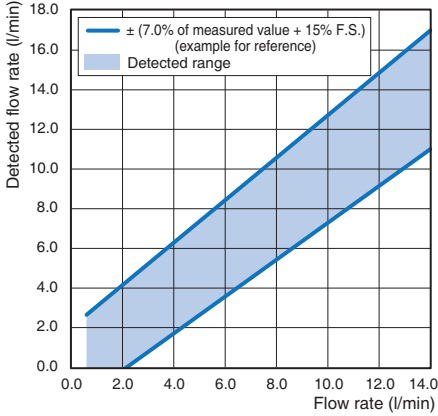

Pipe diameter: 15 A

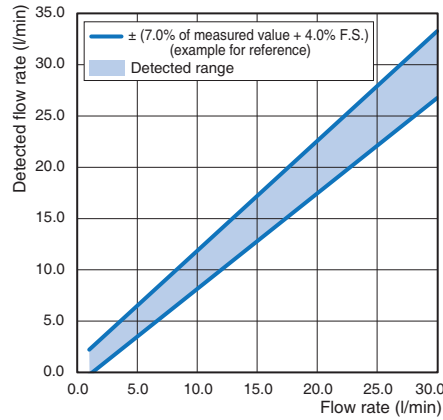

Pipe diameter: 20 A

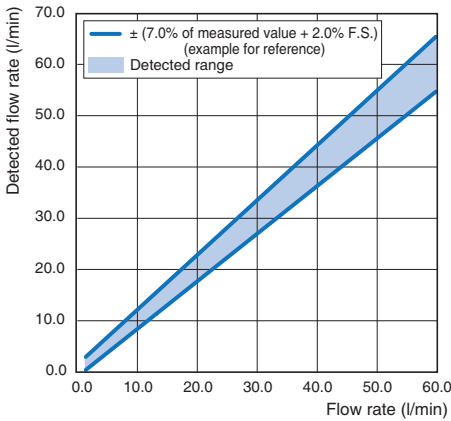

Pipe diameter: 25 A

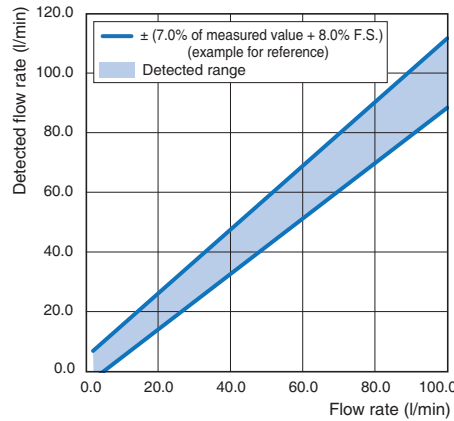

**Measured normal temperature water-soluble coolant
(Yushiron FGE180 from Yushiro Chemical Industry Co., Ltd. at approx. 23°C, dilution of 7.5%)**

Pipe diameter: 10 A

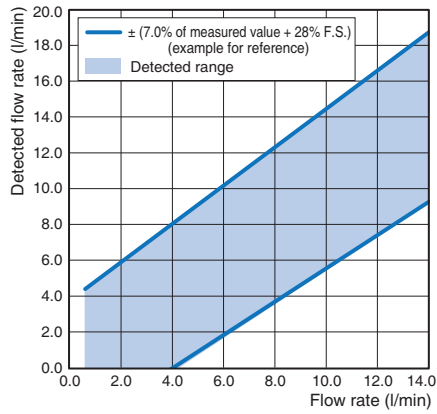

Pipe diameter: 15 A

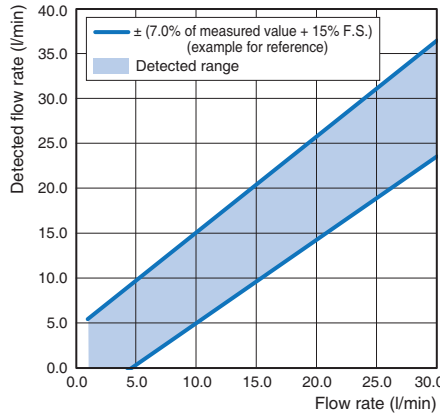

Pipe diameter: 20 A

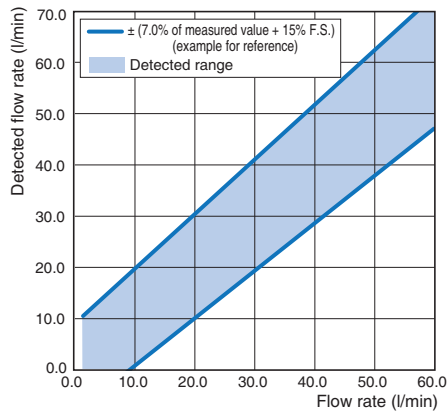

Pipe diameter: 25 A

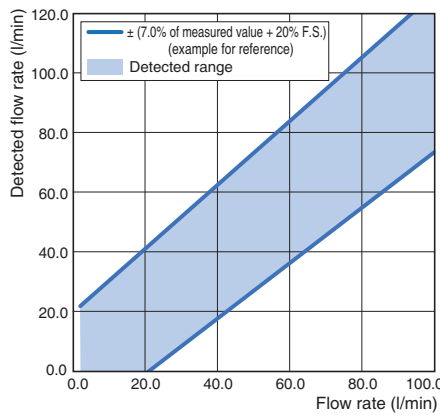

**Measured normal temperature water-insoluble oil
(Yushiron Cut Abas BZ135 from Yushiro Chemical Industry Co., Ltd. at approx. 23°C)**

Pipe diameter: 10 A

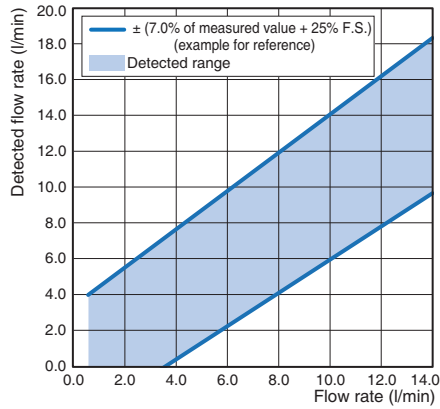

Pipe diameter: 15 A

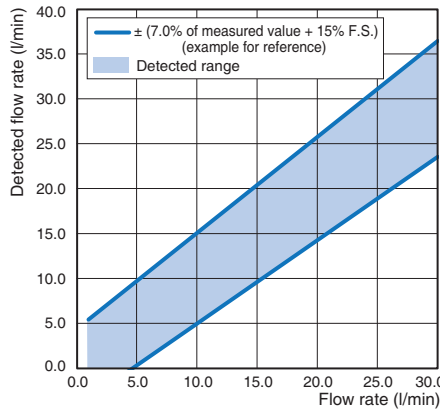

Pipe diameter: 20 A

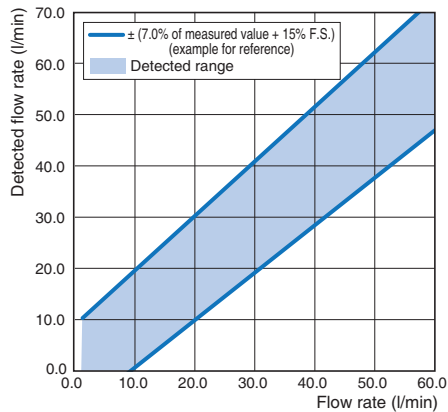

Pipe diameter: 25 A

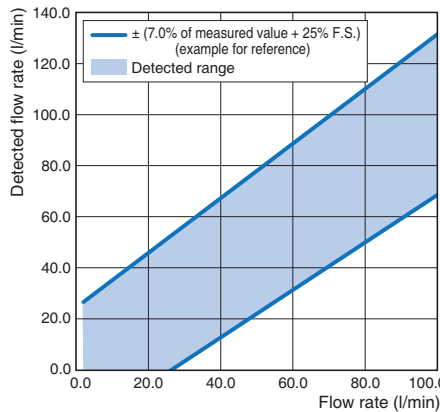

I/O Circuit Diagrams

Model	Output mode	I/O Circuit Diagrams		
		External input	Control output	Analog current output
E8FC-25SD E8FC-25ST	Standard I/O (SIO) PNP			
	IO-Link			
	Standard I/O (SIO) NPN			

Connector Pin Arrangement

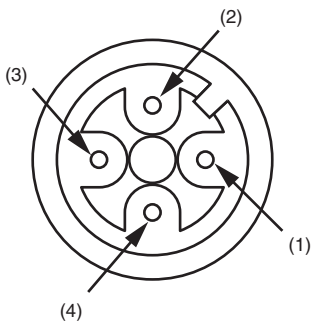

Applicable connector code: XS5F / XS5W series
 Applicable IO-Link master unit: NX/GX series

PIN No.	E8FC-25SD E8FC-25ST	
	Standard I/O mode	IO-Link mode
(1)	+V	+V
(2)	Q/Analog/EXTIN	Q/Analog
(3)	0 V	0 V
(4)	Q/Analog	C

Q: Control output
 Analog: Analog current output
 EXTIN: External input
 C: IO-Link communications

Timing Charts

The PNP output is described below by using the flow rate control output of OUT1 as an example. The activity is the same even when temperature control output is selected in OUT2.

PNP output

Output mode	N.O./N.C. setting *1	Timing charts *2	
		Standard mode	Window mode
Standard I/O mode (SIO mode)	N.O. *3	<p>Flow rate ↑ Threshold level Time</p> <p>OUT1 control output: ON (during peak), OFF (otherwise) OUT1 operation indicator (orange): ON (during peak), OFF (otherwise)</p>	<p>Flow rate ↑ Threshold level.H Threshold level.L Time</p> <p>OUT1 control output: ON (during peak), OFF (otherwise) OUT1 operation indicator (orange): ON (during peak), OFF (otherwise)</p>
	N.C.	<p>Flow rate ↑ Threshold level Time</p> <p>OUT1 control output: ON (during peak), OFF (otherwise) OUT1 operation indicator (orange): ON (during peak), OFF (otherwise)</p>	<p>Flow rate ↑ Threshold level.H Threshold level.L Time</p> <p>OUT1 control output: ON (during peak), OFF (otherwise) OUT1 operation indicator (orange): ON (during peak), OFF (otherwise)</p>
IO-Link mode	N.O. *3	<p>Flow rate ↑ Threshold level Time</p> <p>Communication indicator (Green) Lighting: ON (during peak) OUT1 control output (Byte1_bit0): 1 (during peak), 0 (otherwise) OUT1 operation indicator (orange): ON (during peak), OFF (otherwise)</p>	<p>Flow rate ↑ Threshold level.H Threshold level.L Time</p> <p>Communication indicator (Green) Lighting: ON (during peak) OUT1 control output (Byte1_bit0): 1 (during peak), 0 (otherwise) OUT1 operation indicator (orange): ON (during peak), OFF (otherwise)</p>
	N.C.	<p>Flow rate ↑ Threshold level Time</p> <p>Communication indicator (Green) Lighting: ON (during peak) OUT1 control output (Byte1_bit0): 1 (during peak), 0 (otherwise) OUT1 operation indicator (orange): ON (during peak), OFF (otherwise)</p>	<p>Flow rate ↑ Threshold level.H Threshold level.L Time</p> <p>Communication indicator (Green) Lighting: ON (during peak) OUT1 control output (Byte1_bit0): 1 (during peak), 0 (otherwise) OUT1 operation indicator (orange): ON (during peak), OFF (otherwise)</p>

*1. The N.O./N.C. setting can be changed by the operation buttons or IO-Link communications.

*2. The timer function can be set individually for OUT1 and OUT2 by the operation buttons or IO-Link communications. (Selection of ON delay, OFF delay, or one-shot function, and selection of a timer time from 1 to 9999 ms)

The delay timing of each function is same as the NPN output. Refer to the next page.

*3. Factory default

NPN output

N.O./N.C. setting *1	Timing charts *2	
	Standard mode	Window mode
N.O. *3		
N.C.		

*1. The N.O./N.C. setting can be changed by the operation buttons.

*2. The timer function can be set individually for OUT1 and OUT2 by the operation buttons.

(Selection of ON delay, OFF delay, or one-shot function, and selection of a timer time from 1 to 9999 ms)

ON delay		One-shot	
OFF delay			

*3. Factory default

Nomenclature

[Status indicators: green/orange/red]
Lit up according to the measured value and setting of Flow rate and temperature.

[Unit indicator: white]
Displays the current unit setting.

[ST indicator: white]
Lit up when smart tuning is executed.

Mode switching
[MODE] button
Calls a menu, selects (determine) a menu, and switches the unit.



[Communication indicator: green]
Lit up when IO-Link communications are in progress.

[Output indicator: orange]
Lit up when output is ON.



[Measured value:
4-digit 7-segment display (white)]
Displays the measured value.

Switch setting
[UP/DOWN] button
Changes the threshold value and setting parameters.





Safety Precautions

Be sure to read the precautions for all models in the website at: <http://www.ia.omron.com/>.

Warning Indications

 Warning	Indicates a potentially hazardous situation which, if not avoided, will result in minor or moderate injury, or may result in serious injury or death. Additionally, there may be significant property damage.
 Caution	Indicates a potentially hazardous situation which, if not avoided, may result in minor or moderate injury or in property damage.
Precautions for Safe Use	Supplementary comments on what to do or avoid doing, to use the product safely.
Precaution for Correct Use	Supplementary comments on what to do or avoid doing, to prevent failure to operate, malfunction or undesirable effect on product performance.

Meaning of Product Safety Symbols

	General Prohibition Indicates the instructions of unspecified prohibited action.
	General caution Indicates unspecified general alert.
	Caution, explosion Indicates the possibility of explosion under specific conditions.
	Caution, high temperature Indicates the possibility of injuries by high temperature under specific conditions.
	Caution, fire Indicates the possibility of fires under specific conditions.

WARNING

This product is not designed or rated for ensuring safety of persons either directly or indirectly. Do not use it for such purpose.



The specification of this product is not for beverage, food, or medical chemicals. Do not use this product for the device contacting beverage, food, or medical chemicals.



Do not use the product with voltage in excess of the rated voltage. Excess voltage may result in malfunction or fire.



This product is not assumed to be used in explosion-proof areas. Do not use the product in explosion proof areas.



Never use the product with an AC power supply. Otherwise, explosion may result.



The product might fail or be damaged. Do not stand on the sensor, or add excessive load.



Caution

The product might fail or be damaged. Piping, wiring, maintenance, and checkup must be done by operators with expertise.



The product might be damaged or fire. Do not short-circuit load.



The product might be damaged or fire. Be careful with polarity of the power supply to avoid incorrect wiring.



The user might get burned. The sensor surface temperature rises depending on the operating condition such as ambient temperature, power supply voltage, or fluid temperature. Be careful when operating or cleaning the product.



Precautions for Safe Use

The following items are necessary for ensuring safety, so be sure to observe them.

- Do not use the product in the following installation areas.
 - (1) Locations subject to direct sunlight
 - (2) Locations subject to condensation due to high humidity
 - (3) Locations subject to corrosive gas
 - (4) Locations subject to vibration or mechanical shocks exceeding the rated values
 - (5) Locations subject to exposure to water, oil, chemicals
 - (6) Locations subject to steam
 - (7) Locations subjected to strong magnetic field or electric field
- Do not use in an environment exposed to an inflammable/explosive gas
- Do not use in an ambient atmosphere or environment exceeding the rating.
- Please avoid using the product underwater, under rain, and outdoors.
- Do not use the product for any explosive or corrosive fluids.
- Do not freeze or solidify the fluid. Otherwise, the product might fail or be damaged.
- Provide a relief valve to prevent the liquid sealing circuit.
- Make sure safety before installing/replacing the sensor, for example, stop the machine or depressurize the fluid.
- In order to ensure safety of user operations and maintenance, install the product apart from high-pressure equipment or power equipment.
- When revolving the product, support the chassis holding part with a spanner.
- Wire this product separately from high-pressure wire or power wire. If wiring together with such wire or in the same duct, this product might receive induction, which might cause malfunctioning or damages.
- Be sure to turn OFF the power before wiring.
- Do not wire with a wet hand.
- Use this product under the rated or smaller load. Otherwise, the product might be damaged or catch fire.
- Connect load correctly.
- If the load and sensor use separate power supplies, turn ON the sensor's power first.
- Process unwired terminals so that they do not contact other wire or equipment.
- Do not use the product with the main unit damaged.
- Be careful with the sharp screw parts.
- Do not pull connected cables hard.
- Do not use organic solvents such as thinner or alcohol for cleaning because they deteriorate the degree of protection and indication performance.
- Do not try to disassemble, repair, or alter the main unit.
- If disposing this product, handle it as industrial waste.
- This product is certified by the UL standard based on the assumption that Class 2 circuits are used. Operate this product using Class 2 power supply in the United States or Canada.
- Use cables of Omron model XS5F-D4 series or model XS5W-D4 series.
- The  mark shown on the sensor nameplate means direct current.
- For measurement of flammable fluids, use the product at a temperature sufficiently lower than the flash point.
- The surface temperature of the detection unit becomes high. When installing or cleaning the unit, turn off the power supply before proceeding.

Precaution for Correct Use

- Do not use this product as a measuring apparatus for commercial transactions.
- Do not use this product for any fluids containing impurities.
- If the fluid is non-conductive and the pipe is made of resin, ground the chassis.
- Use the product in the condition that the fluid temperature is higher than the ambient temperature. For preventing condensation, use the product as dehumidifying by air conditioning and 30 cm or more apart from cold pipes.
- Do not add excessive impact such as falling or collision.
- To avoid malfunction or damage, use a dedicated adapter and recommended pipe joint according to the pipe diameter.
- Use the sensor when the piping is full of water.
- Apply grease to the thread parts to prevent them from getting hard to remove due to seizure.
- Fasten by the prescribed torque.
- If using the product in IO-Link mode, keep the wiring length between the master unit and sensor 20 m or less.
- Just after the power is turned ON, it might take long for the measured value to get stable according to the operating environment.
- Do not connect with the IO-Link master unit in analog output mode. This product might be damaged depending on the specification of the IO-Link master.
- Do not push the button with something sharp such as a screwdriver because doing so might damage the button.
- If using the product in an environment subject to sharp temperature variation, evaluate the product in the environment in advance.
- When implementing maintenance, use a soft brush or waste cloth so as not to damage the detecting unit or O-ring.
- When replacing the O-ring, prevent dust/dirt from being mixed into the O-ring.
- Use the sensor in an environment where excessive pressure is not applied to its detection unit.
-  This product must be disposed of in accordance with applicable laws and regulations.
- Use the product in an environment at altitudes of 2,000 m or less.
- Use the product in an environment of pollution degree 3 or less.

Piping method

- Use the adapter according to the connection pipe diameter of the piping.
- When assembling pipes, use the KITZ's PTZ piping joint (*1).
- Use a pipe joint whose applicable diameter of the piping side is equal to that of the sensor installation side.
Because the sensor is designed so that the measurement area is in the center of the piping, correct measurement may not be possible with different diameter fittings.
- Feed the fluid so that the inside of the pipe is filled up with water. Otherwise, measured values might be misaligned or fluctuate.
- When piping, ensure a straight pipe length on both upstream and downstream sides. (The measured value may deviate.)
- Mount the product so that the measurement area does not contact the piping wall. (Fig. A)
- Do not mount the product on the downward piping whose lower part is open. (Fig. B)
- In the case of horizontal piping, it is recommended to install the sensor from the side. (Fig. C)
- In the case of vertical piping, it is recommended to install the sensor such that the flow is from the bottom to the top. (Fig. D)
- The chassis holding unit can be revolved along the boundary between itself and body unit.
When revolving the body unit, support the chassis holding unit with a wrench.
- For both horizontal and vertical piping, install the product with turning the long side of the chassis holding unit to the upstream side of the piping.

[OK]

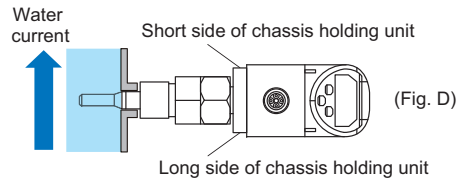
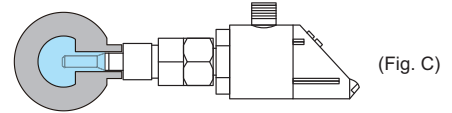

[NG]

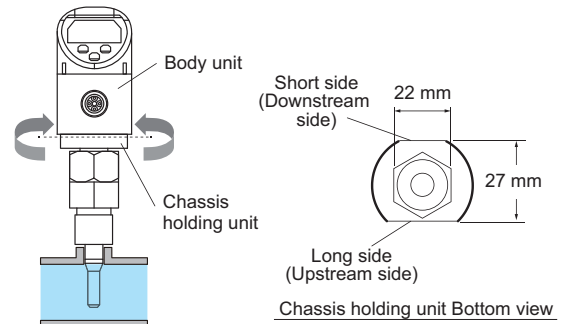
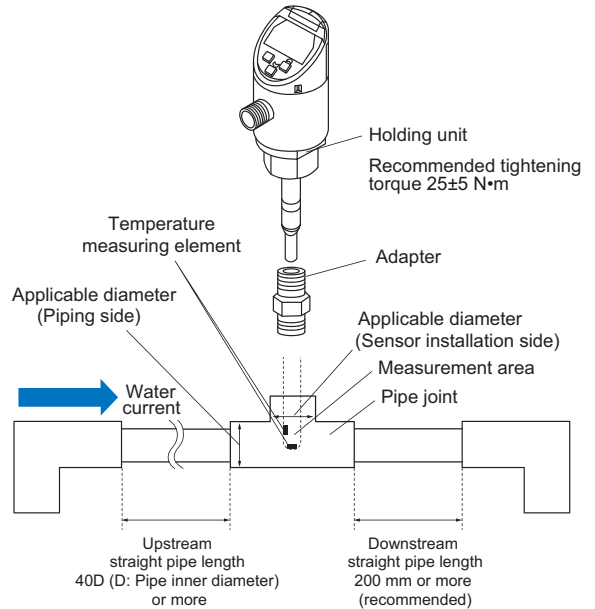
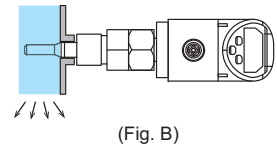
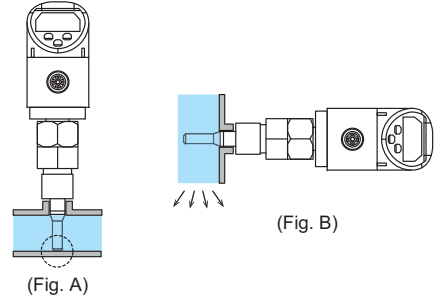

<Dedicated adapter>

- E8FC-YA-R10A E8FC-YA-N10A
- E8FC-YA-R15A E8FC-YA-N15A
- E8FC-YA-R20A E8FC-YA-N20A
- E8FC-YA-R25A E8FC-YA-N25A

*1

<Recommended Pipe joint>

- KITZ's
- PTZ-10A
- PTZ-15A
- PTZ-20A
- PTZ-25A

E8FC

Dimensions

(Unit: mm)

Tolerance class IT16 applies to dimensions in this data sheet unless otherwise specified.

Sensors

IoT Flow Sensor E8FC-25S□

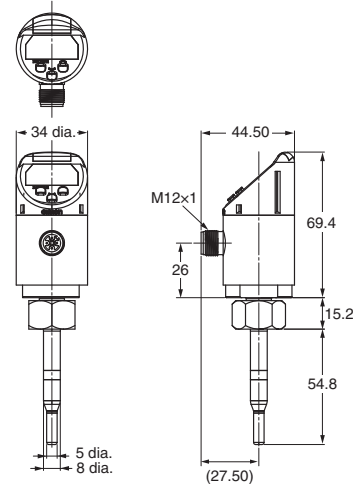

Adapters

E8FC-YA-R10A E8FC-YA-N10A

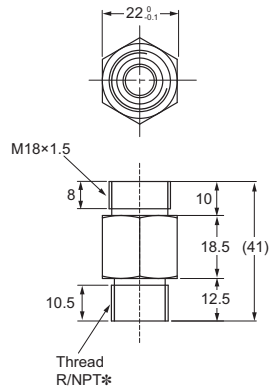

* The specification for each model is shown in the table below.

Model	E8FC-YA-R10A	E8FC-YA-N10A
Applicable diameter	10 A	
Threaded	R3/8	NPT3/8

E8FC-YA-R15A E8FC-YA-N15A

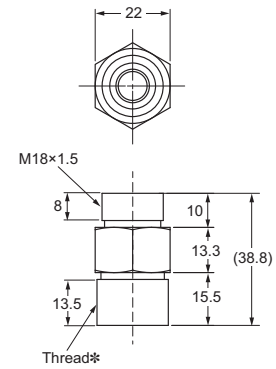

* The specification for each model is shown in the table below.

Model	E8FC-YA-R15A	E8FC-YA-N15A
Applicable diameter	15 A	
Threaded	R1/2	NPT1/2

E8FC-YA-R20A E8FC-YA-N20A

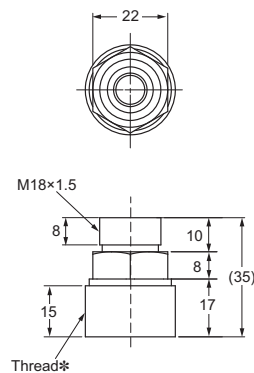

* The specification for each model is shown in the table below.

Model	E8FC-YA-R20A	E8FC-YA-N20A
Applicable diameter	20 A	
Threaded	R3/4	NPT3/4

E8FC-YA-R25A E8FC-YA-N25A

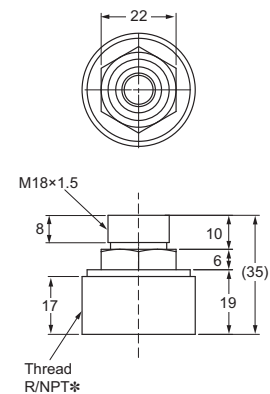

* The specification for each model is shown in the table below.

Model	E8FC-YA-R25A	E8FC-YA-N25A
Applicable diameter	25 A	
Threaded	R1	NPT1

**O-ring
E8FC-YL-1**

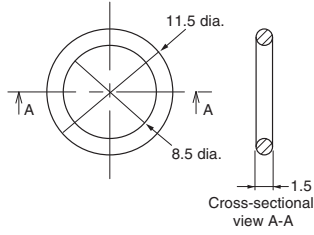

Cables

Sensor I/O Connectors (M12, Socket on one cable end)

Straight

- XS5F-D421-D80-F**
- XS5F-D421-G80-F**

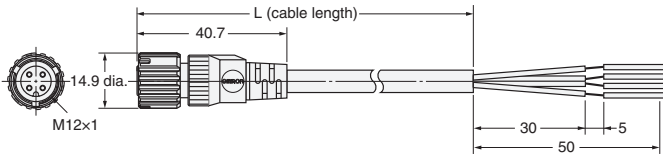

Sensor I/O Connectors (M12, Socket and plug on cable ends)

Straight/straight

- XS5W-D421-D81-F**
- XS5W-D421-G81-F**

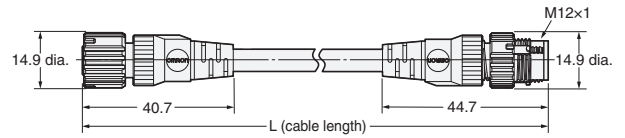

L-shaped

- XS5F-D422-D80-F**
- XS5F-D422-G80-F**

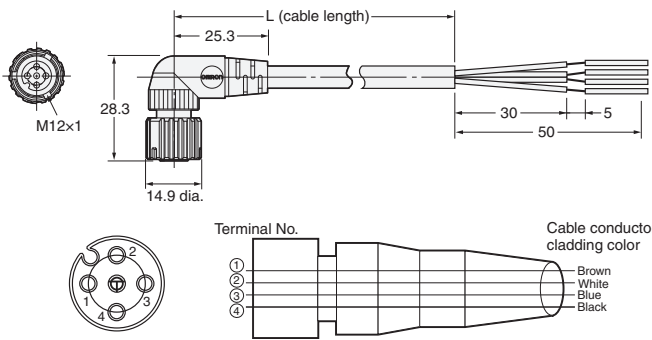

L-shaped/L-shaped

- XS5W-D422-D81-F**
- XS5W-D422-G81-F**

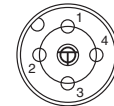
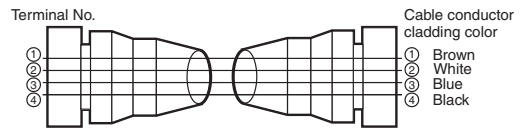
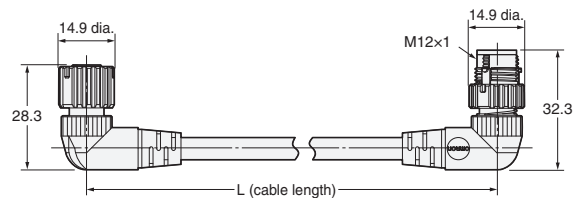

**Female (socket)
Contact side**



**Male (plug)
Contact side**

Detect signs of abnormalities in hydraulic oil and sealant by simultaneous measurement of “pressure + temperature”



- Multi-sensing of “Pressure + temperature” for preventing a sudden stops or manufacturing defects.
- Various lineup of replacement adapters to enable easy replacement of your current pressure gauges and flow meters.
- Analog current output function in addition to the IO-Link communications function that can perform self-diagnosis of abnormalities in the sensor itself.

For the most recent information on models that have been certified for safety standards, refer to your OMRON website.

Refer to *Safety Precautions* on page 42.

Ordering Information

Sensors *[Refer to Dimensions on page 44.]*





Appearance	Applicable Medium *	Rated pressure range	Control output	Communication method	IO-Link baud rate	Model
	Liquid and gas	-0.1 to +1 MPa	PNP/NPN selectable	IO-Link Analog	COM2	E8PC-010SD-E
					COM3	E8PC-010ST-E
	Liquid	0 to +10 MPa	PNP/NPN selectable	IO-Link Analog	COM2	E8PC-100SD-E
					COM3	E8PC-100ST-E
		0 to +40 MPa	PNP/NPN selectable	IO-Link Analog	COM2	E8PC-400SD-E
					COM3	E8PC-400ST-E

Note: Please contact your OMRON sales representative regarding the IO-Link setup file (IODD file).

* The applicable fluid is a liquid that do not erode the liquid contact part materials (such as water, glycol solution, and oil).

Adapters [Refer to Dimensions on page 44.]

It must be selected from the adapters below.



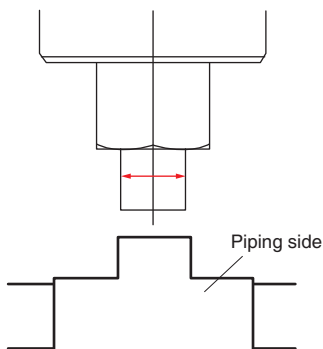

Appearance	Type	Nominal diameter of thread *		Thread type	Materials	Model
		Nominal diameter A	Nominal diameter B			
	R1/8 male	6 A	1/8"	R (taper thread)	SUS304	E8PC-YA-A18
	R1/4 male	8 A	1/4"	R (taper thread)	SUS304	E8PC-YA-A14
	R3/8 male	10 A	3/8"	R (taper thread)	SUS304	E8PC-YA-A38
	G1/4 female	8 A	1/4"	G (parallel thread)	SUS304	E8PC-YA-B14N
	NPT1/8 male	6 A	1/8"	NPT (taper thread)	SUS304	E8PC-YA-C18
	NPT1/4 male	8 A	1/4"	NPT (taper thread)	SUS304	E8PC-YA-C14

* The nominal diameter of the thread is the size of the part shown below on the adapter.



Cables (Sensor I/O Connectors) [Refer to *Dimensions* on page 31.]

A Cable is not provided with the Sensor. It must be ordered separately.



Type	Appearance	Cable	Model
Socket on one cable end	Straight 	2 m	XS5F-D421-D80-F
		5 m	XS5F-D421-G80-F
	L-shaped 	2 m	XS5F-D422-D80-F
		5 m	XS5F-D422-G80-F
Socket and plug on cable ends *	Straight/straight 	2 m	XS5W-D421-D81-F
		5 m	XS5W-D421-G81-F
	L-shaped/L-shaped 	2 m	XS5W-D422-D81-F
		5 m	XS5W-D422-G81-F

Note: Refer to *Sensor I/O Connector/Sensor Controller* on your OMRON website for details.

* Straight type/L-shape type combinations are also available.

Throttle [Refer to *Dimensions* on page 45.]



If the excessive pulsation or surge voltage is expected, use a throttle. Install it inside the adapter and use.

Appearance	Type	Material	Model
	For a male adapter	SUS304	E8PC-YS
	For a female adapter	SUS304	E8PC-YS-N

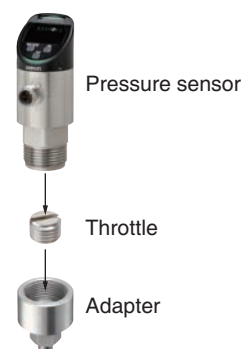
Installation method



O-ring (for replacement) [Refer to *Dimensions* on page 45.]

Appearance	Type	Model
	For E8PC-010□□	E8PC-YL-1 *
	For E8PC-100□□/-400□□	E8PC-YL-2 *
	Female for adapter G1/4	E8PC-YL-3

* Provided with the sensor.

Ratings and Specifications

Sensors

Model	NPN/PNP selectable (COM2)	E8PC-010SD-E	E8PC-100SD-E	E8PC-400SD-E
	NPN/PNP selectable (COM3)	E8PC-010ST-E	E8PC-100ST-E	E8PC-400ST-E
Pressure monitoring *1	Rated pressure range	-0.1 to 1 MPa	0 to 10 MPa	0 to 40 MPa
	Display range	-0.20 to 1.10 MPa	-0.10 to 11.00 MPa	-0.10 to 44.00 MPa
	Overload pressure *2	4 MPa	30 MPa	50 MPa
	Burst pressure	8 MPa	60 MPa	80 MPa
	Display resolution	0.001 MPa	0.01 MPa	0.01 MPa
	Applicable fluid temperature *3	-20 to +100°C (no icing or condensation)		
	Pressure response time *4	Control output: Select 3 to 6000 ms Analog output: Set value + 2 ms (90% response)		
	Pressure monitoring precision	±1.0% of F.S. or less		
	Pressure repeatability *5	±0.3% of F.S. or less		
	Ambient temperature characteristics *6	±0.6% of F.S./10°C		
	Hysteresis	Variable		
	Pressure type	Gauge pressure		
Temperature monitoring *7	Temperature monitoring rated range	-20 to 100°C		
	Temperature monitoring precision	±4°C		
	Temperature repeatability	±1°C		
Control output judgment (selectable)	Standard mode	It is judged if the measured value is the threshold value or more (or less).		
	Window mode	It is judged if the measured value is within the upper and lower limits.		
Compatible fluid	Gas and fluid not corroding the material of the wetted part (such as water, glycol solution, and oil)	The fluid must not corrode the material of the wetted part (e.g. water, water-soluble coolants, insoluble oils)		
Display method	Numerical value indication: 4-digit 7-segment white LED with inverting function Status indicator: The content of indication is selectable from green, orange, red, and OFF. Output indicator: OUT1 operation (orange), OUT2 operation (orange) Unit indication: E8PC-□□□S□: MPa (white), °C (white) E8PC-□□□S□-E: MPa (white), bar (white), psi (white), °C (white) Communication indicator: IO-Link mark (green)			
Delay setting	1 to 9999 ms (Select a function from invalid, ON delay, OFF delay, and one-shot.)			
Connection method	M12, 4-pole connector type			
Connecting diameter	G3/4 male (Use the optional adapter to convert the diameter) Connection strength 20 N·m			
Output ch1	Control output	Pressure control output (N.O./N.C.) / temperature control output (N.O./N.C.) NPN/PNP selectable 30 VDC or less, max. 100 mA/ch, residual voltage 1 V or less		
	Analog current output *8	Pressure analog output / Temperature analog output Current output 4 to 20 mA (maximum load resistance 350Ω or less) (Display value ± 2% of F.S.)		
Output ch2	Control output	Pressure control output (N.O./N.C.) / Temperature control output (N.O./N.C.) NPN/PNP selectable 30 VDC or less, max. 100 mA/ch, residual voltage 1 V or less		
	Analog current output *8	Pressure analog output / Temperature analog output Current output 4 to 20 mA (maximum load resistance 350Ω or less) (Display value ± 2% of F.S.)		
	External input	One-point teaching/zero point adjustment input (selectable, initial status: invalid) short-circuit current 1.5 mA or less, input time 20 ms or more		

Model	NPN/PNP selectable (COM2)	E8PC-010SD-E	E8PC-100SD-E	E8PC-400SD-E
	NPN/PNP selectable (COM3)	E8PC-010ST-E	E8PC-100ST-E	E8PC-400ST-E
IO-Link	IO-Link specification	Ver 1.1		
	Baud rate	E8PC-□□□SD-□: COM2 (38.4kbps) E8PC-□□□ST-□: COM3 (230.4Kbps)		
	Data length	PD Size: 6 byte OD Size: 1 byte (M-sequence type: TYPE_2_V)		
	Minimum cycle time	E8PC-□□□SD-□ (COM2): 3.2 ms E8PC-□□□ST-□ (COM3): 2.0 ms		
Power supply	Power supply voltage	10 to 30 VDC (including 10% ripple (p-p)), Class 2		
	Power consumption	1,200 mW or less (When power supply voltage is 30 V, current consumption must be 40 mA or less. When power supply voltage is 10 V, current consumption must be 120 mA or less.)		
Protection circuit		Power supply reverse connection protection, output short-circuit protection, and output reverse connection protection		
Environment resistance	Ambient temperature range	-20 to 70°C in operation and storage, respectively (no condensation)		
	Ambient humidity range	35 to 85%RH in operation and storage, respectively (no condensation)		
	Vibration resistance (destruction)	1000 VAC, 50/60 Hz, 1 min. between current-carrying parts and case		
	Shock resistance (destruction)	10 to 2000 Hz, double amplitude 1.5 mm, 2 hours in X/Y/Z direction each		
	Impact (endurance)	500 m/s ² , three times in X/Y/Z direction each		
	Protective structure	IP67		
Material	Wetted part	Pressure port: SUS304, diaphragm pressure port: Al ₂ O ₃ (alumina), O-ring: FKM		
	Other than wetted part	Head: PPSU, display unit: PES, button: PBT, chassis: SUS304L		
Weight		Approx.190 g		
Accessories		<ul style="list-style-type: none"> Throttle (Model E8PC-YS and E8PC-YS-N), one each O-ring x 1 (Model E8PC-010S□-□: Model E8PC-YL-1, Model E8PC-100S□-□/E8PC-400S□-□: Model E8PC-YL-2) User's manual (Japanese, English, and Chinese), one each Compliance sheet Index list 		

*1. The pressure precision is defined based on the values measured in the ordinary temperature environment (approx. 23°C) using water at the ordinary temperature (approx. 23°C).

*2. Even instantaneous pressure fluctuation such as water hammer must be within the withstand pressure. If instantaneous pressure fluctuation is expected, use the throttle included in the package.

*3. If the pipe temperature exceeds 70°C, do not contact any cables with the pipe.

*4. The maximum actual response time has error of 1 ms when the set response time is 3 to 10 ms, 5 ms when it is 11 to 100 ms, and +5% when it is 101 ms or more.

*5. The pressure repeatability is the error of the detection point when pressure is applied repeatedly in the ordinary temperature environment (approx. 23°C) using water at the ordinary temperature (approx. 23°C) in the rated pressure range.

*6. The ambient temperature characteristics are prescribed based on the value measured using oil as applying a pressure value of 50% of the maximum rated pressure.

*7. The temperature monitoring precision is prescribed based on the value measured using water.

Temperature measurements are affected by both of the temperatures, the medium and the piping.

Temperature measuring elements are installed on the back surface of the piezoelectric element (inside the product) and used to measure the temperature. It might take long for the measured value to get stable according to the heat transmission speed.

*8. Do not connect CH1 (pin4) or/and CH 2 (pin 2) with the IO-Link master unit in analog current output mode. Otherwise, the unit might fail.

I/O Circuit Diagrams

Model	Output mode	I/O Circuit Diagrams		
		External input	Control output	Analog current output
E8PC- □□□SD-□ E8PC- □□□ST-□	Standard I/O (SIO) PNP			
	IO-Link	/		
	Standard I/O (SIO) NPN			

Connector Pin Arrangement

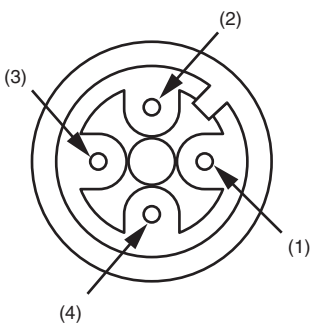

Applicable OMRON connector cables: XS5F/XS5W Series
 Applicable IO-Link master unit: NX/GX series

PIN No.	E8PC-□□□SD-□ E8PC-□□□ST-□	
	Standard I/O mode	IO-Link mode
(1)	+V	+V
(2)	Q/Analog/EXTIN	Q/Analog
(3)	0 V	0 V
(4)	Q/Analog	C

Q: Control output
 Analog: Analog current output
 EXTIN: External input
 C: IO-Link communications

Timing Charts

The timing chart is described below by using the pressure control output of OUT1 as an example.
The activity is the same even when temperature control output is set in OUT2.

PNP output

Output mode	N.O./N.C. setting *1	Timing charts *2	
		Standard mode	Window mode
Standard I/O mode (SIO mode)	N.O. *3		
	N.C.		
IO-Link mode	N.O. *3		
	N.C.		

*1. The N.O./N.C. setting can be changed by the operation buttons or IO-Link communications.

*2. The timer function can be set individually for OUT1 and OUT2 by the operation buttons or IO-Link communications.
(Selection of ON delay, OFF delay, or one-shot function, and selection of a timer time from 1 to 9999 ms)

The delay timing of each function is same as the NPN output. Refer to the next page.

*3. Factory default

NPN output

N.O./N.C. setting *1	Timing charts *2	
	Standard mode	Window mode
N.O. *3		
N.C.		

*1. The N.O./N.C. setting can be changed by the operation buttons.

*2. The timer function can be set individually for OUT1 and OUT2 by the operation buttons.

(Selection of ON delay, OFF delay, or one-shot function, and selection of a timer time from 1 to 9999 ms)

ON delay		One-shot	
OFF delay			

*3. Factory default

Nomenclature

[Status indicators: green/orange/red]
Lit up according to the measured value and setting of pressure and temperature.

[Unit indicator: white]
Displays the current unit setting.

Mode switching
[MODE] button
Calls a menu, selects (determine) a menu, and switches the unit.



[Communication indicator: green]
Lit up when IO-Link communications are in progress.

[Output indicator: orange]
Lit up when output is ON.



[Measured value:
4-digit 7-segment display (white)]
Displays the measured value.

Switch setting
[UP/DOWN] button
Changes the threshold value and setting parameters.





Safety Precautions

Be sure to read the precautions for all models in the website at: <http://www.ia.omron.com/>.

Warning Indications

 Warning	Indicates a potentially hazardous situation which, if not avoided, will result in minor or moderate injury, or may result in serious injury or death. Additionally, there may be significant property damage.
 Caution	Indicates a potentially hazardous situation which, if not avoided, may result in minor or moderate injury or in property damage.
Precautions for Safe Use	Supplementary comments on what to do or avoid doing, to use the product safely.
Precaution for Correct Use	Supplementary comments on what to do or avoid doing, to prevent failure to operate, malfunction or undesirable effect on product performance.

Meaning of Product Safety Symbols

	General Prohibition Indicates the instructions of unspecified prohibited action.
	General caution Indicates unspecified general alert.
	Caution, explosion Indicates the possibility of explosion under specific conditions.
	Caution, high temperature Indicates the possibility of injuries by high temperature under specific conditions.
	Caution, fire Indicates the possibility of fires under specific conditions.

WARNING

This product is not designed or rated for ensuring safety of persons either directly or indirectly. Do not use it for such purpose. 

The specification of this product is not for beverage, food, or medical chemicals. Do not use this product for the device contacting beverage, food, or medical chemicals 

Do not use the product with voltage in excess of the rated voltage. Excess voltage may result in malfunction or fire. 

This product is not assumed to be used in explosion-proof areas. Do not use the product in explosion proof areas. 

Never use the product with an AC power supply. Otherwise, explosion may result. 

The product might fail or be destroyed. Do not impress any pressure exceeding the rated value even instantaneously. 

The product might fail or be damaged. Do not stand on the sensor, or add excessive load. 

The fluid in the pipe might spout out. Tighten the prescribed O-ring to the pipe. 

Caution

The product might fail or be damaged. Piping, wiring, maintenance, and checkup must be done by operators with expertise. 

The product might be damaged or fire. Do not short-circuit load. 

The product might be damaged or fire. Be careful with polarity of the power supply to avoid incorrect wiring. 

The user might get burned. The sensor surface temperature rises depending on the operating condition such as ambient temperature, power supply voltage, or fluid temperature. Be careful when operating or cleaning the product. 

Precautions for Safe Use

The following items are necessary for ensuring safety, so be sure to observe them.

- Do not use the product in the following installation areas.
 - (1) Locations subject to direct sunlight
 - (2) Locations subject to condensation due to high humidity
 - (3) Locations subject to corrosive gas
 - (4) Locations subject to vibration or mechanical shocks exceeding the rated values
 - (5) Locations subject to exposure to water, oil, chemicals
 - (6) Locations subject to stream
 - (7) Locations subjected to strong magnetic field or electric field
- Do not use in an environment exposed to an inflammable/explosive gas
- Do not use in an ambient atmosphere or environment exceeding the rating.
- Please avoid using the product underwater, under rain, and outdoors.
- Do not use the product for any explosive or corrosive fluids.
- Do not froze or solidify the fluid. Otherwise, the product might fail or be damaged.
- Provide a relief valve to prevent the liquid sealing circuit.
- Make sure safety before installing/replacing the sensor, for example, stop the machine or depressurize the fluid.
- In order to ensure safety of user operations and maintenance, install the product apart from high-pressure equipment or power equipment.
- When revolving the product, support the chassis holding part with a spanner.
- Wire this product separately from high-pressure wire or power wire. If wiring together with such wire or in the same duct, this product might receive induction, which might cause malfunctioning or damages.
- Be sure to turn OFF the power before wiring.
- Do not wire with a wet hand.
- Use this product under the rated or smaller load. Otherwise, the product might be damaged or catch fire.
- Connect load correctly.

- If the load and sensor use separate power supplies, turn ON the sensor's power first.
- Process unwired terminals so that they do not contact other wire or equipment.
- Do not use the product with the main unit damaged.
- Be careful with the sharp screw parts.
- Do not pull connected cables hard.
- Do not use organic solvents such as thinner or alcohol for cleaning because they deteriorate the degree of protection and indication performance.
- Do not try to disassemble, repair, or alter the main unit.
- If disposing this product, handle it as industrial waste.
- This product is certified by the UL standard based on the assumption that Class 2 circuits are used. Operate this product using Class 2 power supply in the United States or Canada.
- Use cables of Omron model XS5F-D4 series or model XS5W-D4 series.
- The  mark shown on the sensor nameplate means direct current.
- For measurement of flammable fluids, use the product at a temperature sufficiently lower than the flash point.

Precaution for Correct Use

- Do not use this product for any fluids containing impurities.
- If the fluid is non-conductive and the pipe is made of resin, ground the chassis.
- Use the product in the condition that the fluid temperature is higher than the ambient temperature. For preventing condensation, use the product as dehumidifying by air conditioning and 30 cm or more apart from cold pipes.
- Do not add excessive impact such as falling or collision.
- Do not touch the detecting unit with bare hands.
- Apply grease to the thread parts to prevent them from getting hard to remove due to seizure.
- Fasten by the prescribed torque.
- If using the product in IO-Link mode, keep the wiring length between the master unit and sensor 20 m or less.
- Just after the power is turned ON, it might take long for the measured value to get stable according to the operating environment.
- Do not connect with the IO-Link master unit in analog output mode. This product might be damaged depending on the specification of the IO-Link master.
- Do not push the button with something sharp such as a screwdriver because doing so might damage the button.
- If using the product in an environment subject to sharp temperature variation, evaluate the product in the environment in advance.
- When implementing maintenance, use a soft brush or waste cloth so as not to damage the detecting unit or O-ring.
- When replacing the O-ring, prevent dust/dirt from being mixed into the O-ring.
- If measured value offsets after the product is used for a long period of time, use the zero-point adjustment function to correct it.
-  This product must be disposed of in accordance with applicable laws and regulations.
- Use the product in an environment at altitudes of 2,000 m or less.
- Use the product in an environment of pollution degree 3 or less.

Piping Method

- Use adapters according to the connecting diameter of the pipe.
- To use the adapter, use the prescribed O-ring.
- If it is expected that the product receives excessive pulsation or surge pressure, use the throttle.
- When revolving the product, support the chassis holding part with a spanner.
- Mount the attached ferrite core at a position located within 10 mm from the edge of the cable bushing when you use this product as CE acceptable goods.

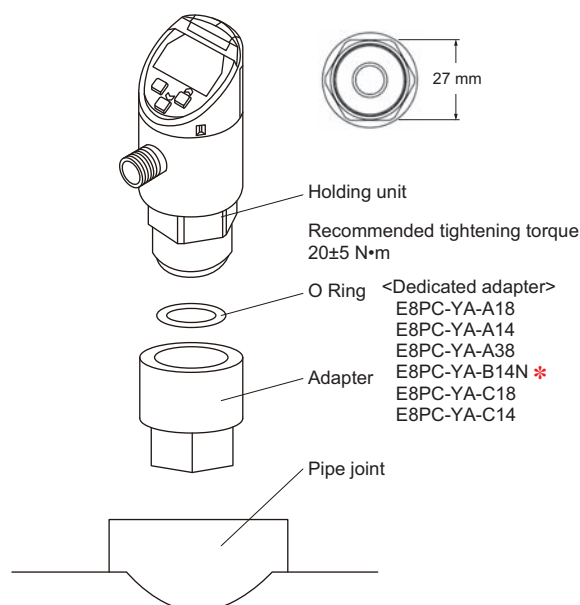
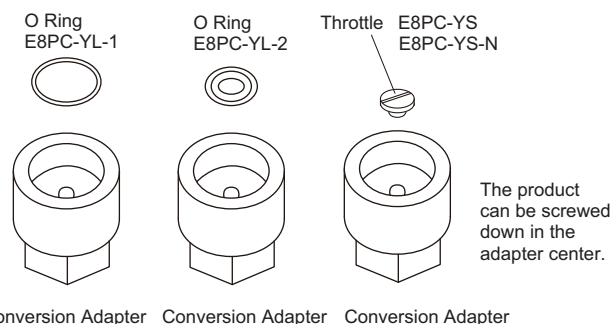

* When using the E8PC-YA-B14N dedicated adapter, use the E8PC-YL-3 O-ring on the female side of the adapter.

E8PC

Dimensions

(Unit: mm)

Sensors

IoT Pressure Sensor

E8PC-□□□S□-□

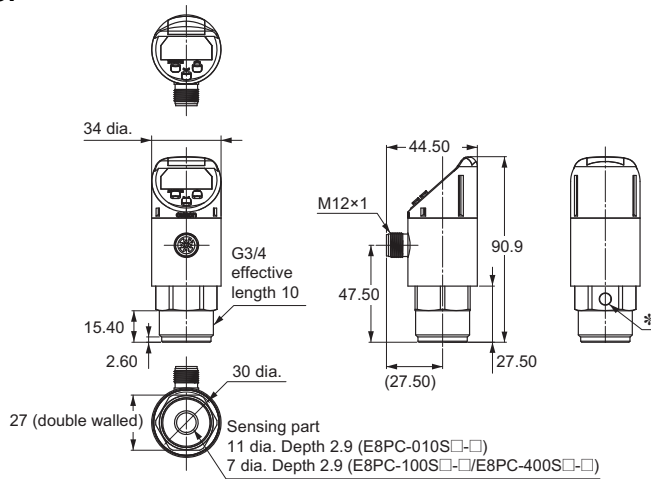

* There is no vent in E8PC-100S□-□/400S□-□.

Adapter

E8PC-YA-A□□

E8PC-YA-C□□

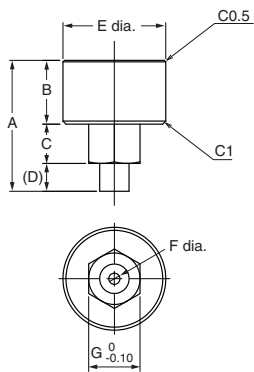

Model	E8PC-YA-A18	E8PC-YA-A14	E8PC-YA-A38	E8PC-YA-C18	E8PC-YA-C14
Thread	G3/4×R1/8	G3/4×R1/4	G3/4×R3/8	G3/4×NPT1/8	G3/4×NPT1/4
A	43.3	47.1	47.6	43.3	47.1
B	21.1				
C	13				
D	9.2	13	13.5	9.2	13
E	34				
F	3.7	4.8	5	3.7	4.8
G	17	17	19	17	17

E8PC-YA-B14N

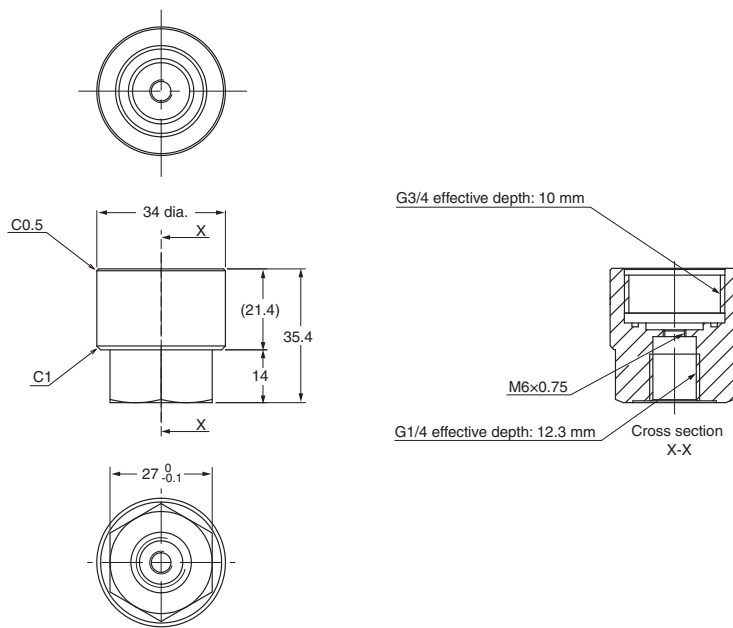

Throttle

E8PC-YS

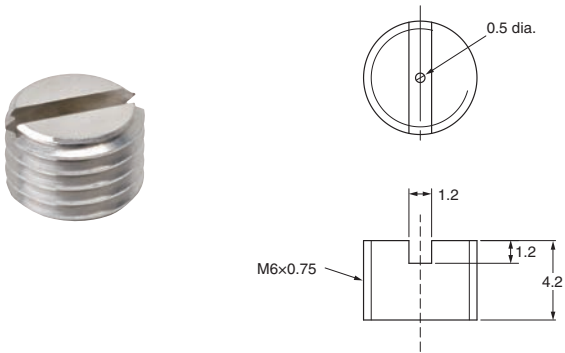

E8PC-YS-N

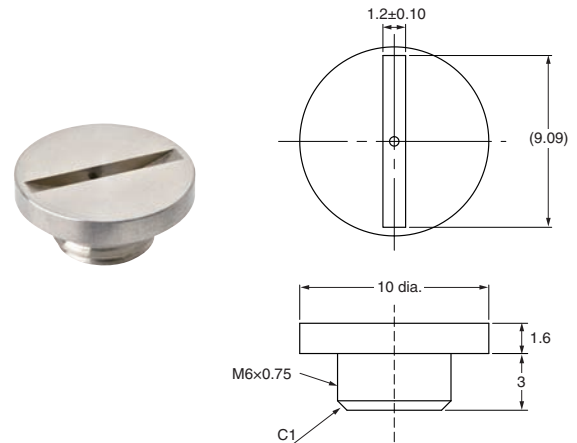

O-ring

E8PC-YL-1

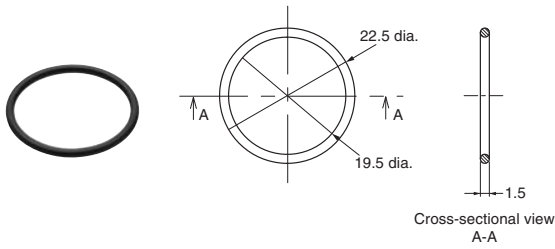

E8PC-YL-2

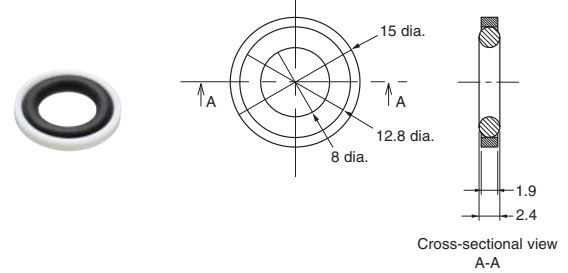

E8PC-YL-3

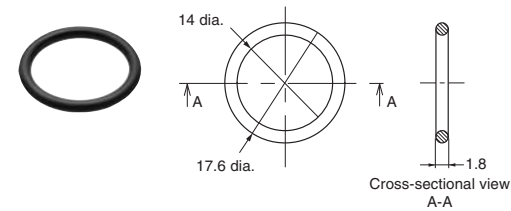

Cable

Refer to page 31 of E8FC.

Terms and Conditions Agreement

Read and understand this catalog.

Please read and understand this catalog before purchasing the products. Please consult your OMRON representative if you have any questions or comments.

Warranties.

- (a) Exclusive Warranty. Omron's exclusive warranty is that the Products will be free from defects in materials and workmanship for a period of twelve months from the date of sale by Omron (or such other period expressed in writing by Omron). Omron disclaims all other warranties, express or implied.
- (b) Limitations. OMRON MAKES NO WARRANTY OR REPRESENTATION, EXPRESS OR IMPLIED, ABOUT NON-INFRINGEMENT, MERCHANTABILITY OR FITNESS FOR A PARTICULAR PURPOSE OF THE PRODUCTS. BUYER ACKNOWLEDGES THAT IT ALONE HAS DETERMINED THAT THE PRODUCTS WILL SUITABLY MEET THE REQUIREMENTS OF THEIR INTENDED USE.

Omron further disclaims all warranties and responsibility of any type for claims or expenses based on infringement by the Products or otherwise of any intellectual property right. (c) Buyer Remedy. Omron's sole obligation hereunder shall be, at Omron's election, to (i) replace (in the form originally shipped with Buyer responsible for labor charges for removal or replacement thereof) the non-complying Product, (ii) repair the non-complying Product, or (iii) repay or credit Buyer an amount equal to the purchase price of the non-complying Product; provided that in no event shall Omron be responsible for warranty, repair, indemnity or any other claims or expenses regarding the Products unless Omron's analysis confirms that the Products were properly handled, stored, installed and maintained and not subject to contamination, abuse, misuse or inappropriate modification. Return of any Products by Buyer must be approved in writing by Omron before shipment. Omron Companies shall not be liable for the suitability or unsuitability or the results from the use of Products in combination with any electrical or electronic components, circuits, system assemblies or any other materials or substances or environments. Any advice, recommendations or information given orally or in writing, are not to be construed as an amendment or addition to the above warranty.

See <http://www.omron.com/global/> or contact your Omron representative for published information.

Limitation on Liability: Etc.

OMRON COMPANIES SHALL NOT BE LIABLE FOR SPECIAL, INDIRECT, INCIDENTAL, OR CONSEQUENTIAL DAMAGES, LOSS OF PROFITS OR PRODUCTION OR COMMERCIAL LOSS IN ANY WAY CONNECTED WITH THE PRODUCTS, WHETHER SUCH CLAIM IS BASED IN CONTRACT, WARRANTY, NEGLIGENCE OR STRICT LIABILITY.

Further, in no event shall liability of Omron Companies exceed the individual price of the Product on which liability is asserted.

Suitability of Use.

Omron Companies shall not be responsible for conformity with any standards, codes or regulations which apply to the combination of the Product in the Buyer's application or use of the Product. At Buyer's request, Omron will provide applicable third party certification documents identifying ratings and limitations of use which apply to the Product. This information by itself is not sufficient for a complete determination of the suitability of the Product in combination with the end product, machine, system, or other application or use. Buyer shall be solely responsible for determining appropriateness of the particular Product with respect to Buyer's application, product or system. Buyer shall take application responsibility in all cases.

NEVER USE THE PRODUCT FOR AN APPLICATION INVOLVING SERIOUS RISK TO LIFE OR PROPERTY OR IN LARGE QUANTITIES WITHOUT ENSURING THAT THE SYSTEM AS A WHOLE HAS BEEN DESIGNED TO ADDRESS THE RISKS, AND THAT THE OMRON PRODUCT(S) IS PROPERLY RATED AND INSTALLED FOR THE INTENDED USE WITHIN THE OVERALL EQUIPMENT OR SYSTEM.

Programmable Products.

Omron Companies shall not be responsible for the user's programming of a programmable Product, or any consequence thereof.

Performance Data.

Data presented in Omron Company websites, catalogs and other materials is provided as a guide for the user in determining suitability and does not constitute a warranty. It may represent the result of Omron's test conditions, and the user must correlate it to actual application requirements. Actual performance is subject to the Omron's Warranty and Limitations of Liability.

Change in Specifications.

Product specifications and accessories may be changed at any time based on improvements and other reasons. It is our practice to change part numbers when published ratings or features are changed, or when significant construction changes are made. However, some specifications of the Product may be changed without any notice. When in doubt, special part numbers may be assigned to fix or establish key specifications for your application. Please consult with your Omron's representative at any time to confirm actual specifications of purchased Product.

Errors and Omissions.

Information presented by Omron Companies has been checked and is believed to be accurate; however, no responsibility is assumed for clerical, typographical or proofreading errors or omissions.

- EtherCAT® is a registered trademark and patented technology, licensed by Beckhoff Automation GmbH, Germany.
- Sysmac is a trademark or registered trademark of OMRON Corporation in Japan and other countries for OMRON factory automation products.
- Other company names and product names in this document are the trademarks or registered trademarks of their respective companies.
- Image(s) used under license from Shutterstock.com.
- Microsoft product screen shot(s) reprinted with permission from Microsoft Corporation.

Note: Do not use this document to operate the Unit.

OMRON Corporation Industrial Automation Company

Kyoto, JAPAN

Contact : www.ia.omron.com

Regional Headquarters

OMRON EUROPE B.V.

Wegalaan 67-69, 2132 JD Hoofddorp
The Netherlands
Tel: (31) 2356-81-300 Fax: (31) 2356-81-388

OMRON ELECTRONICS LLC

2895 Greenspoint Parkway, Suite 200
Hoffman Estates, IL 60169 U.S.A.
Tel: (1) 847-843-7900 Fax: (1) 847-843-7787

OMRON ASIA PACIFIC PTE. LTD.

438B Alexandra Road, #08-01/02 Alexandra
Technopark, Singapore 119968
Tel: (65) 6835-3011 Fax: (65) 6835-3011

OMRON (CHINA) CO., LTD.

Room 2211, Bank of China Tower,
200 Yin Cheng Zhong Road,
PuDong New Area, Shanghai, 200120, China
Tel: (86) 21-6023-0333 Fax: (86) 21-5037-2388

Authorized Distributor:

©OMRON Corporation 2018-2024 All Rights Reserved.
In the interest of product improvement,
specifications are subject to change without notice.

CSM_4_2

Cat. No. E472-E1-05 0124 (0618)