

# CHORUS

# GEWISS

## KNX fan coil actuator 0-10V - DIN rail mounting



### GWA9141

## Technical Manual

# Contents

<b>1</b>	<b>Introduction</b> .....	<b>6</b>
<b>2</b>	<b>Application</b> .....	<b>6</b>
2.1	Warning! .....	7
2.2	Association limits .....	7
<b>3</b>	<b>“General” menu</b> .....	<b>7</b>
3.1	Parameters and objects of the “Fan” function .....	9
3.2	Parameters and objects of the “Heating” function .....	11
3.2.1	Heating installation .....	13
3.2.2	Kind of used controller .....	13
3.2.3	Activate monitoring of actuating value .....	14
3.3	Parameters and objects of the “Cooling” function .....	15
3.3.1	Cooling installation .....	17
3.3.2	Kind of used controller .....	17
3.4	Parameters and objects of the “Heating and Cooling” function.....	19
3.4.1	Kind of installation .....	21
3.4.2	Heating installation .....	21
3.4.3	Cooling installation .....	21
3.4.4	Model of heat exchanger .....	21
3.4.5	Kind of used controller .....	22
3.4.6	Format object heating/cooling .....	23
<b>4</b>	<b>“Fan” menu</b> .....	<b>24</b>
4.1	Parameters with Fan controller standard (1-3 step).....	24
4.1.1	Number of fan steps .....	24
4.1.2	Switch-on threshold for fan step 1 .....	25
4.1.3	Switch-on threshold for fan step 2 .....	25
4.1.4	Switch-on threshold for fan step 3 .....	25
4.1.5	Fan starting strategy.....	25
4.1.6	Restart delay (for split-system air conditioners).....	26
4.1.7	Minimum time to stay within a fan step .....	26
4.1.8	Additional ventilation.....	26
4.1.9	Warm start.....	27
4.1.10	Follow up time for utilisation of the remaining energy .....	27
4.1.11	Format compulsory control and limitation .....	27
4.1.12	Cyclical transmission of fan step .....	28
4.2	Parameters with Fan controller 0-10V .....	29
4.2.1	Switch ON threshold.....	29
4.2.2	Restart delay (for split-system air conditioners).....	29
4.2.3	Additional ventilation.....	29
4.2.4	Value for supplementary ventilation.....	30
4.2.5	Warm start.....	30
4.2.6	Follow up time for utilisation of the remaining energy .....	30
4.2.7	Cyclical transmission of fan object.....	31
<b>5</b>	<b>“Heating valve” menu</b> .....	<b>32</b>
5.1	Parameters .....	32
5.1.1	Time for the valve to close.....	32
5.1.2	New position at change of .....	32
5.1.3	Open for actuating value above.....	33
5.1.4	Minimum valve position .....	33
5.1.5	Maximum valve position above.....	33
5.1.6	Maximum valve position .....	33
5.1.7	Delay between heating and cooling .....	34
5.1.8	Cyclical transmission of heating status .....	34
<b>6</b>	<b>“Cooling valve” menu</b> .....	<b>35</b>
6.1	Parameters .....	35
6.1.1	Time for the valve to close.....	35
6.1.2	New position at change of .....	35
6.1.3	Open for actuating value above.....	36

6.1.4	Minimum valve position .....	36
6.1.5	Maximum valve position above.....	36
6.1.6	Maximum valve position .....	36
6.1.7	Cyclical transmission of cooling status every.....	37
<b>7</b>	<b>“Heating/cooling valve” menu .....</b>	<b>38</b>
7.1	Parameters .....	38
7.1.1	Time for the valve to close.....	38
7.1.2	New position at change of .....	38
7.1.3	Open for actuating value above .....	39
7.1.4	Minimum valve position .....	39
7.1.5	Maximum valve position above.....	39
7.1.6	Maximum valve position .....	39
7.1.7	Cyclical transmission of heating/cooling status.....	40
<b>8</b>	<b>“Auxiliary relay” menu.....</b>	<b>41</b>
8.1	Parameters .....	41
8.1.1	Switch ON auxiliary relay.....	41
8.1.2	Cyclical transmission of aux. relay status every .....	42
<b>9</b>	<b>“E1” menu .....</b>	<b>43</b>
9.1	Parameters with Function of E1 = window contact .....	43
9.1.1	Function of E1 .....	43
9.1.2	Direction of operation of window contact .....	43
9.1.3	Cyclical transmission of window contact.....	43
9.2	Parameters with Function of E1 = actual value sensor .....	44
9.2.1	Actual value offset in 0.1 K.....	44
9.2.2	Transmission of actual value at change of.....	44
9.2.3	Cyclical transmission of actual value .....	45
<b>10</b>	<b>“E2” menu .....</b>	<b>46</b>
10.1	Parameters .....	46
10.1.1	Direction of operation of contact.....	46
10.1.2	Cyclical transmission of E2 status .....	46
<b>11</b>	<b>“Drip tray monitoring” menu.....</b>	<b>47</b>
11.1	Parameters .....	47
11.1.1	Source of drip tray monitoring.....	47
11.1.2	Direction of operation of contact.....	47
11.1.3	Behaviour in case of drip tray alarm .....	48
11.1.4	Cyclical transmission of alarm status.....	48
<b>12</b>	<b>“Set point adjustment” menu.....</b>	<b>49</b>
12.1	Parameters .....	49
12.1.1	Set point adjustment from.....	49
12.1.2	Adjustment.....	49
12.1.3	Format of the adjustment value .....	50
12.1.4	Base set point without adjustment .....	50
12.1.5	Cyclical transmission of set point adjustment .....	50
12.1.6	Use set point adjustment for regulation .....	51
<b>13</b>	<b>“Set point values” menu.....</b>	<b>52</b>
13.1	Parameters with the supported function Heating .....	52
13.1.1	Base set point after reset.....	52
13.1.2	Reduction in standby operating mode .....	52
13.1.3	Reduction in night operating mode .....	52
13.1.4	Set point value for frost protection mode .....	53
13.1.5	Cyclical transmission of set point value .....	53
13.2	Parameters with the supported function Cooling .....	53
13.2.1	Base set point after reset.....	53
13.2.2	Increasing in standby mode.....	53
13.2.3	Increasing in night mode.....	54
13.2.4	Set point value for heat protection .....	54
13.2.5	Cyclical transmission of current set point value .....	54
13.3	Parameters with the supported function Heating/Cooling .....	55
13.3.1	Base set point after reset.....	55
13.3.2	Reduction in standby operating mode at heating.....	55
13.3.3	Reduction in night operating mode at heating .....	55

13.3.4	Set point value for frost protection (at heating)	56
13.3.5	Dead zone between heating and cooling	56
13.3.6	Increasing in standby mode at cooling	56
13.3.7	Increasing in night mode at cooling	56
13.3.8	Set point value for heat protection (at cooling)	56
13.3.9	Current set point value in comfort mode	56
13.3.10	Cyclical transmission of current set point value	57
<b>14</b>	<b>“Regulation” menu</b>	<b>58</b>
14.1	Parameters with the supported function Heating	58
14.1.1	Setting of control parameters	58
14.1.2	Proportional band of heating controller	58
14.1.3	Integral action time constant of heating controller	59
14.1.4	Transmission of actuating value	59
14.1.5	Cyclical transmission of actuating value every	59
14.1.6	Report when heating required but heating disabled	59
14.1.7	Report cyclically	59
14.2	Parameters with the supported function Cooling	60
14.2.1	Setting of control parameters	60
14.2.2	Proportional band of cooling controller	60
14.2.3	Integral time of cooling controller	60
14.2.4	Transmission of actuating value	61
14.2.5	Cyclical transmission of actuating value every	61
14.2.6	Report when cooling required but cooling disabled	61
14.2.7	Report cyclically	61
14.3	Parameters with the supported function Heating/Cooling	62
14.3.1	Setting of control parameters	62
14.3.2	Proportional band of heating controller	62
14.3.3	Integral action time constant of heating controller	63
14.3.4	Proportional band of cooling controller	63
14.3.5	Integral time of cooling controller	63
14.3.6	Heating/Cooling	63
14.3.7	Format object heating/cooling	64
14.3.8	Transmission of actuating value	64
14.3.9	Cyclical transmission of actuating value every	64
14.3.10	Report when no energy medium	64
14.3.11	Report cyclically	64
<b>15</b>	<b>“Operating mode and operation” menu</b>	<b>65</b>
15.1	Parameters	65
15.1.1	Operating mode after reset	65
15.1.2	Cyclical transmission of current op. mode every	65
15.1.3	Mode setting objects	66
15.1.4	Kind of presence detector	66
15.1.5	Time for comfort extension	67
15.1.6	Manual offset applies	67
15.1.7	Limitation of manual value increasing/decreasing	67
<b>16</b>	<b>“Filter monitoring” menu</b>	<b>68</b>
16.1	Parameters	68
16.1.1	Message for filter change after duty time of (1..127 weeks)	68
16.1.2	Transmit filter replacement cyclically	68
16.1.3	Transmit fan duty time (in hours)	69
16.1.4	Cycle time for filter replacement and fan duty time	69
<b>17</b>	<b>“Actuating value loss” menu</b>	<b>70</b>
17.1	Parameters	70
17.1.1	Monitoring time for actuating value	70
17.1.2	Substitute actuating value emergency program	70
17.1.3	Report actuating value loss cyclically (1= no act. value)	71
17.1.4	Report cyclically	71
<b>18</b>	<b>Annex 1: Initial start-up</b>	<b>72</b>
18.1	Test mode	72
18.2	Device LEDs in automatic mode	75
<b>19</b>	<b>Annex 2: Functional temperature control specifications</b>	<b>76</b>
19.1	Control variable monitoring	76

19.1.1	Use .....	76
19.1.2	Principle .....	76
19.1.3	Practice .....	76
19.2	Characteristic valve curve setting .....	77
19.3	Nominal value adjustment .....	78
19.4	Nominal value adaptation .....	78
19.4.1	Using with the built-in regulator .....	78
19.4.2	Using with an external regulator .....	78
19.4.3	Format of the nominal value correction: relative .....	78
19.4.4	Format of the nominal value correction: absolute .....	81
19.5	Frost Protection mode (or heat protection) with window contact .....	83
19.5.1	With external regulator .....	83
19.5.2	With built-in regulator .....	83
19.6	Dead zone .....	83
19.7	Determining the active mode .....	83
19.7.1	New modes .....	83
19.7.2	Old mode .....	84
19.7.3	Determining the nominal value .....	85
19.7.4	Heating and Cooling in a 2-pipe system .....	87
19.7.5	Heating and Cooling in a 4-pipe system .....	88
19.8	Fan check .....	88
19.8.1	Priorities .....	88
19.8.2	Forced fan mode .....	89
19.8.3	Time between heating and cooling and tail-off time .....	90
19.8.4	Hysteresis .....	91
19.9	Regulating the temperature .....	92
19.9.1	Introduction .....	92
19.9.2	Behaviour of the P regulator .....	93
19.9.3	Behaviour of the PI regulator .....	94
<b>20</b>	<b>Annex 3: Technical data of the GWA9141 device .....</b>	<b>95</b>
<b>21</b>	<b>Annex 4: Communication objects .....</b>	<b>96</b>

# 1 Introduction

This manual explains the functions of the “**Fan coil actuator 0-10V**” (GWA9141), and how they are set and configured using the ETS configuration software.

# 2 Application

GWA9141 is an actuator for fan coils 1-10V and can be used on 2-pipe and 4-pipe systems. It can command a fan coil with heating or cooling proportional valves 0-10V and up to 3 ventilation levels, or with a proportional output 0-10V. All the 0-10V outputs can only be connected to a low functional voltage with basic insulation (at least basic insulation from the mains supply).

GWA9141 has 2 zero-potential inputs for window contacts or for measuring the temperature and monitoring the drip tray.

An additional relay can command an electric heating or cooling battery, and also be used as a switchover output. Simple start-up thanks to 2 button keys for the fan and heating/cooling mode (to be enabled via ETS).

The operation status is indicated by means of 9 LEDs.

Regulation is via an external control variable or the built-in ambient thermostat. If the thermostat is used, the GWA9145 - NTC 100K TEMPERATURE SENSOR must be connected to the device.

The main functions are:

- Dedicated device for commanding fan coils
- Can be used in 2-pipe and 4-pipe systems
- For proportional valves 0-10V
- For max. 3 ventilation levels
- The fan can also be commanded with a proportional output 0-10V
- Simple start-up thanks to 2 button keys for fan test and heating/cooling mode (to be enabled via ETS)
- The additional relay C1 for heating/cooling can also be used as a switchover output
- 2 zero-potential inputs for window contact or external temperature sensor (GWA9145) and drip tray monitoring
- Command via an external control variable or the built-in ambient thermostat
- Mode changeover via the presence object and the window object
- The reference temperature can be adapted in cooling mode according to the outdoor temperature
- In the case of an external regulator, a configurable emergency program can be defined. In the case of an internal regulator, the operating mode following a restart can be defined
- Monitoring of the fan coil filter via configurable signalling with an indication of the operating time

## 2.1 Warning!

### Use associated with chronothermostats and KNX thermostats

List of KNX timed thermostats and thermostats that can be used with the fan coil actuators GWA9140 and GWA9141.

- **THERMO ICE KNX wall-mounting thermostat GW16976CB/CN/CT:**  
for controlling all the functions of the fan coil actuators (that shall be configured to work with kind of used controller "remote controller") and commanding the fan in both automatic and manual mode.
- **THERMO ICE KNX flush-mounting thermostat GW16974CB/CN/CT:**  
attention - this thermostat can only be used in KNX-SYSTEM mode (configurable with ETS). For controlling the fan coil actuators (that shall be configured to work with kind of used controller "remote controller") and commanding the fan in automatic mode only - i.e. the thermostat conveys the valve opening request (0..100% byte) to the fan coil actuators, which automatically define the fan speed; the fan speed cannot therefore be controlled via the thermostat.
- **Other KNX SYSTEM timed thermostats, thermostats and probes:**  
attention - these models permit only limited use of the control functions of the fan coil actuators (that shall be configured to work with kind of used controller "remote controller"), so their validity should be evaluated for the individual situation on the basis of the application requisites.
- **KNX EASY timed thermostats, thermostats and probes:**  
attention - these models cannot be used to control the fan coil actuators.

## 2.2 Association limits

Maximum number of group addresses:	64
Maximum number of associations:	64

This means that up to 64 group addresses can be defined, and up to 64 associations can be made between communication objects and group addresses.

## 3 “General” menu

The **General** menu contains the parameters used to enable the various functions implemented by the device, and to set the main operating parameters.

Depending on the value defined in the “**Supported functions**” and “**Kind of used controller**” parameters, other parameters of the **General** menu and other menus will be made visible in the left-hand column to allow you to configure the required function.

The “**Supported functions**” parameter is used to specify the function supported by the fan coil actuator. The values that can be set are:

- Fan
- Heating
- Cooling
- **Heating and Cooling** (default value)

The parameters “**Test mode**”, “**Report filter change**”, “**Switch fan between Auto and forced mode**” are visible in the menu **General** regardless of the type of function supported, so they are shown below and then not repeated again in this manual.

With the “**Test mode**” parameter, the user can enable the possibility to switch to “Test mode” in the first minute after reset, or else disable test mode. The possible values are:

- **disabled** (default value)
- enabled during 1 min. after reset

If “**disabled**” is set, test mode is not possible.

If “**enabled during 1 min. after reset**” is set, the user can switch to “Test mode” after a reset by activating a button key. The **Testmode active** (DPT 1.003 Enable object) will be made visible so the device can signal the activation of test mode on the BUS (value “1” =Test mode).

For the “Test mode” procedure, useful during the initial device start-up, refer to [par. 18.1 “Test mode”](#).

The “**Report filter change**” parameter allows the actuator to signal the need for a filter change after a certain number of operating weeks (set via the specific “**Filter monitoring**” menu) and operating hours. The possible values are:

- **no** (default value)
- yes

Setting “**yes**” will visualise the “**Filter monitoring**” menu, where the user can set the parameters for signalling a filter change, along with the **Fan duty time since last filter change** (DPT 7.007 time -h) object that sends the current status of the internal fan operating hour counter (the operating time is sent in hours) and **Change filter** (DPT 1.001 Switch) which has two functions:

1. Transmission object:  
Sends a “1” when the configured fan operating time has been reached.  
See the “**Message for filter change after duty time of (1..127 weeks)**” parameter in the “**Filter monitoring**” menu
2. Receiving object:  
Reset of the **Change filter** status and the fan operating hour counter (**Fan duty time since last filter change** object). 0 = Reset.

The “**Switch fan between Auto and forced mode**” parameter is used to specify the value assumed by the “**Manual mode**” (DPT 1.001 Switch object) that activates the forced contribution of the fan. The ventilation level required via forcing is defined via the 1-byte “**Forced fan step**” (DPT 5.001 Scaling) object, sending a percentage value between 0% and 100%, or as a level (1-3), depending on the setting of the “**Format compulsory control and limitation**” parameter in the **Fan** menu.

With a 0-10V fan command, only the percentage value format is allowed.

The possible values are:

- **Via obj. Forced/auto, forced = 1** (default value)
- Via obj. Auto/forced, forced = 0

If “**Via obj. Forced/auto, forced = 1**” is set, the **Manual mode** object will activate forcing if the value 1 is received, or go into automatic mode if the value 0 is received.

If “**Via obj. Auto/forced, forced = 0**” is set, the **Manual mode** object will activate forcing if the value 0 is received, or go into automatic mode if the value 1 is received.

The forced fan contribution has no effect on valve control.

#### Example:

Registered forced telegrams with the following settings on the “*Fan*” parameter page:

Switch-on threshold for fan step 1 = 10%

Switch-on threshold for fan step 2 = 40%



Switch-on threshold for fan step 3 = 70%

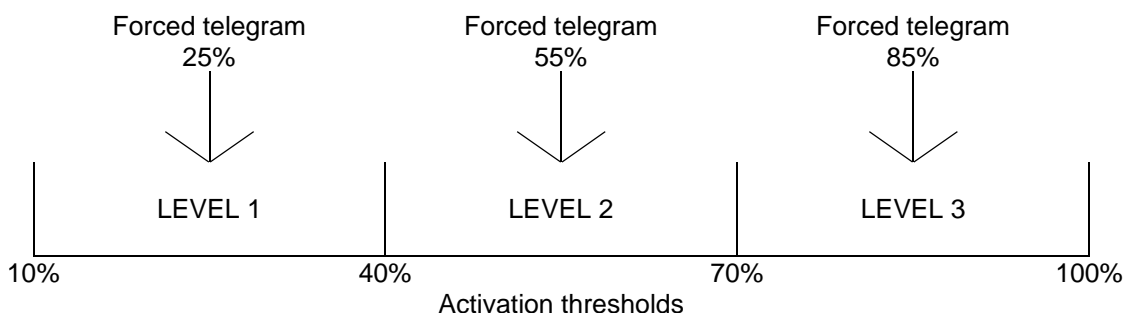

### 3.1 Parameters and objects of the “Fan” function

The menu that appears with “Supported functions” set on “fan” is the following:

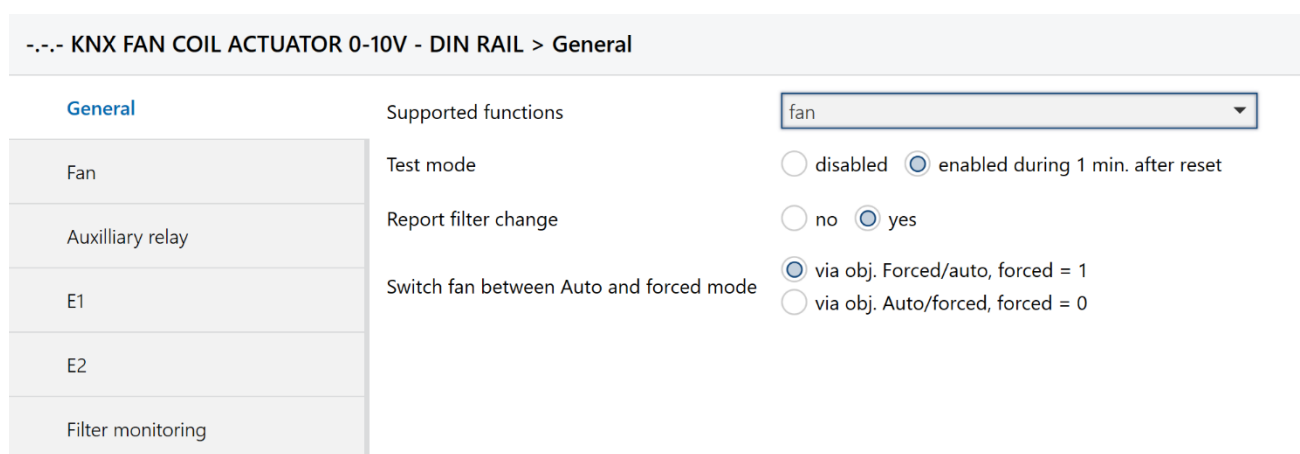

Fig. 3.1 – Menu with Supported functions = fan

With the “fan” supported function, there are no other parameters apart from those already described in ch. 3 **General** menu. The following communication objects are visible and accessible:

- **Actuating value for fan** (DPT 5.001 Scaling). Via this 1-byte object, the actuator receives the control variable for fan command (value as %).
- **Fan step – Fan Speed** (DPT 5.010 Counter Pulses, value between 0 and 255, or DPT 5.001 Scaling, value as %). Depending on the selection made with the “**Fan Controller**” parameter in the **Fan** menu, the object signals the current fan level (0..3) or a percentage value.
- **Auxiliary relay** (DPT 1.001 Switch with the function depending on the “**Switch ON auxiliary relay**” parameter configured in the **Auxiliary relay** menu).
- **Lock additional ventilation** (DPT 1.001 Switch), used to block the “Additional ventilation” function if activated (1=lock, 0=release).
- **Fan lock** (DPT 1.001 Switch), receiving object used to block the fan (1=fan lock, 0=automatic mode).
- **Forced fan step** (DPT 5.010 Counter pulses) or **Fan speed in forced mode** (DPT Scaling %), used to set the required ventilation level (as a level (1-3) or with a value between 0 and 100%) in the fan forcing status activated via the **Manual mode** (DPT 1.001 Switch) object.

- **Limitation of fan step in %** (DPT 5.001 Scaling) or **Limitation of fan step (1-2-3)** (DPT 5.010 Counter pulses). Used to define the maximum permitted control variable and the corresponding maximum fan level, expressed as a percentage value or a level (1-3). With a 0-10V fan command, only the percentage format is allowed.  
The following values are used.

Value	Maximum permitted fan level
0%	The fan is not activated
1% - 99%	Maximum permitted fan level for normal and forced mode
100%	No limit - automatic mode (= object value after reset)

**Example:**

Configured activation thresholds:

Fan level 1, or activation threshold (with fan command 0-10V) = 10%

Fan level 2 = 40% (only with standard fan command 1-3 levels)

Fan level 3 = 70% (only with standard fan command 1-3 levels)

**Table 3.1.1: standard fan command (1-3 levels)**

Value received on object 9	Maximum fan level
0% .. 9%*	The fan is not activated
10% .. 39%	1
40% .. 69%	2
70% .. 100%**	3

\* If the value is lower than the activation threshold or below level 1, the fan cannot be activated.

\*\* The value is equal to - or higher than - the activation threshold for level 3 (i.e. no limit)

**Table 3.1.2: 0-10V fan command**

Value received on object 9	Maximum fan speed
0% .. 9% *	The fan is not activated
10% .. 99%	Value of object 9

- **Fan off** (DPT 1.001 Switch), signalling object for the fan status. Sends 1 when the fan is OFF.
- **Fan step 1, 2, 3** (DPT 1.001 Switch signal the fan status when set at level 1, 2 or 3 respectively. The number of fan levels can be set via the “**Number of fan steps**” parameter in the **Fan** menu. On the basis of the number of levels, the corresponding objects will be made visible.
- **Status of window contact at E1** (DPT 1.019 window/door), **Actual value from E1** (DPT 9.001 Temperature °C). The function and format of this object depend on the “**Function of E1** parameter set in the **E1** menu. If a window contact (only available if an external regulator is used) is connected to the input, it acts as a status object for signalling the window contact status, but if an external temperature sensor (e.g. GWA9145 - NTC 100K TEMPERATURE SENSOR) is connected, it sends - on the BUS - the ambient temperature currently measured by the sensor (this is the fixed setting if an internal regulator is used).
- **Manual mode** (DPT 1.001 Switch) activates or deactivates the forced fan contribution.
- **Status of window contact at E2** (DPT 1.019 window/door) signals the opening or closure of a window whose contact is connected to input E2. Useful if input E1 is used for an external sensor so input E2 can be used to monitor an open/closed window contact. The configuration parameters can be found in menu **E2**, only visible in **Fan** and **Heating** mode.

### 3.2 Parameters and objects of the “Heating” function

If the supported function is “**Heating**”, the menu in fig. 3.2 will be visible along with the specific “**Heating valve**” menu for configuring all the parameters needed for the device to work in heating mode.

The parameter list that appears in the **General** menu with “**Supported functions**” = “**Heating**” is the following:

--.- KNX FAN COIL ACTUATOR 0-10V - DIN RAIL > General		
<b>General</b>	Supported functions	heating
Fan	Heating installation	<input checked="" type="radio"/> Fan coil <input type="radio"/> Convector
Heating valve	Kind of used controller	<input checked="" type="radio"/> remote controller <input type="radio"/> internal controller with temp. sensor at E1
Auxilliary relay	Test mode	<input type="radio"/> disabled <input checked="" type="radio"/> enabled during 1 min. after reset
E1	Report filter change	<input type="radio"/> no <input checked="" type="radio"/> yes
E2	Activate monitoring of actuating value	<input checked="" type="radio"/> no <input type="radio"/> yes
Filter monitoring	Switch fan between Auto and forced mode	<input checked="" type="radio"/> via obj. Forced/auto, forced = 1 <input type="radio"/> via obj. Auto/forced, forced = 0

Fig. 3.2 – Supported functions = Heating

With the **Heating** supported function, the following communication objects and parameters (in addition to those already described in **ch. 3 General**) are visible and accessible:

- **Actuating value heating** (DPT 5.001 Scaling). Via this 1-byte object, the actuator receives the control variable for the heating valve (% value) if the “**Kind of used controller**” is **remote controller**, and sends the current control variable of the heating valve if the “**Kind of used controller**” is **internal controller with temp. sensor at E1**.
- **Disable heating** (DPT 1.001 Switch). This object can block the heating function (if it receives the value 1) or release the block (value 0). After the reset, the value of this object is 0 (i.e. heating permitted).
- **Heating status** (DPT 1.001 Switch). Sends the current heating status:  
1 = heating control variable higher than 0% (heating mode active).  
0 = heating control variable 0% (heating mode not currently active).
- **Fan step – Fan Speed** (DPT 5.010 Counter Pulses, value between 0 and 255, or DPT 5.001 Scaling, value as %). Depending on the selection made with the “**Fan Controller**” parameter in the **Fan** menu, the object signals the current fan level (0..3) or a percentage value.
- **Auxiliary relay** (DPT 1.001 Switch with the function depending on the “**Switch ON auxiliary relay**” parameter configured in the **Auxiliary relay** menu).
- **Lock additional ventilation** (DPT 1.001 Switch), used to block the “Additional Ventilation” function if activated (1=lock, 0=release).
- **Fan lock** (DPT 1.001 Switch), receiving object used to block the fan (1=fan lock, 0=automatic mode).
- **Forced fan step** (DPT 5.001 Scaling) used to set (with a value of 0 - 100% or a level 1-3) the required ventilation level with fan forcing activated via the **Manual mode** (DPT 1.001 Switch) object.
- **Limitation of fan step in %** (DPT 5.001 Scaling) or **Limitation of fan step (1-2-3)** (DPT 5.010 Counter pulses). Used to define the maximum permitted control variable and the corresponding maximum fan

level, expressed as a percentage value or a level (1-3). With a 0-10V fan command, only the percentage format is allowed.

The following values are used.

Value	Maximum permitted fan level
0%	The fan is not activated
1% .. 99%	Maximum permitted fan level for normal and forced mode
100%	No limit - automatic mode (= object value after reset)

**Example:**

Configured activation thresholds:

Fan level 1, or activation threshold (with fan command 0-10V) = 10%

Fan level 2 = 40% (only with standard fan command 1-3 levels)

Fan level 3 = 70% (only with standard fan command 1-3 levels)

**Table 3.2.1: standard fan command (1-3 levels)**

Value received on object 9	Maximum fan level
0% .. 9%*	The fan is not activated
10% .. 39%	1
40% .. 69%	2
70% .. 100%**	3

\* If the value is lower than the activation threshold or below level 1, the fan cannot be activated.

\*\* The value is equal to - or higher than - the activation threshold for level 3 (i.e. no limit)

**Table 3.2.2: 0-10V fan command**

Value received on object 9	Maximum fan speed
0% .. 9% *	The fan is not activated
10% .. 99%	Value of object 9

- **Fan off** (DPT 1.001 Switch), signalling object for the fan status. Sends 1 when the fan is OFF.
- **Fan step 1, 2, 3** (DPT 1.001 Switch signal the fan status when set at level 1, 2 or 3 respectively. The number of fan levels can be set via the “**Number of fan steps**” parameter in the **Fan** menu. On the basis of the number of levels, the corresponding objects will be made visible.
- **Status of window contact at E1** (DPT 1.019 window/door), **Actual value from E1** (DPT 9.001 Temperature °C). The function and format of this object depend on the “**Function of E1** parameter set in the **E1** menu. If a window contact (only available if an external regulator is used) is connected to the input, it acts as a status object for signalling the window contact status, but if an external temperature sensor (e.g. GWA9145 - NTC 100K TEMPERATURE SENSOR) is connected, it sends - on the BUS - the ambient temperature currently measured by the sensor (this is the fixed setting if an internal regulator is used).
- **Manual mode** (DPT 1.001 Switch) activates or deactivates the forced fan contribution.
- **Status of window contact at E2** (DPT 1.019 window/door) signals the opening or closure of a window whose contact is connected to input E2. Useful if input E1 is used for an external sensor so input E2 can be used to monitor an open/closed window contact. The configuration parameters can be found in menu **E2**, only visible in **Fan** and **Heating** mode.

### 3.2.1 Heating installation

This parameter is used to specify the type of heating system envisaged, selecting one of the following values:

- **Fan Coil** (default value)
- Convector

### 3.2.2 Kind of used controller

This parameter specifies the type of regulator used, i.e. an external device or the internal temperature control logic, by means of a temperature sensor connected to the device via input E1.

- **Remote controller** (default value)
- Internal controller with temp. sensor at E1

The term **remote controller** means that the regulation is made by another KNX device connected to the BUS system (e.g. the GW 16 976 Cx Thermo ICE thermostat) with the aim of sending the fan coil actuator the command and regulation objects to be implemented on the outputs (in this case, the device acts as a simple actuator).

If the regulation is made by an “**Internal controller with temp. sensor at E1**”, the device measures and autonomously manages temperature regulation by implementing it on the output load. In this case, the **Set point values, Regulation, Operating mode** and **Operation** menus are visualised, along with the following communication objects:

- **Actual value from E1** (DPT 9.001 Temperature °C). Sends the current ambient temperature measured by the sensor on the BUS. The “**Transmission of actual value at change of**” parameter in menu **E1** is used to set the method for sending the measured temperature.
- **Sensor failure** (DPT 1.001 Switch). Signals an error when the temperature sensor connection is interrupted or short-circuited.
- **Operating mode preset** (DPT 20.102 HVAC mode) or **Night mode <-> Standby** (DPT 1.001 Switch). The function and format of this object depend on the setting of the “**Mode setting objects**” parameter in the **Operating mode and Operation** menu.
- **Presence** (DPT 1.018 occupancy) or **Comfort** (DPT 1.001 Switch). The function and format of this object depend on the setting of the “**Mode setting objects**” parameter in the **Operating mode and Operation** menu.
- **Window** (DPT 1.019 window/door) or **Frost protection** (DPT 1.001 Switch). The function and format of this object depend on the setting of the “**Mode setting objects**” parameter in the **Operating mode and Operation** menu.
- **Current operating mode** (DPT 20.102 HVAC mode) sends the HVAC mode active on the device (values 1=Comfort, 2=Standby, 3=Night/Economy, 4=Frost Protection/overtemperature protection). Transmission on the BUS can be set via the “**Cyclical transmission of current op. mode every**” parameter in the **Operating mode and Operation** menu.
- **Manual adjustment** (DPT 9.002 temperature difference K). The device uses this receiving object to receive a temperature difference for adapting the ambient temperature (active nominal value) in relation to the *Base set point*, using the following formulas:

New nominal value (heating) = active nominal value + manual adjustment.

New nominal value (cooling) = active nominal value + manual adjustment + dead zone + nominal value adjustment.

Values outside the range defined in the “**Limitation of manual value increasing/decreasing**” parameter of the **Operating mode and operation** menu will be limited to the maximum or minimum value.

- **Base set point** (DPT 9.001 Temperature °C). The nominal base value is predefined for the first time during the application start-up, and saved in the “*Programmed base value*” object. It can be redefined at any time via this object (limit for the valid maximum or minimum nominal value). In the event of a BUS voltage failure, this object is saved and the last value will be restored when the voltage returns. The object can be overwritten any number of times.
- **Current set point value** (DPT 9.001 Temperature °C). Signals the current nominal temperature value.
- **Heating required but heating disabled** (DPT 1.001 Switch). Error signalling object. An error is signalled in the following cases:

**Case 1:** Heating mode has been forced via the **Heating/Cooling** object, but the ambient temperature is so much higher than the programmed temperature that cooling is required.

**Case 2:** Cooling mode has been forced via the **Heating/Cooling** object, but the ambient temperature is so much lower than the programmed temperature that heating is required.

### 3.2.3 Activate monitoring of actuating value

If “**Kind of used controller**” is set on **Remote controller** the “**Activate monitoring of actuating value**” parameter will be visualised so that control via the device can be set if the control variable is received in the standard interval. The possible values are:

- **no** (default value)
- **yes**

Setting “**yes**” visualises the **Actuating value loss** (DPT 1.001 Switch) object which signals - via the BUS - (value 1= Control variable error, 0 = Control variable OK) if the control variable is received within the monitoring window set via the parameters of the **Actuating value loss** menu.

For more information about the monitoring of the control variable, refer to [par 19.1 in Annex 2](#).

### 3.3 Parameters and objects of the “Cooling” function

If the supported function is “Cooling”, the menu in fig. 3.3 will be visible along with the “Cooling valve”, “Drip tray monitoring” and “Set point adjustment” menus described below, where you can configure all the parameters needed for the device to work in cooling mode.

The parameter list that appears in the **General** menu with “Supported functions” = “Cooling” is the following:

-.- KNX FAN COIL ACTUATOR 0-10V - DIN RAIL > General		
<b>General</b>	Supported functions	cooling
Fan	Cooling installation	<input checked="" type="radio"/> Fan coil <input type="radio"/> Convector
Cooling valve	Kind of used controller	<input checked="" type="radio"/> remote controller <input type="radio"/> internal controller with temp. sensor at E1
Auxiliary relay	Test mode	<input type="radio"/> disabled <input checked="" type="radio"/> enabled during 1 min. after reset
E1	Report filter change	<input checked="" type="radio"/> no <input type="radio"/> yes
Drip tray monitoring	Activate monitoring of actuating value	<input checked="" type="radio"/> no <input type="radio"/> yes
Set point adjustment	Switch fan between Auto and forced mode	<input checked="" type="radio"/> via obj. Forced/auto, forced = 1 <input type="radio"/> via obj. Auto/forced, forced = 0

Fig. 3.3 – Supported function = Cooling

With the **Cooling** supported function, the following communication objects and parameters are visible and accessible:

- **Actuating value cooling** (DPT 5.001 Scaling). Via this 1 byte object, the actuator receives the control variable for the cooling valve (value as %) if the “Kind of used controller” is **remote controller**, and sends the current control variable of the cooling valve if the “Kind of used controller” is **internal controller with temp. sensor at E1**.
- **Enable cooling** (DPT 1.001 Switch). This object can allow the cooling function (if it receives the value 1) or block it (value 0). After the reset, the value of this object is 1 (i.e. cooling permitted).
- **Cooling status** (DPT 1.001 Switch). Sends the current cooling status:  
1 = cooling control variable higher than 0% (cooling mode active).  
0 = cooling control variable 0% (cooling mode not currently active).
- **Fan step – Fan Speed** (DPT 5.010 Counter Pulses, value between 0 and 255, or DPT 5.001 Scaling, value as %). Depending on the selection made with the “Fan Controller” parameter in the **Fan** menu, the object signals the current fan level (0..3) or a percentage value.
- **Auxiliary relay** (DPT 1.001 Switch), with the function depending on the “Switch ON auxiliary relay” parameter configured in the **Auxiliary relay** menu.
- **Lock additional ventilation** (DPT 1.001 Switch), used to block the “Additional ventilation” function if activated (1=lock, 0=release).
- **Fan lock** (DPT 1.001 Switch), receiving object used to block the fan (1=fan lock, 0=automatic mode).
- **Forced fan step** (DPT 5.001 Scaling) used to set (with a value of 0 - 100% or a level 1-3) the required ventilation level with fan forcing activated via the **Manual mode** (DPT 1.001 Switch)) object.
- **Limitation of fan step in %** (DPT 5.001 Scaling) or **Limitation of fan step (1-2-3)** (DPT 5.010 Counter pulses). Used to define the maximum permitted control variable and the corresponding maximum fan

level, expressed as a percentage value or a level (1-3). With a 0-10V fan command, only the percentage format is allowed.

The following values are used.

Value	Maximum permitted fan level
0%	The fan is not activated
1% .. 99%	Maximum permitted fan level for normal and forced mode
100%	No limit - automatic mode (= object value after reset)

**Example:**

Configured activation thresholds:

Fan level 1, or activation threshold (with fan command 0-10V) = 10%

Fan level 2 = 40% (only with standard fan command 1-3 levels)

Fan level 3 = 70% (only with standard fan command 1-3 levels)

**Table 3.2.1: standard fan command (1-3 levels)**

Value received on object 9	Maximum fan level
0% .. 9%*	The fan is not activated
10% .. 39%	1
40% .. 69%	2
70% .. 100%**	3

\* If the value is lower than the activation threshold or below level 1, the fan cannot be activated.

\*\* The value is equal to - or higher than - the activation threshold for level 3 (i.e. no limit)

**Table 3.2.2: 0-10V fan command**

Value received on object 9	Maximum fan speed
0% .. 9% *	The fan is not activated
10% .. 99%	Value of object 9

- **Fan off** (DPT 1.001 Switch), signalling object for the fan status. Sends 1 when the fan is OFF.
- **Fan step 1, 2, 3** (DPT 1.001 Switch) signal the fan status when set at level 1, 2 or 3 respectively. The number of fan levels can be set via the “**Number of fan steps**” parameter in the **Fan** menu. On the basis of the number of levels, the corresponding objects will be made visible.
- **Status of window contact at E1** (DPT 1.019 window/door), **Actual value from E1** (DPT 9.001 Temperature °C). The function and format of this object depend on the “**Function of E1**” parameter set in the **E1** menu. If a window contact (only available if an external regulator is used) is connected to the input, it acts as a status object for signalling the window contact status, but if an external temperature sensor (e.g. GWA9145 - NTC 100K TEMPERATURE SENSOR) is connected, it sends - on the BUS - the ambient temperature currently measured by the sensor (this is the fixed setting if an internal regulator is used).
- **Manual mode** (DPT 1.001 Switch) activates or deactivates the forced fan contribution.
- **Drip tray monitoring status** (DPT 1.001 switch) The function of the object depends on the setting of the “**Source for drip tray monitoring**” parameter in the **Drip try monitoring** menu.
- **Dew point alarm** (DPT 1.001 switch). Receives dewpoint alarm telegrams (1=alarm). The behaviour is identical to that set for drip tray control.
- **Outdoor temperature** (DPT 9.001 temperature °C) receives the temperature for adjusting the nominal value ([see annex 2, par. 19.4](#)).



- **Adjust set point** (DPT 9.002 temperature difference - in K) indicates the current correction of the value programmed as figure or difference. The correction value format is defined in the **Set point adjustment** menu, via the “**Format of the adjustment value**” parameter.

### 3.3.1 Cooling installation

This parameter is used to specify the type of heating system envisaged, selecting one of the following values:

- **Fan Coil** (default value)
- Convector

### 3.3.2 Kind of used controller

This parameter specifies the type of regulator used, i.e. an external device or the internal temperature control logic, by means of a temperature sensor connected to the device via input E1.

- **Remote controller** (default value)
- Internal controller with temp. sensor at E1

The term **Remote controller** means that the regulation is made by another KNX device connected to the BUS system (e.g. the GW 16 976 Cx Thermo ICE thermostat) with the aim of sending the fan coil actuator the command and regulation objects to be implemented on the outputs (in this case, the device acts as a simple actuator).

If the regulation is made by an “**Internal controller with temp. sensor at E1**”, the device measures and autonomously manages temperature regulation by implementing it on the output load. In this case, the **Set point values, Regulation, Operating mode and operation** menus are visualised, along with the following communication objects:

- **Actual value from E1** (DPT 9.001 Temperature °C). Sends the current ambient temperature measured by the sensor on the BUS. The “**Transmission of actual value at change of**” parameter in menu **E1** is used to set the method for sending the measured temperature.
- **Sensor failure** (DPT 1.001 Switch). Signals an error when the temperature sensor connection is interrupted or short-circuited.
- **Operating mode preset** (DPT 20.102 HVAC mode) or **Night mode <-> Standby** (DPT 1.001 Switch). The function and format of this object depend on the setting of the “**Mode setting objects**” parameter in the **Operating mode and Operation** menu.
- **Presence** (DPT 1.018 occupancy) or **Comfort** (DPT 1.001 Switch). The function and format of this object depend on the setting of the “**Mode setting objects**” parameter in the **Operating mode and Operation** menu.
- **Window** (DPT 1.019 window/door) or **Frost protection** (DPT 1.001 Switch). The function and format of this object depend on the setting of the “**Mode setting objects**” parameter in the **Operating mode and Operation** menu.
- **Current operating mode** (DPT 20.102 HVAC mode) sends the HVAC mode active on the device (values 1=Comfort, 2=Standby, 3=Night/Economy, 4=Frost Protection/overtemperature protection). Transmission on the BUS can be set via the “**Cyclical transmission of current op. mode every**” parameter in the **Operating mode and Operation** menu.

- **Manual adjustment** (DPT 9.002 temperature difference K). The device uses this receiving object to receive a temperature difference for adapting the ambient temperature (active nominal value) in relation to the *Base set point*, using the following formulas:

New nominal value (heating) = active nominal value + manual adjustment.

New nominal value (cooling) = active nominal value + manual adjustment + dead zone + nominal value adjustment.

Values outside the range defined in the “**Limitation of manual value increasing/decreasing**” parameter of the **Operating mode and operation** menu will be limited to the maximum or minimum value.

- **Base set point** (DPT 9.001 temperature °C). The nominal base value is predefined for the first time during the application start-up, and saved in the “*Programmed base value*” object. It can be redefined at any time via this object (limit for the valid maximum or minimum nominal value). In the event of a BUS voltage failure, this object is saved and the last value will be restored when the voltage returns. The object can be overwritten any number of times.
- **Current set point value** (DPT 9.001 temperature °C). Signals the current nominal temperature value.
- **Cooling required but Cooling disabled** (DPT 1.001 Switch). Error signalling object. An error is signalled in the following cases:

**Case 1:** Heating mode has been forced via the **Heating/Cooling** object, but the ambient temperature is so much higher than the programmed temperature that cooling is required.

**Case 2:** Cooling mode has been forced via the **Heating/Cooling** object, but the ambient temperature is so much lower than the programmed temperature that heating is required.

### 3.4 Parameters and objects of the “Heating and Cooling” function

If the supported function is “**Heating and Cooling**”, the menu in fig. 3.4 will be visible and, depending on whether **Kind of installation** is 2-pipe or 4-pipe, also the “**Heating valve**” and “**Cooling valve**” separated menus (4-pipe) or just the “**Heating/cooling valve**” menu (2-pipe). The “**Drip tray monitoring**” and “**Set point adjustment**” menus described below will also be visualised.

The parameter list that appears in the **General** menu with “**Supported functions**” = “**Heating and Cooling**” (with the 4-pipe system type, default value) is the following:

--- KNX FAN COIL ACTUATOR 0-10V - DIN RAIL > General

General	Supported functions	heating and cooling
Fan	Model of heat exchanger	<input checked="" type="radio"/> Fan coil <input type="radio"/> Convector
Heating/cooling valve	Kind of installation	<input checked="" type="radio"/> 2-pipe system <input type="radio"/> 4-pipe system
Auxilliary relay	Kind of used controller	<input checked="" type="radio"/> remote controller <input type="radio"/> internal controller with temp. sensor at E1
E1	Format object heating/cooling	<input checked="" type="radio"/> DPT1.100 (Heating= 1 / Cooling=0) <input type="radio"/> inverted (Heating=0 / Cooling=1)
Drip tray monitoring	Test mode	<input type="radio"/> disabled <input checked="" type="radio"/> enabled during 1 min. after reset
Set point adjustment	Report filter change	<input checked="" type="radio"/> no <input type="radio"/> yes
	Activate monitoring of actuating value	<input checked="" type="radio"/> no <input type="radio"/> yes
	Switch fan between Auto and forced mode	<input checked="" type="radio"/> via obj. Forced/auto, forced = 1 <input type="radio"/> via obj. Auto/forced, forced = 0

Fig. 3.4 – Supported function = Heating and Cooling with System Type = 4-pipe system

With the **Heating and Cooling** supported function, the following communication objects and parameters are visible and accessible:

- **Actuating value heating** (DPT 5.001 Scaling) and **Actuating value cooling** (DPT 5.001 Scaling) visible if “**Kind of installation**” is set on **4-pipe system**. Via this 1-byte object, the actuator receives the control variable for the heating and cooling valve respectively (% value) if the “**Kind of used controller**” is **remote controller**, and sends the current control variable of the heating and cooling valve if the “**Kind of used controller**” is **Internal controller with temp. sensor at E1**. If “**Kind of installation**” is set on **2-pipe system**, the single object that controls both systems is **Actuating value heating/cooling** (DPT 5.001 Scaling).
- **Heating/Cooling**. (DPT 1.001 Switch). This object, only visible if “**Kind of installation**” is set on **2-pipe system**, allows the device to switch between Heating and Cooling. The value (0 = Heating, 1 = Cooling, or vice versa) can be set via the “**Format object heating/cooling**” parameter.
- **Heating status** (DPT 1.001 Switch). Sends the current heating status:  
1 = heating control variable higher than 0% (heating mode active).  
0 = heating control variable 0% (heating mode not currently active).
- **Cooling status** (DPT 1.001 Switch). Sends the current cooling status:  
1 = cooling control variable higher than 0% (cooling mode active).  
0 = cooling control variable 0% (cooling mode not currently active).
- **Fan step – Fan Speed** (DPT 5.010 Counter Pulses, value between 0 and 255, or DPT 5.001 Scaling, value as %). Depending on the selection made with the “**Fan Controller**” parameter in the **Fan** menu, the object signals the current fan level (0..3) or a percentage value.

- **Auxiliary relay** (DPT 1.001 Switch), with the function depending on the “**Switch ON auxiliary relay**” parameter configured in the **Auxiliary relay** menu.
- **Lock additional ventilation** (DPT 1.001 Switch), used to block the “Additional ventilation” function if activated (1=lock, 0=release).
- **Fan lock** (DPT 1.001 Switch), receiving object used to block the fan (1=fan lock, 0=automatic mode).
- **Forced fan step** (DPT 5.001 Scaling) used to set (with a value of 0 - 100% or a level 1-3) the required ventilation level with fan forcing activated via the **Manual mode** (DPT 1.001 Switch)) object.
- **Limitation of fan step in %** (DPT 5.001 Scaling) or **Limitation of fan step (1-2-3)** (DPT 5.010 Counter pulses). Used to define the maximum permitted control variable and the corresponding maximum fan level, expressed as a percentage value or a level (1-3). With a 0-10V fan command, only the percentage format is allowed.

The following values are used.

Value	Maximum permitted fan level
0%	The fan is not activated
1% .. 99%	Maximum permitted fan level for normal and forced mode
100%	No limit - automatic mode (= object value after reset)

#### Example:

Configured activation thresholds:

Fan level 1, or activation threshold (with fan command 0-10V) = 10%

Fan level 2 = 40% (only with standard fan command 1-3 levels)

Fan level 3 = 70% (only with standard fan command 1-3 levels)

**Table 3.2.1: standard fan command (1-3 levels)**

Value received on object 9	Maximum fan level
0% .. 9%*	The fan is not activated
10% .. 39%	1
40% .. 69%	2
70% .. 100%**	3

\* If the value is lower than the activation threshold or below level 1, the fan cannot be activated.

\*\* The value is equal to - or higher than - the activation threshold for level 3 (i.e. no limit)

**Table 3.2.2: 0-10V fan command**

Value received on object 9	Maximum fan speed
0% .. 9% *	The fan is not activated
10% .. 99%	Value of object 9

- **Fan off** (DPT 1.001 Switch), signalling object for the fan status. Sends 1 when the fan is OFF.
- **Fan step 1, 2, 3** (DPT 1.001 Switch) signal the fan status when set at level 1, 2 or 3 respectively. The number of fan levels can be set via the “**Number of fan steps**” parameter in the **Fan** menu. On the basis of the number of levels, the corresponding objects will be made visible.
- **Status of window contact at E1** (DPT 1.019 window/door), **Actual value from E1** (DPT 9.001 Temperature °C). The function and format of this object depend on the “**Function of E1**” parameter set in the **E1** menu. If a window contact (only available if an external regulator is used) is connected to the input, it acts as a status object for signalling the window contact status, but if an external temperature sensor (e.g. GWA9145 - NTC 100K TEMPERATURE SENSOR) is connected, it sends - on the BUS -

the ambient temperature currently measured by the sensor (this is the fixed setting if an internal regulator is used).

- **Manual mode** (DPT 1.001 Switch) activates or deactivates the forced fan contribution.
- **Drip tray monitoring status** (DPT 1.001 switch) The function of the object depends on the setting of the "Source for drip tray monitoring" parameter in the **Drip try monitoring** menu.
- **Dew point alarm** (DPT 1.001 switch). Receives dewpoint alarm telegrams (1=alarm). The behaviour is identical to that set for drip tray control.
- **Outdoor temperature** (DPT 9.001 Temperature °C) receives the temperature for nominal value adjustment ([see annex 2 par. 19.4](#)).
- **Adjust set point** (DPT 9.002 temperature difference – in K) indicates the current correction of the value programmed as figure or difference. The correction value format is defined in the **Set point adjustment** menu, via the "Format of the adjustment value" parameter.

### 3.4.1 Kind of installation

This parameter specifies whether the system is 2-pipe or 4-pipe. The possible values are:

- 2-pipe system
- **4-pipe system** (default value)

### 3.4.2 Heating installation

This parameter, only visible if "Kind of installation" is set on **4-pipe system**, is used to specify the type of heating system by selecting one of the following values:

- **Fan Coil** (default value)
- Convector

### 3.4.3 Cooling installation

This parameter, only visible if "Kind of installation" is set on **4-pipe system**, is used to specify the type of cooling system by selecting one of the following values:

- **Fan Coil** (default value)
- Convector

### 3.4.4 Model of heat exchanger

This parameter, only visible if "Kind of installation" is set on **2-pipe system**, is used to specify the type of heat exchanger by selecting one of the following values:

- **Fan Coil** (default value)
- Convector

### 3.4.5 Kind of used controller

This parameter specifies the type of regulator used, i.e. an external device or the internal temperature control logic, by means of a temperature sensor connected to the device via input E1.

- **Remote controller** (default value)
- Internal controller with temp. sensor at E1

The term **Remote controller** means that the regulation is made by another KNX device connected to the BUS system (e.g. the GW 16 976 Cx Thermo ICE thermostat) with the aim of sending the fan coil actuator the command and regulation objects to be implemented on the outputs (in this case, the device acts as a simple actuator).

If the regulation is made by an **"Internal controller with temp. sensor at E1"**, the device measures and autonomously manages temperature regulation by implementing it on the output load. In this case, the **Set point values, Regulation, Operating mode and operation** menus are visualised, along with the following communication objects:

- **Actual value from E1** (DPT 9.001 Temperature °C). Sends the current ambient temperature measured by the sensor on the BUS. The **"Transmission of actual value at change of"** parameter in menu **E1** is used to set the method for sending the measured temperature.
- **Sensor failure** (DPT 1.001 Switch). Signals an error when the temperature sensor connection is interrupted or short-circuited.
- **Operating mode preset** (DPT 20.102 HVAC mode) or **Night mode <-> Standby** (DPT 1.001 Switch). The function and format of this object depend on the setting of the **"Mode setting objects"** parameter in the **Operating mode and Operation** menu.
- **Presence** (DPT 1.018 occupancy) or **Comfort** (DPT 1.001 Switch). The function and format of this object depend on the setting of the **"Mode setting objects"** parameter in the **Operating mode and Operation** menu.
- **Window** (DPT 1.019 window/door) or **Frost protection** (DPT 1.001 Switch). The function and format of this object depend on the setting of the **"Mode setting objects"** parameter in the **Operating mode and Operation** menu.
- **Current operating mode** (DPT 20.102 HVAC mode) sends the HVAC mode active on the device (values 1=Comfort, 2=Standby, 3=Night/Economy, 4=Frost Protection/overtemperature protection). Transmission on the BUS can be set via the **"Cyclical transmission of current op. mode every"** parameter in the **Operating mode and Operation** menu.
- **Manual adjustment** (DPT 9.002 temperature difference K). The device uses this receiving object to receive a temperature difference for adapting the ambient temperature (active nominal value) in relation to the *Base set point*, using the following formulas:

New nominal value (heating) = active nominal value + manual adjustment.

New nominal value (cooling) = active nominal value + manual adjustment + dead zone + nominal value adjustment.

Values outside the range defined in the **"Limitation of manual value increasing/decreasing"** parameter of the **Operating mode and operation** menu will be limited to the maximum or minimum value.

- **Base set point** (DPT 9.001 temperature °C). The nominal base value is predefined for the first time during the application start-up, and saved in the *"Programmed base value"* object.

It can be redefined at any time via this object (limit for the valid maximum or minimum nominal value). In the event of a BUS voltage failure, this object is saved and the last value will be restored when the voltage returns. The object can be overwritten any number of times.

- **Current set point value** (DPT 9.001 temperature °C). Signals the current nominal temperature value.
- **No energy medium** (DPT 1.001 Switch). Error signalling object (1= Incorrect energy type) visible if “Supported functions” is set on **Heating/Cooling** and “Kind of used controller” is **internal controller with temp. sensor at E1**. Used to signal an error message when heating or cooling needs to be activated owing to the temperatures, but the status of the **Heating/Cooling** (DPT 1.001 Switch) object is in conflict with this condition (in 2-pipe systems). In 4-pipe systems, the status of object 28 **Heating/Cooling** (DPT 1.001 Switch) is taken into consideration.

### 3.4.6 Format object heating/cooling

This parameter, only visible in a 2-pipe system with built-in regulator, specifies the possible values for the **Heating/Cooling** (DPT 1.001 Switch) object for switching between Heating and Cooling.

- **DPT 1.100 (Heating=1 / Cooling=0)** (default value)
- inverted (Heating=0 / Cooling = 1)

## 4 “Fan” menu

The **Fan** menu contains the parameters for configuring the fan. Different parameters will be visible, depending on whether the “**Fan controller**” type is **standard (1-3 levels)** or **0-10V**.

### 4.1 Parameters with Fan controller standard (1-3 step)

-.- KNX FAN COIL ACTUATOR 0-10V - DIN RAIL > Fan		
General	Fan controller	<input checked="" type="radio"/> standard (1-3 step) <input type="radio"/> 0-10 V
<b>Fan</b>	Number of fan steps	3 steps
Heating/cooling valve	Switch-on threshold for fan step 1	10 %
Auxilliary relay	Switch-on threshold for fan step 2	40 %
E1	Switch-on threshold for fan step 3	70 %
Drip tray monitoring	Fan starting strategy	directly
Set point adjustment	Restart delay (for split-system air conditioners)	no delay (fan / fan coil unit)
Set point values	Minimum time to stay within a fan step	2 min
Regulation	Additional ventilation	no
Operating mode and operation	Warm start	no warm start
	Follow-up time for utilisation of the remaining energy	no follow-up
	Format compulsory control and limitation	<input checked="" type="radio"/> percentage <input type="radio"/> fan step (0 - 3)
	Cyclical transmission of fan step	Format %, don't transmit cyclically

Fig. 4.1 – “Fan” menu with Fan command = standard (1-3 levels)

#### 4.1.1 Number of fan steps

This parameter specifies the number of possible fan levels. The values that can be set are:

- 1 step
- 2 steps
- **3 steps (default value)**

Depending on the number of levels selected, the **Fan Step 1Fan Step 2Fan Step 3** (DPT 1.001 Switch) objects are visualised so the device can signal the set level (the value 1 is sent when the fan is set on the level corresponding to the number indicated by the name of the object).

Depending again on the number of levels, the “**Switch-on threshold for fan step X**” parameters (with X=1..3) are visualised to set the activation thresholds of the various ventilation levels.

**NB:** the gap between two activation thresholds must be **at least 15%**.



### 4.1.2 Switch-on threshold for fan step 1

Determines the control variable that is the starting point for activating ventilation level 1. The values that can be set are:

- 0.4%, 5%, **10%**, 15%, 20%, 25%, 30%, 35%, 40% **default value**

### 4.1.3 Switch-on threshold for fan step 2

Determines the control variable that is the starting point for switching from ventilation level 1 to level 2. The values that can be set are:

- 0%, 10%, 20%, 30%, **40%**, 50%, 60%, 70%, 80%, 90%, 95% **default value**

### 4.1.4 Switch-on threshold for fan step 3

Determines the control variable that is the starting point for switching from ventilation level 2 to level 3. The values that can be set are:

- 0%, 10%, 20%, 30%, 40%, 50%, 60%, **70%**, 80%, 90%, 95% **default value**

### 4.1.5 Fan starting strategy

This parameter is used to set the fan switch-on strategy on the basis of the fan level configured. The values that can be set are:

- **directly** **(default value)**
- above step 1, 5 s
- above step 1, 10 s
- above step 1, 15 s
- above step 1, 20 s
- above step 1, 25 s
- above step 1, 30 s
- above highest step, 5 s
- above highest step, 10 s
- above highest step, 15 s
- above highest step, 20 s
- above highest step, 25 s
- above highest step, 30 s
- above highest step, 40 s
- above highest step, 50 s
- above highest step, 60 s

If **directly** is selected, the fan starts up directly at the configured fan level,

If **above step 1, X s** is selected, the fan always starts up at the lowest level (1) and then switches to the configured level (2 or 3) after a delay of X seconds.



#### 4.1.9 Warm start

The “**Warm start**” parameter can be used to define whether or not to start up the fan as soon as the valve opens, or after a certain configured time (so that cold air is not blown into the room).

The values that can be set are:

- **No warm start**                      **default value**
- 30 s, 1 min, 1 min 30 s, 2 min, 2 min 30 s, 3 min, 3 min 30 s, 4 min, 4 min 30 s, 5 min, 5 min 30 s, 6 min, 6 min 30 s, 7 min, 7 min 30 s

If **No warm start** is selected, the fan starts up as soon as the valve opens.

If a value between 30 seconds and 7 minutes 30 seconds is defined, the valve opens but the fan only starts up after the configured time.

For more information, [refer to par. 19.8.2 “Time between heating and cooling and tail-off time”](#) in annex 2.

#### 4.1.10 Follow up time for utilisation of the remaining energy

When the valve closes, the residual energy in the ventilation device can be exploited, keeping the fan active for a time configured with this parameter.

The values that can be set are:

- **No follow-up**                      **default value**
- 30 s, 1 min, 2 min, 3 min, 4 min, 5 min, 6 min, 7 min, 8 min, 9 min, 10 min, 15 min, 20 min, 30 min
- until valve is closed

If **No follow-up** is selected, the fan is stopped immediately when the regulator value reaches 0.

If a time between **30 s** and **30 min** is defined, the valve closes and then the fan carries on working for the time set, in order to transfer the residual energy from the device to the room.

If **until valve is closed** is selected, the fan carries on working when the regulator value reaches 0% and continues for the valve closure time (heating or cooling).

#### 4.1.11 Format compulsory control and limitation

This parameter is used to configure the format of the objects **Forced fan step**, which can have a percentage value (DPT 5.001 Scaling) or a numerical value representing the ventilation levels 1-2-3 (DPT 5.010 Counter Pulses), and **Limitation of fan step**, which can have a % value (DPT 5.001 Scaling) or a numerical value representing levels 1-2-3 (DPT 5.010 Counter Pulses).

The values that can be set are:

- **percentage**                      **default value**
- fan step (0 – 3)

If **percentage** is selected, both objects will represent a percentage ventilation level, whereas they will both have a numerical ventilation level value of 1-2-3 if **fan step (0 – 3)** is selected.

## 4.1.12 Cyclical transmission of fan step

This parameter defines the format of the **Fan step** object, and the transmission (signalling) method on the BUS. The possible values are:

- Format counter value, don't transmit cyclically
- Format counter value, cycle time 3 min ... 60 min
- **Format %, don't transmit cyclically** **default value**
- Format percentage, cycle time 3 min ... 60 min

If **Format counter value, don't transmit cyclically** is selected, the **Fan step** object has a numerical format DPT 5.010 counter pulses and sends the current fan level with a number between 0 and 3 on change only.

If **Format counter value, cycle time 3 min ... 60 min** is selected, the **Fan step** object has a numerical format DPT 5.010 counter pulses and sends the current fan level both cyclically (with the defined frequency) and on change.

If **Format %, don't transmit cyclically** is selected, the **Fan step** object has a percentage format DPT 5.001 Scaling and sends the configured threshold value for the current level as a percentage value on change only.

If **Format percentage, cycle time 3 min ... 60 min** is selected, the **Fan step** object has a percentage format (DPT 5.001 Scaling) and sends the configured threshold value for the current level as a percentage value, both cyclically (with the defined frequency) and on change. For example:

Thresholds configured:

- Fan level 1 = 10%
- Fan level 2 = 40%
- Fan level 3 = 70%

If fan level 2 is active, object 4 sends the value 40%. The cycle length can be set between 3 and 60 minutes.

## 4.2 Parameters with Fan controller 0-10V

--- KNX FAN COIL ACTUATOR 0-10V - DIN RAIL > Fan

General	Fan controller	<input type="radio"/> standard (1-3 step) <input checked="" type="radio"/> 0-10 V
<b>Fan</b>	Switch ON threshold	10 %
Heating/cooling valve	Restart delay (for split-system air conditioners)	no delay (fan / fan coil unit)
Auxilliary relay	Additional ventilation	no
E1	Warm start	no warm start
Drip tray monitoring	Follow-up time for utilisation of the remaining energy	no follow-up
Set point adjustment	Cyclical transmission of fan object	don't transmit cyclically
Set point values		

Fig. 4.1 – “Fan” menu with Fan command = 0-10V

### 4.2.1 Switch ON threshold

Determines the regulating value that is the starting point for activating the fan. The values that can be set are:

- 0.4%, 5%, **10%**, 15%, 20%, 25%, 30%, 35%, 40% **default value**

### 4.2.2 Restart delay (for split-system air conditioners)

If split air-conditioners are used, it is sometimes necessary to program a standby time (usually indicated by the manufacturer) between a switch-off and the next switch-on. The values that can be set are:

- no delay (fan/fan coil unit)**
- 1 min, 2 min, 3 min, 4 min, 5 min, 6 min, 7 min

If a split air-conditioner is used, respect the standby time (indicated by the manufacturer) between switch-off and switch-on, and set it via this parameter.

### 4.2.3 Additional ventilation

Ventilation can be activated regardless of the control variable for a period specified with this parameter. The possible values are:

- no** **default value**
- every 30 min for 3 min
- every 30 min for 5 min
- every 60 min for 3 min
- every 60 min for 5 min

- permanent ventilation

If **no** is selected, no additional ventilation is activated.

If **every X min for Z min** is selected, the fan is activated for the configured period regardless of the regulating value or control variable.

If **permanent ventilation** is selected, the fan must always work regardless of the regulating value or control variable.

#### 4.2.4 Value for supplementary ventilation

If you want to activate additional ventilation with the previous parameter, this new parameter will appear for setting the required fan speed:

- 0%, 10%, **20%**, 30%, 40%, 50%, 60%, 70%, 80%, 90%, 100% **default value**

#### 4.2.5 Warm start

The “**Warm start**” parameter can be used to define whether or not to start up the fan as soon as the valve opens, or after a certain configured time (so that cold air is not blown into the room).

The values that can be set are:

- **No warm start** **default value**
- 30 s, 1 min, 1 min 30 s, 2 min, 2 min 30 s, 3 min, 3 min 30 s, 4 min, 4 min 30 s, 5 min, 5 min 30 s, 6 min, 6 min 30 s, 7 min, 7 min 30 s

If **No warm start** is selected, the fan starts up as soon as the valve opens.

If a value between 30 seconds and 7 minutes 30 seconds is defined, the valve opens but the fan only starts up after the configured time.

For more information, [refer to par. 19.8.2 “Time between heating and cooling and tail-off time”](#) in annex 2.

#### 4.2.6 Follow up time for utilisation of the remaining energy

When the valve closes, the residual energy in the ventilation device can be exploited, keeping the fan active for a time configured with this parameter.

The values that can be set are:

- **No follow-up** **default value**
- 30 s, 1 min, 2 min, 3 min, 4 min, 5 min, 6 min, 7 min, 8 min, 9 min, 10 min, 15 min, 20 min, 30 min
- until valve is closed

If **No follow-up** is selected, the fan is stopped immediately when the regulator value reaches 0.

If a time between **30 s** and **30 min** is defined, the valve closes and then the fan carries on working for the time set, in order to transfer the residual energy from the device to the room.

If **until valve is closed** is selected, the fan carries on working when the regulator value reaches 0% and continues for the valve closure time (heating or cooling).

#### 4.2.7 Cyclical transmission of fan object

This parameter defines the method for sending the **Fan speed** (DPT 5.001) object that signals the current fan speed and, if the fan is commanded at 0-10V, assumes a percentage format and value.

The possible values are:

- **Don't transmit cyclically**                      **default value**
- Cycle time 3 min...60 min

If **Don't transmit cyclically** is selected, the device sends the fan speed on change only.

If a **Cycle time, 3 minutes .. 60 minutes** is selected, the device sends the fan speed cyclically (with the frequency defined) and on change.

## 5 “Heating valve” menu

The **Heating valve menu**, visible if the supported function is “**Heating**”, contains the parameters for configuring the operation of the valve itself.

The menu appears as shown in the figure below:

-.- KNX FAN COIL ACTUATOR 0-10V - DIN RAIL > Heating valve		
General	Time for the valve to close	3 min
Fan	New position at change of	5 %
<b>Heating valve</b>	Open for actuating value above	0,4 %
Auxilliary relay	Minimum valve position	0 %
E1	Maximum valve position above	50 %
E2	Maximum valve position	100 %
	Cyclical transmission of heating status	don't transmit cyclically

Fig. 5.1 – “Heating valve” menu

### 5.1 Parameters

#### 5.1.1 Time for the valve to close

This parameter can be used to regulate a heating valve closure time, preventing the cooling valve from opening too soon. The possible values are:

- 0 min, 1 min, 2 min, **3 min**, 4 min, 5 min, 6 min, 7 min, 8 min, 9 min, 10 min, 15 min, 20 min, 30 min

#### 5.1.2 New position at change of

The “**New position at change of**” parameter is used to specify when the valve is repositioned in relation to the change in the control variable. The values that can be set are:

- Always set valve exactly
- 1%, 2%, ..., **5%**, ..., 15%      **default value**

If **Always set valve exactly** is selected, the valve is repositioned with every change in the control variable.

If a percentage value between **1% and 15%** is defined, the valve is always repositioned only when the control variable changes (in relation to the last positioning) by a value greater than the set value. This prevents any unnecessary minimum repositioning.



### 5.1.3 Open for actuating value above

With this parameter, you can decide whether the valve should open immediately with the minimum value assumed by the control variable (0.4%), or only when the control variable has reached the set value. The possible values are:

- **0.4%**                      **default value**
- 5%, 10%, 15%, 20%, 25%, 30%, 35%, 40%

If **0.4%** is selected, the valve opens with the minimum control variable value.

If a value between **5% and 40%** is defined, the valve is only opened when the control variable reaches the set value. This setting prevents any whistling effect from a slightly open valve.

This parameter affects the definition of the characteristic valve curve. For more information, refer to par. 19.2 [Setting the characteristic valve curve](#) in annex 2.

### 5.1.4 Minimum valve position

This specifies the minimum permitted valve position in the face of a variation of the specified control variable from this percentage. The possible values are:

- **0%**, 5%, 10%, 15%, 20%, 25%, 30%, 35%, 40%, 45%, 50%                      **default value**

This parameter affects the definition of the characteristic valve curve. For more information, refer to par. 19.2 [Setting the characteristic valve curve](#) in annex 2.

### 5.1.5 Maximum valve position above

This parameter is used to set the positioning of the valve in its maximum position, starting from the value (%) assumed by the specified control variable. The possible values are:

- 0.4%, 10%, 20%, 30%, 40%, **50%**, 60%, 70%, 80%, 90%, 100%                      **default value**

This parameter affects the definition of the characteristic valve curve. For more information, refer to par. 19.2 [Setting the characteristic valve curve](#) in annex 2.

### 5.1.6 Maximum valve position

This specifies the maximum permitted valve position. The possible values are:

- 55%, 60%, 65%, 70%, 75%, 80%, 85%, 90%, 95%, **100%**                      **default value**

This parameter affects the definition of the characteristic valve curve. For more information, refer to par. 19.2 [Setting the characteristic valve curve](#) in annex 2.

### 5.1.7 Delay between heating and cooling

If the “Supported functions” in the **General** menu is “Heating and Cooling”, this parameter will be visualised in order to set a delay in the switch from heating to cooling after the complete closure of the heating valve. The cooling valve can only be opened at the end of this time. The possible values are:

- **0 min**, 1 min, 2 min, 3 min, 4 min, 5 min, 6 min, 7 min, 8 min, 9 min, 10 min, 15 min, 20 min, 30 min

For more information, [refer to par. 19.8.2 “Time between heating and cooling and tail-off time”](#) in annex 2.

### 5.1.8 Cyclical transmission of heating status

This parameter is used to set the cyclical transmission of the **Heating status** (DPT 1.001) object on the BUS. The possible values are:

- | • <b>Don't transmit cyclically</b> | <b>default value</b> |
|------------------------------------|----------------------|
| • 3 min                            |                      |
| • 5 min                            |                      |
| • 10 min                           |                      |
| • 15 min                           |                      |
| • 20 min                           |                      |
| • 30 min                           |                      |
| • 60 min                           |                      |

## 6 “Cooling valve” menu

The **Cooling valve** menu, visible if the supported function is **Cooling**, contains the parameters for configuring the operation of the valve itself.

The menu appears as shown in the figure below:

--- KNX FAN COIL ACTUATOR 0-10V - DIN RAIL > Cooling valve		
General	Time for the valve to close	3 min
Fan	New position at change of	5 %
Heating valve	Open for actuating value above	0,4 %
<b>Cooling valve</b>	Minimum valve position	0 %
	Maximum valve position above	50 %
Auxilliary relay	Maximum valve position	100 %
E1	Cyclical transmission of cooling status every	don't transmit cyclically

Fig. 6.1 – “Cooling valve” menu

### 6.1 Parameters

#### 6.1.1 Time for the valve to close

This parameter can be used to regulate a cooling valve closure time, preventing the heating valve from opening too soon. The possible values are:

- 0 min, 1 min, 2 min, **3 min**, 4 min, 5 min, 6 min, 7 min, 8 min, 9 min, 10 min, 15 min, 20 min, 30 min

#### 6.1.2 New position at change of

The “**New position at change of**” parameter is used to specify when the valve is repositioned in relation to the change in the control variable. The values that can be set are:

- Always set valve exactly
- 1%, 2%, ..., **5%**, ..., 15% **default value**

If **Always set valve exactly** is selected, the valve is repositioned with every change in the control variable.

If a percentage value between **1% and 15%** is defined, the valve is always repositioned only when the control variable changes (in relation to the last positioning) by a value greater than the set value. This prevents any unnecessary minimum repositioning.

### 6.1.3 Open for actuating value above

With this parameter, you can decide whether the valve should open immediately with the minimum value assumed by the control variable (0.4%), or only when the control variable has reached the set value. The possible values are:

- **0.4%**                      **default value**
- 5%, 10%, 15%, 20%, 25%, 30%, 35%, 40%

If **0.4%** is selected, the valve opens with the minimum control variable value.

If a value between **5% and 40%** is defined, the valve is only opened when the control variable reaches the set value. This setting prevents any whistling effect from a slightly open valve.

This parameter affects the definition of the characteristic valve curve. For more information, refer to par. 19.2 [Setting the characteristic valve curve](#) in annex 2.

### 6.1.4 Minimum valve position

This specifies the minimum permitted valve position in the face of a variation of the specified control variable from this percentage. The possible values are:

- **0%**, 5%, 10%, 15%, 20%, 25%, 30%, 35%, 40%, 45%, 50%                      **default value**

This parameter affects the definition of the characteristic valve curve. For more information, refer to par. 19.2 [Setting the characteristic valve curve](#) in annex 2.

### 6.1.5 Maximum valve position above

This parameter is used to set the positioning of the valve in its maximum position, starting from the value (%) assumed by the specified control variable. The possible values are:

- 0.4%, 10%, 20%, 30%, 40%, **50%**, 60%, 70%, 80%, 90%, 100%                      **default value**

This parameter affects the definition of the characteristic valve curve. For more information, refer to par. 19.2 [Setting the characteristic valve curve](#) in annex 2.

### 6.1.6 Maximum valve position

This specifies the maximum permitted valve position. The possible values are:

- 55%, 60%, 65%, 70%, 75%, 80%, 85%, 90%, 95%, **100%**                      **default value**

This parameter affects the definition of the characteristic valve curve. For more information, refer to par. 19.2 [Setting the characteristic valve curve](#) in annex 2.

## 6.1.7 Cyclical transmission of cooling status every

This parameter is used to set the cyclical transmission of the **Cooling status** (DPT 1.001) object on the BUS. The possible values are:

- **Don't transmit cyclically**                      **default value**
- 3 min
- 5 min
- 10 min
- 15 min
- 20 min
- 30 min
- 60 min

## 7 “Heating/cooling valve” menu

The **Heating/Cooling valve** menu (which only appears if, in the **General** menu, the **Heating/Cooling** function was selected and “**Kind of installation**” is set at **2-pipe system**) contains the parameters for configuring valve operation on the basis of the type of valve.

--.- KNX FAN COIL ACTUATOR 0-10V - DIN RAIL > Heating/cooling valve		
General	Time for the valve to close	3 min
Fan	New position at change of	5 %
<b>Heating/cooling valve</b>	Open for actuating value above	0,4 %
Auxilliary relay	Minimum valve position	0 %
E1	Maximum valve position above	50 %
Drip tray monitoring	Maximum valve position	100 %
	Cyclical transmission of heating/cooling status	don't transmit cyclically

Fig. 7.1 – “Heating/Cooling valve” menu

### 7.1 Parameters

#### 7.1.1 Time for the valve to close

This parameter is used to set a valve closure time on the basis of the actuator used. The possible values are:

- 0 min, 1 min, 2 min, **3 min**, 4 min, 5 min, 6 min, 7 min, 8 min, 9 min, 10 min, 15 min, 20 min, 30 min

#### 7.1.2 New position at change of

The “**New position at change of**” parameter is used to specify when the valve is repositioned in relation to the change in the control variable. The values that can be set are:

- Always set valve exactly
- 1%, 2%, ..., **5%**, ..., 15%      **default value**

If **Always set valve exactly** is selected, the valve is repositioned with every change in the control variable.

If a percentage value between **1% and 15%** is defined, the valve is always repositioned only when the control variable changes (in relation to the last positioning) by a value greater than the set value. This avoids frequent but minor positioning variations.

### 7.1.3 Open for actuating value above

With this parameter, you can decide whether the valve should open immediately with the minimum value assumed by the control variable (0.4%), or only when the control variable has reached the set value. The possible values are:

- **0.4%**                      **default value**
- 5%, 10%, 15%, 20%, 25%, 30%, 35%, 40%

If **0.4%** is selected, the valve opens with the minimum control variable value.

If a value between **5% and 40%** is defined, the valve is only opened when the control variable reaches the set value. This setting prevents any whistling effect from a slightly open valve.

This parameter affects the definition of the characteristic valve curve. For more information, refer to par. 19.2 [Setting the characteristic valve curve](#) in annex 2.

### 7.1.4 Minimum valve position

This specifies the minimum permitted valve position in the face of a variation of the specified control variable from this percentage. The possible values are:

- **0%**, 5%, 10%, 15%, 20%, 25%, 30%, 35%, 40%, 45%, 50%                      **default value**

This parameter affects the definition of the characteristic valve curve. For more information, refer to par. 19.2 [Setting the characteristic valve curve](#) in annex 2.

### 7.1.5 Maximum valve position above

This parameter is used to set the positioning of the valve in its maximum position, starting from the value (%) assumed by the specified control variable. The possible values are:

- 0.4%, 10%, 20%, 30%, 40%, **50%**, 60%, 70%, 80%, 90%, 100%                      **default value**

This parameter affects the definition of the characteristic valve curve. For more information, refer to par. 19.2 [Setting the characteristic valve curve](#) in annex 2.

### 7.1.6 Maximum valve position

This specifies the maximum permitted valve position. The possible values are:

- 55%, 60%, 65%, 70%, 75%, 80%, 85%, 90%, 95%, **100%**                      **default value**

This parameter affects the definition of the characteristic valve curve. For more information, refer to par. 19.2 [Setting the characteristic valve curve](#) in annex 2.

### 7.1.7 Cyclical transmission of heating/cooling status

This parameter is used to set the cyclical transmission of the *Heating status* (DPT 1.001) and *Cooling status* (DPT 1.001) objects on the BUS. The possible values are:

- **Don't transmit cyclically**                      **default value**
- 3 min
- 5 min
- 10 min
- 15 min
- 20 min
- 30 min
- 60 min



## 8 “Auxiliary relay” menu

The **Auxiliary relay** menu contains the parameters for configuring the behaviour of the additional relay on the device. The menu is as follows:

--.- KNX FAN COIL ACTUATOR 0-10V - DIN RAIL > Auxilliary relay		
General	Switch ON auxiliary relay	if heating is required
Fan	Cyclical transmission of aux. relay status every	don't transmit cyclically
Heating/cooling valve		
Auxilliary relay		

Fig. 8.1 – “Additional relay” menu

### 8.1 Parameters

#### 8.1.1 Switch ON auxiliary relay

The “**Switch ON auxiliary relay**” parameter is used to define whether the relay output should be commanded via the BUS, on the dedicated **Auxiliary relay** (DPT 1.001 Switch) object (on the basis of the control variable in heating or cooling) or activated when the heating or cooling valve opens. The values that can be set are:

- **via object** (default value)
- if heating is required
- if cooling is required
- together with heating valve
- together with cooling valve

If **via object** is selected the additional relay will only be commanded externally via the BUS on the **Auxiliary relay** (DPT 1.001 Switch) object (entirely free of the HVAC control of the fan coil actuator), using the relay output as a general binary output to command a circuit via a push-button, sensor or other command device connected to the BUS. With this setting, the relay status is not transmitted.

If **if heating is required** is selected, the additional relay is activated as soon as the heating control variable is higher than 0%. Relay switching can be notified via the **Auxiliary relay status** (DPT 1.001 Switch) object, and the “**Cyclical transmission of aux. relay status every**” parameter allows you to set the cyclical transmission of the status object.

If **if cooling is required** is selected, the additional relay is activated as soon as the cooling control variable is higher than 0%. Relay switching can be notified via the **Auxiliary relay status** (DPT 1.001 Switch) object, and the “**Cyclical transmission of aux. relay status every**” parameter allows you to set the cyclical transmission of the status object.

If **together with heating valve** is selected, the additional relay is only activated when the heating valve is effectively opened (with the characteristic valve curve adapted, the valve can remain closed with a limited control variable). Relay switching can be notified via the **Auxiliary relay status** (DPT 1.001 Switch) object, and the “**Cyclical transmission of aux. relay status every**” parameter allows you to set the cyclical transmission of the status object.

If **together with cooling valve** is selected, the additional relay is only activated when the cooling valve is effectively opened (with the characteristic valve curve adapted, the valve can remain closed with a limited control variable). Relay switching can be notified via the **Auxiliary relay status** (DPT 1.001 Switch) object, and the **“Cyclical transmission of aux. relay status every”** parameter allows you to set the cyclical transmission of the status object.

### 8.1.2 Cyclical transmission of aux. relay status every

This parameter is used to set a cyclical transmission time for the status of the additional relay. The values that can be set are:

- **Don't transmit cyclically**                      **default value**
- 3 min
- 5 min
- 10 min
- 15 min
- 20 min
- 30 min
- 60 min

## 9 “E1” menu

The **E1** menu contains the parameters for configuring the E1 input that can be used for a window contact or an external temperature sensor (e.g. GWA9145).  
The menu changes on the basis of this setting.

### 9.1 Parameters with Function of E1 = window contact

Fig. 9.1 – “E1” menu with Function of E1 = Window contact

#### 9.1.1 Function of E1

The “**Function of E1**” parameter is used to define whether a window contact or a temperature sensor is connected to the E1 input. The values that can be set are:

- **E1 = window contact (default value)**
- E1 = actual value sensor

If **window contact** is set, the “**Direction of operation of window contact**” and “**Cyclical transmission of window contact**” parameters are visualised to set the type of window contact (open or closed contact) and the transmission method for the status object **Status of window contact at E1** (DPT 1.019 window/door).

#### 9.1.2 Direction of operation of window contact

Specifies the type of contact connected (opening or closure contact). The possible values are:

- **Contact closed = window closed (default value)**
- Contact open = window closed

#### 9.1.3 Cyclical transmission of window contact

This parameter specifies the cyclical transmission time for the window contact status object **Status window contact at E1** (DPT 1.019 window/door). The possible values are:

- **Don't transmit cyclically** (default value)
- 3 min, 5 min, 10 min, 15 min, 20 min, 30 min, 60 min

## 9.2 Parameters with Function of E1 = actual value sensor

--- KNX FAN COIL ACTUATOR 0-10V - DIN RAIL > E1

General	Function of E1	<input type="radio"/> E1 = window contact <input checked="" type="radio"/> E1 = actual value sensor
Fan	Actual value offset in 0.1 K (-50..50)	0
Heating/cooling valve	Transmission of actual value at change of	every 0,5 K
Auxilliary relay	Cyclical transmission of actual value	don't transmit cyclically

**E1**

Fig. 9.2 – “E1” menu with Function of E1 = Actual value sensor

### 9.2.1 Actual value offset in 0.1 K

With this parameter, you can enter a positive or negative correction for the temperature measured by the sensor connected to input E1, in steps of 1/10 K. The possible value is:

- Manual setting from -50 to +50 (default value = 0)

#### Examples:

a) The device sends 20.3°C.

A calibrated thermostat measures an ambient temperature of 21.0°C. To increase the temperature of the fan coil actuator to 21°C, you must set "7" (i.e. 7 x 0.1 K).

b) The device sends 21.3°C. The temperature measured is 20.5°C. To reduce the temperature sent to 20.5°C, set "-8" (i.e. -8 x 0.1 K).

### 9.2.2 Transmission of actual value at change of

If you want to send the current ambient temperature, use this parameter to set transmission upon the variation indicated by this value (or only cyclically; the temperature will be sent via the **Actual value from E1** (DPT 9.001 temperature) object). The possible values are:

- Not due to a change
- Every 0,2 K
- Every 0,3 K
- **Every 0,5 K** (default value)
- Every 1 K

### 9.2.3 Cyclical transmission of actual value

This parameter can be used to set a frequency for the cyclical sending of the temperature measured by the sensor via the **Actual value from E1** (DPT 9.001 temperature) object, regardless of the temperature variation. The possible values are:

- **Don't transmit cyclically**
- 3 min, 5 min, 10 min, 15 min, 20 min, 30 min, 60 min

**NB:** when setting this parameter and the previous one, check the effect of the resulting load on the BUS traffic.

## 10 “E2” menu

The **E2** menu is only visible if the “**Supported functions**” specified in the **General** menu is **Heating**. In this case, input E2 can be used to connect a window contact (if, for example, a temperature sensor is connected on E1) and the following parameters will appear.

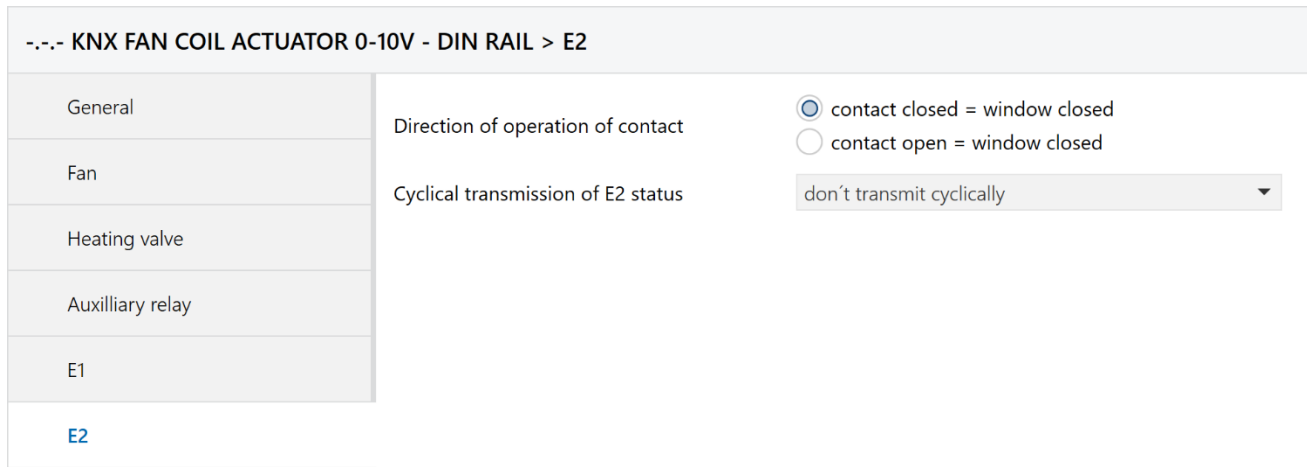

Fig. 10.1 – “E2” menu with Supported function = Heating

### 10.1 Parameters

#### 10.1.1 Direction of operation of contact

Specifies the type of contact connected (opening or closure contact). The possible values are:

- **Contact closed = window closed** (default value)
- Contact open = window closed

#### 10.1.2 Cyclical transmission of E2 status

This parameter specifies the cyclical transmission time for the window contact status object **Status of window contact at E2** (DPT 1.019 window/door). The possible values are:

- **Don't transmit cyclically** default value
- 3 min, 5 min, 10 min, 15 min, 20 min, 30 min, 60 min

## 11 “Drip tray monitoring” menu

The **Drip tray monitoring** menu is only visible if the **Supported functions** specified in the **General** menu is **Cooling** or **Heating/Cooling**.

--- KNX FAN COIL ACTUATOR 0-10V - DIN RAIL > Drip tray monitoring

General	Source for drip tray monitoring	<input checked="" type="radio"/> E2 <input type="radio"/> object 16
Fan	Direction of operation of contact	<input checked="" type="radio"/> contact closed = condensate <input type="radio"/> contact open = condensate
Cooling valve	Behaviour in case of drip tray alarm	cooling and fan OFF ▼
Auxilliary relay	Cyclical transmission of alarm status	don't transmit cyclically ▼
E1		
<b>Drip tray monitoring</b>		
Set point adjustment		

Fig. 11.1 – “Drip tray monitoring” menu with Supported Function = Cooling or Heating/Cooling

### 11.1 Parameters

#### 11.1.1 Source of drip tray monitoring

Specifies whether the drip tray monitoring is carried out via input E2 or via the BUS, on object 16 **Drip tray monitoring status** (DPT 1.001 Switch). The possible values are:

- **E2 (default value)**
- object 16

If **E2** is selected, the drip tray is monitored via the contact on input E2 and signalled on the BUS via the output object **Drip tray monitoring status** (DPT 1.001 Switch).

If **Object 16** is selected, the drip tray is monitored via an external sensor and received from the device via the BUS on the **Drip tray monitoring status** (DPT 1.001 Switch) object.

#### 11.1.2 Direction of operation of contact

Specifies the type of drip tray signalling contact connected to input E2 or the drip tray status telegram received from the BUS. The possible values are:

- **Contact closed = Condensate (default value)**
- Contact open = Condensate

### 11.1.3 Behaviour in case of drip tray alarm

Used to specify what the device must do when a drip tray alarm is triggered. The possible values are:

- **Cooling and fan OFF (default value)**
- Cooling OFF and min. speed
- Cooling OFF and max. speed
- Only report

### 11.1.4 Cyclical transmission of alarm status

If the **Source for drip tray monitoring** is input **E2**, this parameter will be visualised to specify the cyclical transmission time for the ***Drip tray monitoring status*** (DPT 1.001 Switch) status object. The possible values are:

- **Don't transmit cyclically** **default value**
- 3 min, 5 min, 10 min, 15 min, 20 min, 30 min, 60 min



## 12 “Set point adjustment” menu

The **Set point adjustment** menu is only visible if the **Supported functions** specified in the **General** menu is **Cooling** or **Heating/Cooling**.

The adjustment of the programmed (nominal) value dynamically adapts the nominal value to the outdoor temperature in cooling mode. If the outdoor temperature exceeds a defined threshold, the adjustment is activated and the corresponding increase of the nominal value is established.

The programmed value adjustment should avoid an excessive indoor and outdoor temperature difference in the summer. The programmed value indicated in Cooling mode can therefore be automatically increased in proportion to the increase in the outdoor temperature.

[Refer to the annex: programmed value adjustment.](#)

--.- KNX FAN COIL ACTUATOR 0-10V - DIN RAIL > Set point adjustment		
General	Set point adjustment from	25 °C ▼
Fan	Adjustment	1 K per 3 K outdoor temperature ▼
Cooling valve	Format of the adjustment value	<input checked="" type="radio"/> relative <input type="radio"/> absolute
Auxilliary relay	Cyclical transmission of set point adjustment	don't transmit cyclically ▼
E1		
Drip tray monitoring		
<a href="#">Set point adjustment</a>		

Fig. 12.1 – “Set point adjustment” menu with Supported Function = Cooling or Heating/Cooling

### 12.1 Parameters

#### 12.1.1 Set point adjustment from

Specifies the activation threshold for the correction of the nominal programmed value. The possible values are:

- 25°C, 26°C, 27°C, 28°C, 29°C, 30°C....., 38°C, 39°C, 40°C **(default value)**

#### 12.1.2 Adjustment

With this parameter, you can specify the intensity of the nominal correction - i.e. which outdoor temperature modification the nominal value (1 K) must be corrected for. The possible values are:

- none
- 1 K per 1 K outdoor temperature
- 1 K per 2 K outdoor temperature
- **1 K per 3 K outdoor temperature** **(default value)**
- 1 K per 4 K outdoor temperature

- 1 K per 5 K outdoor temperature
- 1 K per 6 K outdoor temperature
- 1 K per 7 K outdoor temperature

### 12.1.3 Format of the adjustment value

With this parameter, you can specify the format for the **Adjust set point** object used to send the nominal value adjustment message to other thermostats, probes or other devices involved in HVAC control and connected to the system. The possible values are:

- **relative** (default value)
- absolute

If **relative** is selected, the device uses the **Adjust set point** (DPT 9.002 temperature difference – K) object to send a temperature difference in K on the basis of the outdoor temperature. This value can be used as an adjustment in the nominal value for other ambient thermostats.

Example:

Standard nominal value without correction = 20°C. Nominal value correction = +2 K

The object sends: 2 K(\*).

If **absolute** is selected, the device uses the **Adjust set point** (DPT 9.001 temperature – °C) object to send a nominal value in °C given by the standard nominal value without correction + the nominal value correction, as the nominal value for other thermostats.

Example:

Standard nominal value without correction = 20°C. Nominal value correction = +2 K

The object sends: 22°C\*

(\*) Important: when the “**Use set point adjustment for regulation**” parameter is set on “**yes**”, the nominal value for the internal regulator is also adjusted.

In our example, this is increased in both cases by 2 K.

### 12.1.4 Base set point without adjustment

If the “**Format of the adjustment value**” is **absolute**, this parameter can be used to specify the standard nominal value that can be used by other thermostats. The possible values are:

- 15°C, 16°C, 17°C, 18°C, 19°C, 20°C, **21°C**, 22°C, 23°C, 24°C, 25°C, 26°C, 27°C, 28°C, 29°C, 30°C

**Important:** this value should coincide with the standard nominal value of the thermostats commanded.

### 12.1.5 Cyclical transmission of set point adjustment

This parameter specifies the cyclical transmission time for the nominal value correction via the **Adjust set point** object. The possible values are:

- **Don't transmit cyclically** default value
- 3 min, 5 min, 10 min, 15 min, 20 min, 30 min, 60 min

## 12.1.6 Use set point adjustment for regulation

This parameter, visible if the “**Kind of used controller**” is **Internal controller with temp. sensor at E1**, defines whether or not the nominal value adjustment should affect the internal regulator. The possible values are:

- **no**                    **default value**
- **yes**

If you select **no**, the adjustment of the nominal value has no effect on the built-in regulator

If you select **yes** the standard nominal value for the adjustment (= *Standard nominal value after reset + Dead zone*) must be gradually regulated on the basis of the outdoor temperature.

## 13 “Set point values” menu

The **Set point adjustment** menu is only visible if the “**Kind of used controller**” specified in the **General** menu is **Internal controller with temp. sensor at E1**.

The parameters in this menu vary depending on the **Supported functions** (Heating, Cooling, or Heating/Cooling).

### 13.1 Parameters with the supported function Heating

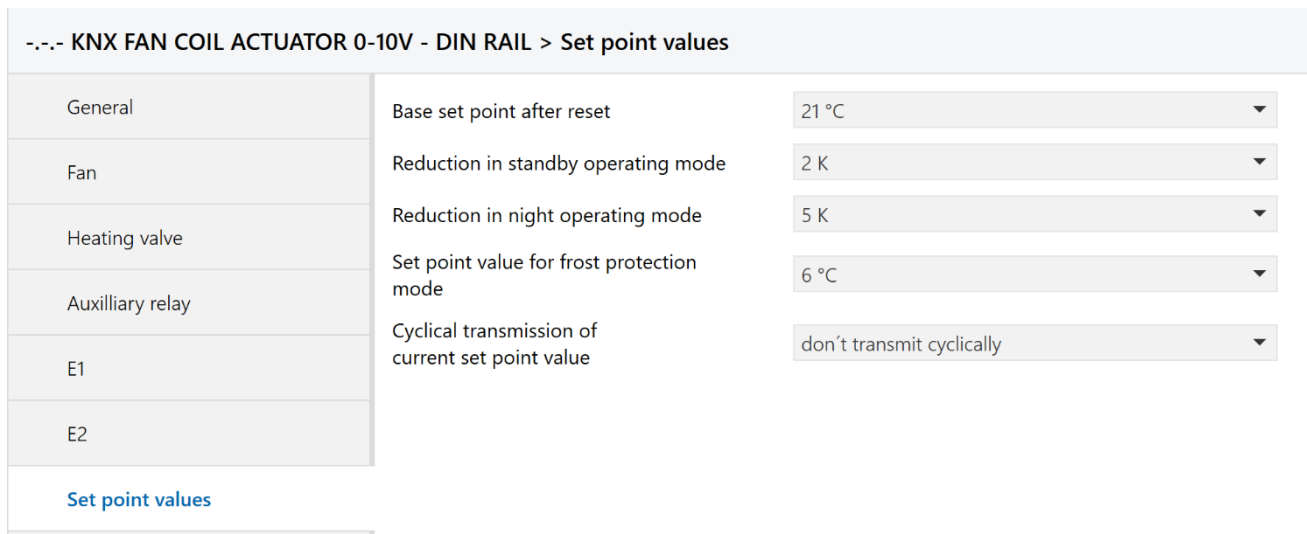

--- KNX FAN COIL ACTUATOR 0-10V - DIN RAIL > Set point values		
General	Base set point after reset	21 °C
Fan	Reduction in standby operating mode	2 K
Heating valve	Reduction in night operating mode	5 K
Auxilliary relay	Set point value for frost protection mode	6 °C
E1	Cyclical transmission of current set point value	don't transmit cyclically
E2		
<a href="#">Set point values</a>		

Fig. 13.1 – “Set point values” menu with Supported Function = Heating

#### 13.1.1 Base set point after reset

Specifies the nominal value assigned for temperature regulation. The possible values are:

- 15°C, 16°C, 17°C, ..., **21°C**,..., 29°C, 30°C **(default value)**

#### 13.1.2 Reduction in standby operating mode

Specifies how much the temperature must be reduced in Standby mode during heating. The possible values are:

- 0.5 K, 1 K, 1.5 K, **2 K**, 2.5 K, 3 K, 3.5 K, 4 K **(default value)**

#### 13.1.3 Reduction in night operating mode

Specifies how much the temperature must be reduced in Night mode during heating. The possible values are:

- 3 K, 4 K, **5 K**, 6 K, 7 K, 8 K **(default value)**

### 13.1.4 Set point value for frost protection mode

Specifies the nominal value assigned for Frost Protection mode during heating. The possible values are:

- 3°C, 4°C, 5°C, **6°C**, 7°C, 8°C, 9°C, 10°C **(default value)**

### 13.1.5 Cyclical transmission of set point value

Used to specify the cyclical transmission time for the active nominal value via the **Current setpoint value** (DPT 9.001 temperature) object. The possible values are:

- **Don't transmit cyclically** **default value**
- 3 min, 5 min, 10 min, 15 min, 20 min, 30 min, 60 min

## 13.2 Parameters with the supported function Cooling

--- KNX FAN COIL ACTUATOR 0-10V - DIN RAIL > Set point values		
General	Base set point after reset	21 °C ▼
Fan	Increasing in standby mode	2 K ▼
Cooling valve	Increasing in night mode	5 K ▼
Auxilliary relay	Set point value for heat protection	42 °C (= no heat protection) ▼
E1	Cyclical transmission of current set point value	don't transmit cyclically ▼
Drip tray monitoring		
Set point adjustment		
<a href="#">Set point values</a>		

Fig. 13.2 – “Set point values” menu with Supported Function = Cooling

### 13.2.1 Base set point after reset

Specifies the nominal value assigned for temperature regulation. The possible values are:

- 15°C, 16°C, 17°C, ..., **21°C**, ..., 29°C, 30°C **(default value)**

### 13.2.2 Increasing in standby mode

Specifies how much the temperature must be increased in Standby mode during cooling. The possible values are:

- 0.5 K, 1 K, 1.5 K, **2 K**, 2.5 K, 3 K, 3.5 K, 4 K **(default value)**

### 13.2.3 Increasing in night mode

Specifies how much the temperature must be increased in Night mode during cooling. The possible values are:

- 3 K, 4 K, **5 K**, 6 K, 7 K, 8 K      **(default value)**

### 13.2.4 Set point value for heat protection

Specifies the nominal value assigned for Heat Protection mode (overtemperature) during cooling. Heat Protection is the max. permitted temperature for the room in question. During cooling, it fulfils the same role as Frost Protection during heating - i.e. it saves energy and at the same time prevents unpermitted temperatures. The possible values are:

- **42°C** (= no heat protection)      **(default value)**
- 29°C
- 30°C
- 31°C
- 32°C
- 33°C
- 34°C
- 35°C

### 13.2.5 Cyclical transmission of current set point value

Used to specify the cyclical transmission time for the active nominal value via the **Current setpoint value** (DPT 9.001 temperature) object. The possible values are:

- **Don't transmit cyclically**      **default value**
- 3 min, 5 min, 10 min, 15 min, 20 min, 30 min, 60 min

## 13.3 Parameters with the supported function Heating/Cooling

-.- KNX FAN COIL ACTUATOR 0-10V - DIN RAIL > Set point values		
General	Base set point after reset	21 °C
Fan	Reduction in standby operating mode at heating	2 K
Heating/cooling valve	Reduction in night operating mode at heating	5 K
Auxilliary relay	Set point value for frost protection (at heating)	6 °C
E1	Dead zone between heating and cooling	2 K
Drip tray monitoring	Increasing in standby mode at cooling	2 K
Set point adjustment	Increasing in night mode at cooling	5 K
<b>Set point values</b>	Set point value for heat protection (at cooling)	42 °C (= no heat protection)
Regulation	Current set point value in comfort mode	<input checked="" type="radio"/> transmit actual temp. setpoint (heating<>cooling) <input type="radio"/> transmit mean value heating/cooling setpoints
Operating mode and operation	Cyclical transmission of current set point value	don't transmit cyclically

Fig. 13.3 – “Set point values” menu with Supported Function = Heating/Cooling

### 13.3.1 Base set point after reset

Specifies the nominal value assigned for temperature regulation. The possible values are:

- 15°C, 16°C, 17°C, ..., **21°C**,..., 29°C, 30°C **(default value)**

### 13.3.2 Reduction in standby operating mode at heating

Specifies how much the temperature must be reduced in Standby mode during heating. The possible values are:

- 0.5 K, 1 K, 1.5 K, **2 K**, 2.5 K, 3 K, 3.5 K, 4 K **(default value)**

### 13.3.3 Reduction in night operating mode at heating

Specifies how much the temperature must be reduced in Night mode during heating. The possible values are:

- 3 K, 4 K, **5 K**, 6 K, 7 K, 8 K **(default value)**

### 13.3.4 Set point value for frost protection (at heating)

Specifies the nominal value assigned for Frost Protection mode during heating. The possible values are:

- 3°C, 4°C, 5°C, **6°C**, 7°C, 8°C, 9°C, 10°C (default value)

### 13.3.5 Dead zone between heating and cooling

Determines the transit area between the programmed values for Heating mode and Cooling mode (refer to [par. 19.6 in Annex 2 - Dead zone](#)).

The possible values are:

- 1 K, **2 K**, 3 K, 4 K, 5 K, 6 K (default value)

### 13.3.6 Increasing in standby mode at cooling

Specifies how much the temperature must be increased in Standby mode during cooling. The possible values are:

- 0.5 K, 1 K, 1.5 K, **2 K**, 2.5 K, 3 K, 3.5 K, 4 K (default value)

### 13.3.7 Increasing in night mode at cooling

Specifies how much the temperature must be increased in Night mode during cooling. The possible values are:

- 3 K, 4 K, **5 K**, 6 K, 7 K, 8 K (default value)

### 13.3.8 Set point value for heat protection (at cooling)

Specifies the nominal value assigned for Heat Protection mode (overtemperature) during cooling. Heat Protection is the max. permitted temperature for the room in question. During cooling, it fulfils the same role as Frost Protection during heating - i.e. it saves energy and at the same time prevents unpermitted temperatures. The possible values are:

- **42°C** (i.e. almost no Heat Protection) (default value)
- 29°C
- 30°C
- 31°C
- 32°C
- 33°C
- 34°C
- 35°C

### 13.3.9 Current set point value in comfort mode

This parameter is used to define which nominal value must be active in Comfort mode. The possible values are:

- **Transmit actual temp. (Heating <> Cooling)** (default value)
- Transmit mean value Heating/Cooling setpoints



If you select **Transmit actual temp. (Heating <> Cooling)**, the nominal value for making the true regulation (= active nominal value) is always sent.

Example:

with a standard nominal value of 21°C and a [dead zone](#) of 2 K: the value 21°C is sent during heating, whereas the standard nominal value + dead zone (21°C + 2 K = 23°C) is sent during cooling

If you select **Transmit mean value Heating/Cooling setpoints**, in Comfort mode the same value will be sent for both heating and cooling: standard nominal value + half the dead zone.  
In this way, the people in the room are not disturbed.

Example:

with a standard nominal value of 21°C and a dead zone of 2 K: average value = 21°C + 1 K = 22°C.  
The regulation, however, is made with 21°C in heating and 23°C in cooling.

### 13.3.10 Cyclical transmission of current set point value

Used to specify the cyclical transmission time for the active nominal value via the **Current set point value** (DPT 9.001 temperature) object. The possible values are:

- **Don't transmit cyclically**                      **default value**
- 3 min, 5 min, 10 min, 15 min, 20 min, 30 min, 60 min

## 14 “Regulation” menu

The **Regulation** menu is only visible if the “**Kind of used controller**” specified in the **General** menu is **Internal controller with temp. sensor at E1**.

The parameters in this menu vary depending on the **Supported function** (Heating, Cooling, or Heating/Cooling).

### 14.1 Parameters with the supported function Heating

-.- KNX FAN COIL ACTUATOR 0-10V - DIN RAIL > Regulation		
General	Proportional band of heating controller	2 K
Fan	Setting of control parameters	<input type="radio"/> standard <input checked="" type="radio"/> user defined
Heating valve	Integral action time constant of heating controller	150 min
Auxilliary relay	Transmission of actuating value	at change of 5 %
E1	Cyclical transmission of actuating value every	15 min
E2	Report, when heating required but heating disabled	<input checked="" type="radio"/> only if object value = 1 <input type="radio"/> always cyclically
Set point values	Report cyclically	every 30 min

**Regulation**

Fig. 14.1 – “Regulation” menu with Supported function = Heating

#### 14.1.1 Setting of control parameters

This parameter specifies whether to leave the standard setting for the regulation parameters, or personalise them. The possible values are:

- **Standard** (default value)
- User defined

If **user defined** is selected, the regulation parameters can be individually set, so the following parameters will appear: “**Proportional band of heating controller.**” and “**Integral action time constant of heating controller**”.

#### 14.1.2 Proportional band of heating controller

Professional setting for adapting the regulation behaviour to the room.

Small values make big changes to the control variable, whereas large values make a more limited change. The possible values are (**standard value=4 K**):

- 1 K, 1.5 K, 2 K, 2.5 K, 3 K, 3.5 K, **4 K**, 4.5 K, 5 K, 5.5 K, 6 K, 6.5 K, 7 K, 7.5 K, 8 K, 8.5 K

### 14.1.3 Integral action time constant of heating controller

Setting of the regulator integration time, selected as a pure proportional regulator, or setting of an integration time (for PI regulator only). The possible values are:

- Only proportional controller
- 15 min, 30 min, 45 min, 60 min, 75 min, **90 min**, 105 min, 120 min, 135 min, 150 min, 165 min, 180 min, 195 min, 210 min, 225 min.

For more information, refer to [par. 19.9 Regulating the temperature in Annex 2](#).

### 14.1.4 Transmission of actuating value

This parameter can be used to define the % variation of the control variable after which a new value must be sent (variation starting from the last transmission). The possible values are:

- at change of 1 %
- at change of 2 %
- at change of 3 %
- **at change of 5 %** (default value)
- at change of 7 %
- at change of 10 %
- at change of 15 %

### 14.1.5 Cyclical transmission of actuating value every

Used to specify a cyclical transmission time for the control variable. The possible values are:

- Don't transmit cyclically
- 3 min, 5 min, 10 min, **15 min**, 20 min, 30 min, 60 min (default value)

### 14.1.6 Report when heating required but heating disabled

This parameter can be used to signal when heating is required but is blocked. The signalling is made via the **Heating required but heating disabled** (DPT 1.001 Switch) object, sending an error message when heating should be activated owing to the temperature but it is blocked by the **Disable heating** (DPT 1.001 Switch) object. The possible values are:

- **Only if object value = 1**
- Always cyclically

### 14.1.7 Report cyclically

Used to specify a cyclical transmission time for the error message. The possible values are:

- 3 min, 5 min, 10 min, 15 min, 20 min, **30 min**, 60 min (default value)

## 14.2 Parameters with the supported function Cooling

--- KNX FAN COIL ACTUATOR 0-10V - DIN RAIL > Regulation

General	Setting of control parameters	<input type="radio"/> standard <input checked="" type="radio"/> user defined
Fan	Proportional band of cooling controller	4 K
Cooling valve	Integral time of cooling controller	90 min
Auxilliary relay	Transmission of actuating value	at change of 5 %
E1	Cyclical transmission of actuating value every	don't transmit cyclically
Drip tray monitoring	Report, when cooling required but cooling disabled	<input checked="" type="radio"/> only if object value = 1 <input type="radio"/> always cyclically
Set point adjustment	Report cyclically	every 30 min
Set point values		

Regulation

Fig. 14.2 – “Regulation” menu with Supported function = Cooling

### 14.2.1 Setting of control parameters

This parameter specifies whether to leave the standard setting for the regulation parameters, or personalise them. The possible values are:

- **Standard** (default value)
- User defined

If **user defined** is selected, the regulation parameters can be individually set, so the following parameters will appear: “**Proportional band of cooling controller**” e “**Integral time of cooling controller**”.

### 14.2.2 Proportional band of cooling controller

Professional setting for adapting the regulation behaviour to the room.

Small values make big changes to the control variable, whereas large values make a more limited change. The possible values are (**standard value=4 K**):

- 1 K, 1.5 K, 2 K, 2.5 K, 3 K, 3.5 K, **4 K**, 4.5 K, 5 K, 5.5 K, 6 K, 6.5 K, 7 K, 7.5 K, 8 K, 8.5 K

### 14.2.3 Integral time of cooling controller

Setting of the regulator integration time, selected as a pure proportional regulator, or setting of an integration time (for PI regulator only). The integration time determines the regulation reaction time. These times can be altered to suit the conditions. If the cooling system is oversized and therefore too fast, shorter times should be selected. On the other hand, longer integration times are needed if the cooling system is small (slow).

The possible values are:

- Only proportional controller

- 15 min, 30 min, 45 min, 60 min, 75 min, **90 min**, 105 min, 120 min, 135 min, 150 min, 165 min, 180 min, 195 min, 210 min, 225 min.

For more information, refer to [par. 19.9 Regulating the temperature in Annex 2](#).

#### 14.2.4 Transmission of actuating value

This parameter can be used to define the % variation of the control variable after which a new value must be sent (variation starting from the last transmission). The possible values are:

- at change of 1 %
- at change of 2 %
- at change of 3 %
- **at change of 5 %** (default value)
- at change of 7 %
- at change of 10 %
- at change of 15 %

#### 14.2.5 Cyclical transmission of actuating value every

Used to specify a cyclical transmission time for the control variable. The possible values are:

- **Don't transmit cyclically** (default value)
- 3 min, 5 min, 10 min, 15 min, 20 min, 30 min, 60 min

#### 14.2.6 Report when cooling required but cooling disabled

This parameter can be used to signal when cooling is required but is blocked. The signalling is made via the **Cooling required but cooling disabled** (DPT 1.001 Switch) object, sending an error message when heating should be activated owing to the temperature but it is blocked by the **Enable cooling** (DPT 1.001 Switch) object. The possible values are:

- **Only if object value = 1**
- Always cyclically

#### 14.2.7 Report cyclically

Used to specify a cyclical transmission time for the error message. The possible values are:

- 3 min, 5 min, 10 min, 15 min, 20 min, **30 min**, 60 min (default value)

## 14.3 Parameters with the supported function Heating/Cooling

-.- KNX FAN COIL ACTUATOR 0-10V - DIN RAIL > Regulation		
General	Proportional band of heating controller	4 K ▼
Fan	Setting of control parameters	<input type="radio"/> standard <input checked="" type="radio"/> user defined
Heating/cooling valve	Integral action time constant of heating controller	90 min ▼
Auxilliary relay	Proportional band of cooling controller	4 K ▼
E1	Integral time of cooling controller	90 min ▼
Drip tray monitoring	Transmission of actuating value	at change of 5 % ▼
Set point adjustment	Cyclical transmission of actuating value every	15 min ▼
Set point values	Report, when no energy medium	<input checked="" type="radio"/> only if object value = 1 <input type="radio"/> always cyclically
	Report cyclically	every 30 min ▼
<b>Regulation</b>		

Fig. 14.3 – “Regulation” menu with Supported function = Heating/Cooling

### 14.3.1 Setting of control parameters

This parameter specifies whether to leave the standard setting for the regulation parameters, or personalise them. The possible values are:

- **Standard** (default value)
- User defined

If **user defined** is selected, the regulation parameters can be individually set, so the following parameters will appear: **Proportional band of heating controller.**” and **“Integral action time constant of heating controller.”**, **“Proportional band of cooling controller”** and **“Integral time of cooling controller”**.

### 14.3.2 Proportional band of heating controller

Professional setting for adapting the regulation behaviour to the room. Small values make big changes to the control variable, whereas large values make a more limited change. The possible values are (**standard value=4 K**):

- 1 K, 1.5 K, 2 K, 2.5 K, 3 K, 3.5 K, **4 K**, 4.5 K, 5 K, 5.5 K, 6 K, 6.5 K, 7 K, 7.5 K, 8 K, 8.5 K

### 14.3.3 Integral action time constant of heating controller

Setting of the regulator integration time, selected as a pure proportional regulator, or setting of an integration time (for PI regulator only). The possible values are (**default value=90 min**):

- Only proportional controller
- 15 min, 30 min, 45 min, 60 min, 75 min, **90 min**, 105 min, 120 min, 135 min, 150 min, 165 min, 180 min, 195 min, 210 min, 225 min.

### 14.3.4 Proportional band of cooling controller

Professional setting for adapting the regulation behaviour to the room.

Small values make big changes to the control variable, whereas large values make a more limited change.

The possible values are (**default value 4K**):

- 1 K, 1.5 K, 2 K, 2.5 K, 3 K, 3.5 K, **4 K**, 4.5 K, 5 K, 5.5 K, 6 K, 6.5 K, 7 K, 7.5 K, 8 K, 8.5 K

### 14.3.5 Integral time of cooling controller

Setting of the regulator integration time, selected as a pure proportional regulator, or setting of an integration time (for PI regulator only). The integration time determines the regulation reaction time. These times can be altered to suit the conditions. If the cooling system is oversized and therefore too fast, shorter times should be selected. On the other hand, longer integration times are needed if the cooling system is small (slow).

The possible values are:

- Only proportional controller
- 15 min, 30 min, 45 min, 60 min, 75 min, **90 min**, 105 min, 120 min, 135 min, 150 min, 165 min, 180 min, 195 min, 210 min, 225 min.

For more information, refer to [par. 19.9 Regulating the temperature in Annex 2](#).

### 14.3.6 Heating/Cooling

This parameter, visible if the system is a **4-pipe system**, specifies whether the device should be automatically switched to Cooling mode when the real temperature is higher than the threshold, or if Cooling mode should only be activated via the BUS on the **Heating/Cooling** (DPT 1.001 Switch) object. The possible values are:

- **auto** (default value)
- via object

With **auto**, the actuator switches to **Cooling** mode automatically when the real temperature is higher than the threshold.

With **via object**, Cooling mode can only be activated on the BUS side via the object **Heating/Cooling** (DPT 1.001 Switch), value 1= Cooling. If this object is not set (= 0), Cooling mode remains deactivated. The values can be inverted using the following parameter.

### 14.3.7 Format object heating/cooling

This parameter, only visible in a 4-pipe system with built-in regulator, specifies the possible values for the **Heating/Cooling** (DPT 1.001 Switch) object for switching between Heating and Cooling.

- **DPT 1.100 (Heating = 1 / Cooling = 0)** (default value)
- inverted (Heating = 0 / Cooling = 1)

### 14.3.8 Transmission of actuating value

This parameter can be used to define the % variation of the control variable after which a new value must be sent (variation starting from the last transmission). The possible values are:

- at change of 1 %
- at change of 2 %
- at change of 3 %
- **at change of 5 %** (default value)
- at change of 7 %
- at change of 10 %
- at change of 15 %

### 14.3.9 Cyclical transmission of actuating value every

Used to specify a cyclical transmission time for the control variable. The possible values are:

- Don't transmit cyclically
- 3 min, 5 min, 10 min, **15 min**, 20 min, 30 min, 60 min (default value)

### 14.3.10 Report when no energy medium

This parameter signals an error message on the **No energy medium** (DPT 1.001 Switch) object when heating or cooling needs to be activated owing to the temperatures, but the status of the **Heating/Cooling** (DPT 1.001 Switch) object is in conflict with this condition (in 2-pipe systems). In 4-pipe systems, the status of the **Heating/Cooling** (DPT 1.001 Switch) object is taken into consideration. The possible values are:

- **Only if object value = 1**
- Always cyclically

### 14.3.11 Report cyclically

Used to specify a cyclical transmission time for the error message. The possible values are:

- 3 min, 5 min, 10 min, 15 min, 20 min, **30 min**, 60 min (default value)



## 15 “Operating mode and operation” menu

The **Operating mode and operation** menu is only visible if the “**Kind of used controller**” specified in the **General** menu is **Internal controller with temp. sensor at E1**.

This menu is used to configure certain parameters for managing the operating mode in specific circumstances.

--- KNX FAN COIL ACTUATOR 0-10V - DIN RAIL > Operating mode and operation

General	Operating mode after reset	standby
Fan	Cyclical transmission of current op. mode every	don't transmit cyclically
Heating valve	Mode setting objects	<input checked="" type="radio"/> new: operating mode, presence, window state <input type="radio"/> old: comfort, night, frost (not recommended)
Cooling valve	Kind of presence detector	<input checked="" type="radio"/> presence detector <input type="radio"/> presence push button
Auxilliary relay	Manual offset applies	for comfort, standby and night
E1	Limitation of manual value increasing/decreasing	+/- 3 K
Drip tray monitoring		
Set point adjustment		
Set point values		
Regulation		

[Operating mode and operati...](#)

Fig. 15.1 – “Operating mode and operation” menu

### 15.1 Parameters

#### 15.1.1 Operating mode after reset

This parameter specifies which mode must be active after the device has been set up with ETS or has been reprogrammed. The possible values are:

- Frost/Heat protection
- Night reduction
- **Standby (default value)**
- Comfort

#### 15.1.2 Cyclical transmission of current op. mode every

This parameter specifies whether the active mode (indicated on the BUS by sending the **Current operating mode** (DPT 20.102 HVAC mode) object) should be sent cyclically. The possible values are:

- **Don't transmit cyclically (default value)**
- 3 min, 5 min, 10 min, 15 min, 20 min, 30 min, 60 min

### 15.1.3 Mode setting objects

The device can change the temperature control mode on the basis of the window contacts and the presence of people.

Depending on the selection made with this parameter, the names and formats of objects 21, 22 and 23 will be different.

The possible values are:

- **new: Operating mode, presence, window state** (default value)
- old: Comfort, Night, frost. (not recommended)

If **new: Operating mode, presence, window state** is selected, the **Operating mode preset** (DPT 20.102 HVAC mode), **Presence** (DPT 1.018 occupancy) and **Window** (DPT 1.019 window/door) objects will be made visible.

With the **Operating mode preset** (DPT 20.102 HVAC mode) object, one of the four HVAC modes can be activated directly (1= Comfort, 2=Standby, 3=Night, 4=Frost Protection (in heating, or Overtemperature Protection in cooling)). If another different value is received (0 or a number >4), Comfort mode is activated.

The **Presence** (DPT 1.018 occupancy) object allows the presence indicator status (e.g. a push-button or a movement sensor) to be received. If a value = 1 is received on this object, the device activates Comfort mode.

The **Window** (DPT 1.019 window/door) object allows the status of a window contact to be received. A value = 1 on this object activates Frost Protection / Heat Protection mode

If you select **old: Comfort, Night, frost . (not recommended)** (the traditional setting without window or presence status), the **Night mode <-> Standby** (DPT 1.001 Switch), **Comfort** (DPT 1.001 Switch), **Frost protection** (DPT 1.001 Switch) objects will be made visible.

With the **Night mode <-> Standby** (DPT 1.001 Switch) object, Night or Standby mode can be activated.

With the **Comfort** (DPT 1.001 Switch) object, the device activates Comfort mode if it receives a value = 1 on this object. This mode takes priority over Night and Standby. Comfort mode is deactivated by sending a value = 0 on the object.

With the **Frost protection** (DPT 1.001 Switch) object, the device activates Frost Protection mode if it receives a value = 1. In Cooling mode, Heat Protection is activated. Frost Protection / Heat Protection takes maximum priority. Frost Protection / Heat Protection remains active until it is deactivated with a 0.

### 15.1.4 Kind of presence detector

This parameter specifies whether the presence of people is signalled via a presence sensor or a push-button. In the case of a push-button, the next parameter - "**Time for comfort extension**" - appears so you can define how long the regulator must stay in Comfort mode once the presence of people has been detected (not necessary if a sensor is used).

The possible values are:

- **Presence detector** (default value)
- Presence push button

If **Presence detector** is selected, the presence sensor activates Comfort mode and remains active as long as it is enabled by the presence object **Presence** (DPT 1.018 occupancy).

If **Presence push button** is selected and, following activation via the presence object **Presence** (DPT 1.018 occupancy), an HVAC mode change is received on the **Operating mode preset** (DPT 20.102 HVAC mode) object, the new mode will be enabled and the presence object will be reset. If the presence object is set in Night / Frost Protection mode, the reset is only made at the end of the configured "**Time for comfort extension**" (see below). The presence object is not signalled on the BUS.

### 15.1.5 Time for comfort extension

If a **Presence push button** is used, this parameter tells the regulator how long it must remain in Comfort mode once the presence of people has been signalled via the push-button. The possible values are:

- 30 min.
- 1 h
- 1.5 h
- **2 h** (default value)
- 2.5 h
- 3 h
- 3.5 h

### 15.1.6 Manual offset applies

This parameter specifies which modes the manual programmed value variation must be active in. The possible values are:

- **for Comfort, Standby and Night** (default value)
- for Comfort and Standby
- only for Comfort

### 15.1.7 Limitation of manual value increasing/decreasing

This parameter limits the variation from the nominal value received on the object **Manual adjustment** (DPT 9.002 temperature difference – K). The value expresses, in K, the maximum permitted variation (plus or minus) from the nominal value. The possible values are:

- No increasing/decreasing
- +/- 1 K
- +/- 2 K
- **+/- 3 K** (default value)
- +/- 4 K
- +/- 5 K

## 16 “Filter monitoring” menu

The **Filter monitoring** menu is only visible if the “**Report filter change**” parameter in the **General** menu has been set to **yes**.

This menu is used to configure certain parameters for managing filter monitoring and the replacement signal.

--- KNX FAN COIL ACTUATOR 0-10V - DIN RAIL > Filter monitoring

General	Message for filter change after duty time of (1..127 weeks)	12
Fan	Transmit filter replacement cyclically	<input checked="" type="radio"/> only at filter change <input type="radio"/> always cyclically
Heating valve	Transmit fan duty time (in hours)	never transmit (reading is possible)
Cooling valve	Cycle time for filter replacement and fan duty time	every 60 min
Auxilliary relay		
E1		
Drip tray monitoring		
Set point adjustment		
Set point values		
Regulation		
Operating mode and operation		

[Filter monitoring](#)

Fig. 16.1 – “Filter monitoring” menu

### 16.1 Parameters

#### 16.1.1 Message for filter change after duty time of (1..127 weeks)

This parameter specifies how often the device must signal a filter change. The signalling is made by sending the **Change filter** (DPT 1.001 Switch) object with value = 1 (1= change, 0=reset). The value, from 1 to 127, is entered manually and defines the gap between two filter changes in terms of weeks:

- From 1 to 127                   **(12 default value)**

#### 16.1.2 Transmit filter replacement cyclically

This parameter specifies when the filter change signal must be sent via the **Change filter** (DPT 1.001 Switch) object. The possible values are:

- **Only at filter change**                   **(default value)**
- Always cyclically

If **only at filter change** is selected, the **Change filter** (DPT 1.001 Switch) object is only sent when the filter needs to be changed (value 1 = change filter).

If **always cyclically** is selected, the **Change filter** (DPT 1.001 Switch) object sends the filter status cyclically (0 = filter OK, 1= change filter).

### 16.1.3 Transmit fan duty time (in hours)

The fan operating time is calculated internally with great precision (to the second), but the value is not sent automatically. This parameter specifies whether the device should send the fan operating time (in hours) via the **Fan duty time since last filter change** (DPT 7.007 time - h) object in response to a request (e.g. from a supervisor), only on change, or cyclically and on change.

The possible values are:

- **Never transmit (reading is possible)** (default value)
- Only on changes
- Cyclically and on changes

With **Never transmit (reading is possible)**, the device only sends the value if a read request is received from the BUS on the object **Fan duty time since last filter change** (DPT 7.007 time - h).

With **Only on changes**, the counter level is sent whenever the fan operating time increases by one hour.

With **Cyclically and on changes**, the hour count is sent on the basis of the time specified in the “**Cycle time for filter replacement and fan duty time**” parameter and on change.

**NB:** the counter and filter status are reset when the **Change filter** (DPT 1.001 Switch) object is received with value = 0.

### 16.1.4 Cycle time for filter replacement and fan duty time

This parameter specifies the time for the cyclical transmission of the counter level. The possible values are (**every 60 min default value**):

- Every 3 min, every 5 min, every 10 min, every 15 min, every 20 min, every 30 min, every 45 min, **every 60 min**

## 17 “Actuating value loss” menu

The **Actuating value loss** menu is only visible if the **Activate monitoring on actuating value** parameter in the **General** menu has been set to **yes** in the case of a remote controller.

This menu is used to configure certain parameters for managing control variable monitoring.

--- KNX FAN COIL ACTUATOR 0-10V - DIN RAIL > Actuating value loss

General	Monitoring time for actuating value	<input type="radio"/> 30 min <input checked="" type="radio"/> 60 min
Fan	Substitute actuating value emergency program	20 % ▼
Heating valve	Report actuating value loss cyclically (1 = no act. value)	<input checked="" type="radio"/> only if object value = 1 <input type="radio"/> always cyclically
Cooling valve	Report cyclically	every 30 min ▼
Auxilliary relay		
E1		
Drip tray monitoring		
Set point adjustment		
Filter monitoring		

[Actuating value loss](#)

Fig. 17.1 – “Actuating value loss” menu

### 17.1 Parameters

#### 17.1.1 Monitoring time for actuating value

If no control variable is received within the time configured, the substitute control variable is used. The possible values are:

- 30 min
- **60 min** (default value)

#### 17.1.2 Substitute actuating value emergency program

Control variable for the emergency program as long as the ambient thermostat receives no new control variable. The possible values are:

- 0%, 10%, **20%**, 30%, 40%, 50%, 60%, 70%, 80%, 90%, 100% (default value)

### 17.1.3 Report actuating value loss cyclically (1= no act. value)

This parameter is used to define whether the **Actuating value loss** (DPT 1.001 Switch) object must be sent only in the event of a control variable error, or cyclically (with a time defined in the “**Report cyclically**” parameter). The possible values are:

- **Only if object value = 1 (default value)**
- Always cyclically

### 17.1.4 Report cyclically

If “always cyclically” is selected in the previous parameter, this parameter can specify the time for the cyclical transmission of the control variable status via the **Actuating value loss** (DPT 1.001 Switch) object. The possible values are (**every 30 min default value**):

- Every 3 min, every 5 min, every 10 min, every 15 min, every 20 min, **every 30 min**, every 45 min, every 60 min

## 18 Annex 1: Initial start-up

### 18.1 Test mode

Test mode is used to check the system, for instance during start-up or when looking for errors. In this mode, the button keys can be used to manually set the valves and fan as required. A temperature sensor (GWA9145 - NTC 100K TEMPERATURE SENSOR) or window contacts can also be checked.

#### Important indications for test mode:

- Regulation and BUS telegrams are deactivated.
- All the settings can be made, without limits.
- The valves are commanded until they are manually deactivated.
- The drip tray alarm is not taken into consideration.
- **The user is responsible for avoiding unpermitted operating conditions (e.g. heating and cooling valves both open simultaneously).**

#### Enabling / cancelling test mode:

Test mode is enabled or cancelled via the “**Test mode** parameter with **enabled during 1 min. after reset** on the **General** parameter page.

#### Activating test mode:

Activate the **reset** by means of a download or the enabling of the BUS voltage:

→ The test mode LED will flash for 1 minute.

During this time, test mode can be launched via the valve button key (☼/))) or the fan button key (∞).

→ The device switches to test mode and the "Test" LED lights up with a fixed light.

#### Deactivating test mode:

Test mode can be terminated by simultaneously pressing the two button keys or downloading the application (via the “**Test mode**” = disabled parameter)

**If no button key is used while the test mode LED is flashing, the device switches automatically to normal mode after one minute.**

*During the initial start-up (i.e. with no application program), the LED flashes with no time limit.*

#### Operation:

- Commanding the fan:

Press button key A (fan) to apply the following operation statuses in the order shown.

**Table 18.1: standard fan command**

Press on button key	Function	LED
1	Fan level 1	S1 ON
2	Fan level 2	S2 ON
3	Fan level 3	S3 ON
4	Fan OFF	S1-S3 OFF



**Table 18.2: 0-10V fan command**

Press on button key	Speed	LED
1	33%	S1 ON
2	66%	S2 ON
3	100%	S3 ON
4	Fan OFF	S1-S3 OFF

- Commanding the valves / Switching the additional relay:

Press button key A (valves) to apply the following operation statuses in the order shown.

**Table 18.3:**

Press on button key	LED	Output
1	Cooling LED ON	After 2 s [V2+] = 10V
2	Cooling LED flashing	After 2 s [V2+] = 0V
3	Heating LED ON	After 2 s [V1+] = 10V
4	Heating LED flashing	After 2 s [V1+] = 0V
5	LED C1 ON	After 2 s C1 ON
6	All the LEDs OFF	All the outputs OFF

With delayed switching of the outputs, the user can use quick button key selection to skip the individual modes without modifying the valve position.

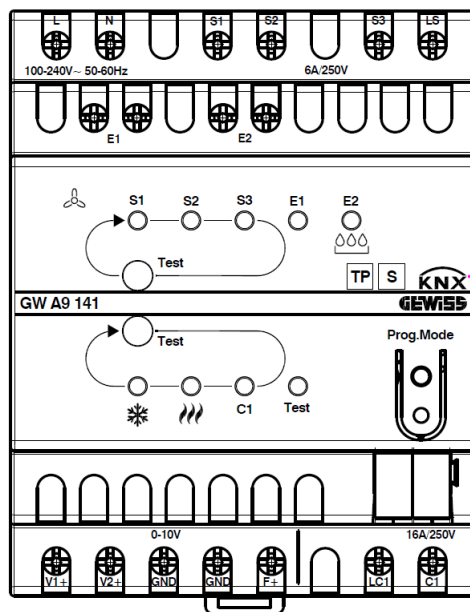



Figure 18.1

**Table 18.4: Indication of the heating and cooling valve status.**

LED	Status	Meaning
	OFF	The cooling valve is closed (0V)
	ON	The cooling valve is open (> 0V)
	Flashing	The cooling valve is closed (0V)
	OFF	The heating valve is closed (0V)
	ON	The heating valve is open (> 0V)
	Flashing	The heating valve is closed (0V)

**Checking the temperature sensor (GWA9145 - NTC 100K TEMPERATURE SENSOR):**

If a temperature sensor is connected to input E1, and E1 is suitably configured in the application, the measured ambient temperature is sent on object 14 **Actual value from E1** (DPT 9.001 Temperature - °C).

A broken sensor or a short-circuit on the sensor cable is signalled by the value -60°C.

**Checking the window contacts:**

If a window contact is connected to input E1, and E1 is suitably configured in the application, the window status is sent on object 14 **Status of window contact at E1** (DPT 1.019 window/door)

Input E2 (object 16, Drip tray monitoring status or Status of window contact at E2) can be checked in the same way.

**Configuring the device upon delivery (prior to the initial start-up with ETS):**

Before downloading the application software for the first time via ETS, inputs E1 and E2 and the additional relay C1 are already connected to common group addresses:

E1 = 7/4/100

E2 = 7/4/101

C1 = 7/4/100, 7/4/101

If the contact on E1 or E2 is closed, the additional relay C1 is activated. This makes it possible to check both inputs during installation without ETS.

## 18.2 Device LEDs in automatic mode

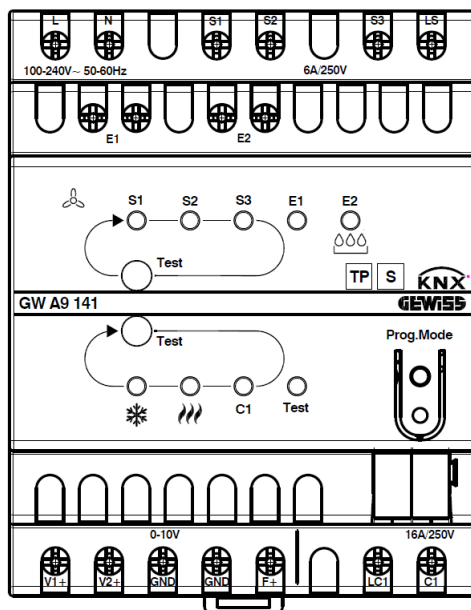

Figure 18.2

LED	Function	Explanation
S1	Fan level 1	Lights up when fan level 1 is active or with fan speed 1 - 32% (the <i>switch-on strategy</i> is not taken into consideration).
S2	Fan level 2	Lights up when fan level 2 is active or with fan speed 33 - 65% (the <i>switch-on strategy</i> is not taken into consideration).
S3	Fan level 3	Lights up when fan level 3 is active or with fan speed 66 - 100% (the <i>switch-on strategy</i> is not taken into consideration).
	Cooling	Lights up when the cooling valve is open. Flashes when the opening of the cooling valve is delayed because the heating valve has not yet closed completely or the <i>Time between heating and cooling</i> has not terminated.
	Heating	Lights up when the heating valve is open. Flashes when the opening of the heating valve is delayed because the cooling valve has not yet closed completely or the <i>Time between heating and cooling</i> has not terminated.
C1	Additional relay	Lights up when the additional relay is activated.
Test	Test mode	Flashes after the reset, when <i>Test mode</i> can be selected or when the device has not yet been programmed. Lights up when the device is in <i>Test mode</i> .
E1	Input 1	If used as a <i>Window contact</i> : Lights up when the contact is closed. If used as a <i>Real value sensor</i> : Remains OFF in the normal temperature range (i.e. -10°C to 60°C). Flashes if there is an interruption or short-circuit on the sensor line and the temperature is outside the normal range.
E2	Input 2	If used as a <i>Window contact</i> (only with <i>Supported function</i> = <i>Heating</i> or <i>Ventilation</i> ): Lights up when the contact is closed. With <i>Supported function</i> = <i>Heating and Cooling</i> or <i>Cooling</i> : Flashes if there is a drip tray alarm, regardless of the <i>Drip tray monitoring source</i> .

## 19 Annex 2: Functional temperature control specifications

### 19.1 Control variable monitoring

#### 19.1.1 Use

If there is a fault on the external ambient thermostat, and the last control variable sent was equal to 0%, all the valves remain closed regardless of the ambient temperature trend.

This can cause considerable damage if, for example, the outdoor temperature is below zero and cold air enters the room.

To avoid this risk, the GWA9141 device guarantees the following functions:

1. monitoring of the correct operation of the ambient thermostat
2. launch of an emergency program in the event of a control variable error
3. transmission of the control variable monitoring status

#### 19.1.2 Principle

GWA9141 checks that at least 1 control variable telegram is received within the time configured, and applies a predefined nominal value in the event of a control variable error.

#### 19.1.3 Practice

The ambient thermostat is configured on the cyclical transmission of the control variable.

The monitoring time in the GWA9141 is set on a value at least double that of the cyclical ambient thermostat time.

For example, if the ambient thermostat sends the control variable every 15 minutes, the monitoring time must be at least 30 minutes.

Following a control variable error, normal operation is resumed as soon as a new control variable is received.

When the lock function is activated (object 1: *Disable heating* = 1 or *Enable cooling* = 0), only the control variable error telegram is sent.

The relative valve remains/is closed and the configured control variable emergency program is only applied when the lock has been removed.

## 19.2 Characteristic valve curve setting

The parameters of the *Heating valve* and *Cooling valve* pages allow the exact adaptation to the type of valve used, and also allow the regulation to be adjusted.

Example for a valve that begins opening at a position of 10% and is already fully open at 80%.

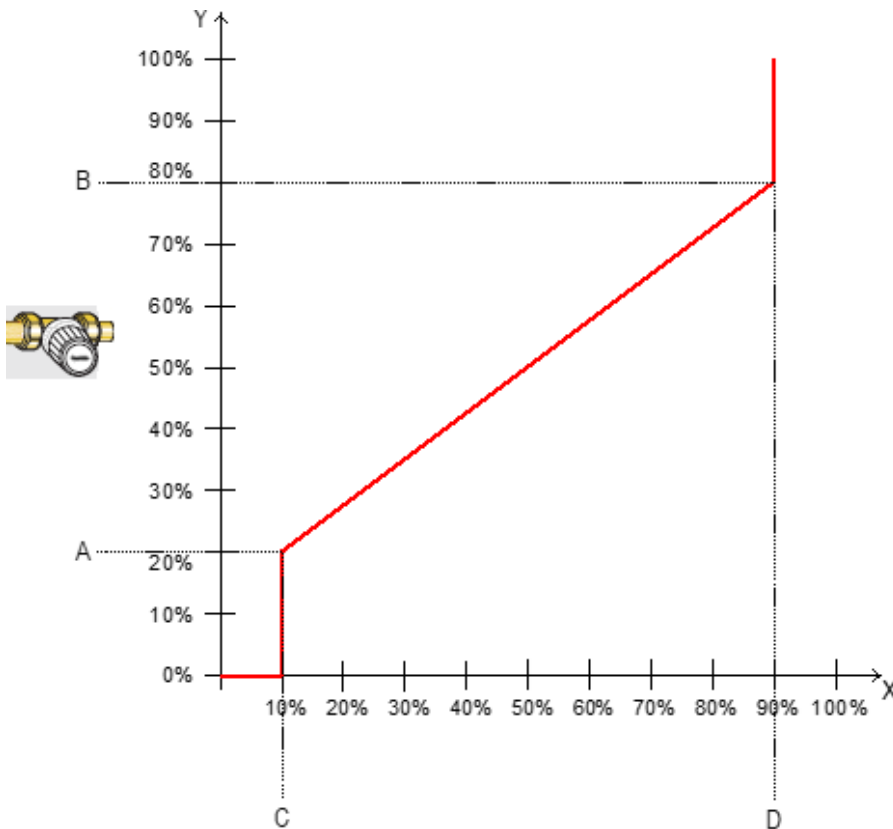

Figure 19.1

Table 19.1

	Description	Value
X	Regulator control variable	0 .. 100%
Y	Resulting valve position	0 .. 100%
A	Parameter: Minimum valve position	20%
B	Parameter: Maximum valve position	80%
C	Parameter: Open for actuating value above	10%
D	Parameter: Maximum valve position above	90%

### 19.3 Nominal value adjustment

The active nominal value can be adjusted via object 25 "**Manual adjustment**", by a maximum of +/- 5 K.

Every time a modification is made, the new nominal value is sent by the **Current set point value** object (object 27).

The variation limits are fixed in the **Operating mode and operation** menu, via the "**Limitation of manual value increasing/decreasing**" parameter. On this menu page, you can define in which HVAC mode a programmed value variation is possible. See the "**Manual offset applies**" parameter.

### 19.4 Nominal value adaptation

The nominal value adjustment dynamically adapts the nominal value to the outdoor temperature in cooling mode.

If the outdoor temperature exceeds a defined threshold, the adjustment is activated and the corresponding increase of the nominal value is established.

#### 19.4.1 Using with the built-in regulator

Nominal value adaptation can also be used for the built-in regulator. In this case, the "**Use set point adjustment for regulation**" parameter in the **Set point adjustment** menu must be set on **yes**.

The adaptation of the nominal value of the built-in regulator ("**Base set point after reset**") is always relative, i.e. it is increased or reduced by the correction value defined (see Figure 19.2 below).

In addition, it is possible to generate an independent nominal value that makes the adaptation available to any other regulators in the building (see below, par. 19.4.4: [Format of the nominal value correction: absolute](#)).

#### 19.4.2 Using with an external regulator

For external regulators, there are two possible types of nominal value correction: relative and absolute.

See also: [Menu Nominal value adaptation](#).

#### 19.4.3 Format of the nominal value correction: relative

The adaptation of the nominal value is sent by object 19 **Adjust set point** (DPT 9.002 temperature difference) as a temperature difference.

The value 0 is sent until the nominal value correction threshold, set with the "**Set point adjustment from**" parameter, is reached.

If the nominal value correction threshold is exceeded, the value is increased by 1 K every time the outdoor temperature increases by the value set in the "**Adjustment**" parameter.

##### Example: correction value sent

"*Programmed value correction from*": 25°C

Figure 19.2: Correction value on the basis of the outdoor temperature

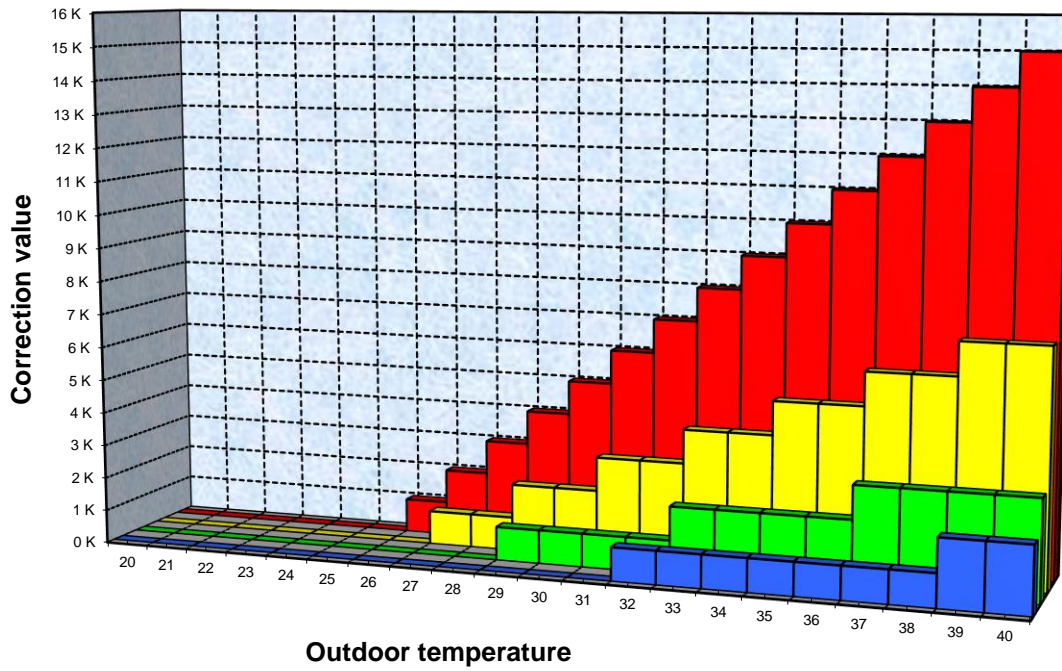

- 1 K per 7 K outdoor temperature
- 1 K per 4 K outdoor temperature
- 1 K per 2 K outdoor temperature
- 1 K per 4 K outdoor temperature

**Table 19.2: Correction values**

Outdoor temp.	1K/1K	1K/2K	1K/3K	1K/4K	1K/5K	1K/6K	1K/7K
20	0 K	0 K	0 K	0 K	0 K	0 K	0 K
21	0 K	0 K	0 K	0 K	0 K	0 K	0 K
22	0 K	0 K	0 K	0 K	0 K	0 K	0 K
23	0 K	0 K	0 K	0 K	0 K	0 K	0 K
24	0 K	0 K	0 K	0 K	0 K	0 K	0 K
25	0 K	0 K	0 K	0 K	0 K	0 K	0 K
26	1 K	0 K	0 K	0 K	0 K	0 K	0 K
27	2 K	1 K	0 K	0 K	0 K	0 K	0 K
28	3 K	1 K	1 K	0 K	0 K	0 K	0 K
29	4 K	2 K	1 K	1 K	0 K	0 K	0 K
30	5 K	2 K	1 K	1 K	1 K	0 K	0 K
31	6 K	3 K	2 K	1 K	1 K	1 K	0 K
32	7 K	3 K	2 K	1 K	1 K	1 K	1 K
33	8 K	4 K	2 K	2 K	1 K	1 K	1 K
34	9 K	4 K	3 K	2 K	1 K	1 K	1 K
35	10 K	5 K	3 K	2 K	2 K	1 K	1 K
36	11 K	5 K	3 K	2 K	2 K	1 K	1 K
37	12 K	6 K	4 K	3 K	2 K	2 K	1 K
38	13 K	6 K	4 K	3 K	2 K	2 K	1 K
39	14 K	7 K	4 K	3 K	2 K	2 K	2 K
40	15 K	7 K	5 K	3 K	3 K	2 K	2 K



### 19.4.4 Format of the nominal value correction: absolute

This nominal value is calculated as follows:  
*standard nominal value without correction + dead zone + adaptation.*

**Example:**

*“Programmed value correction from”: 25°C, Standard nominal value without correction: 21°C, Dead zone = 2 K*

**Figure 19.3: Adaptation of the nominal value on the basis of the outdoor temperature**

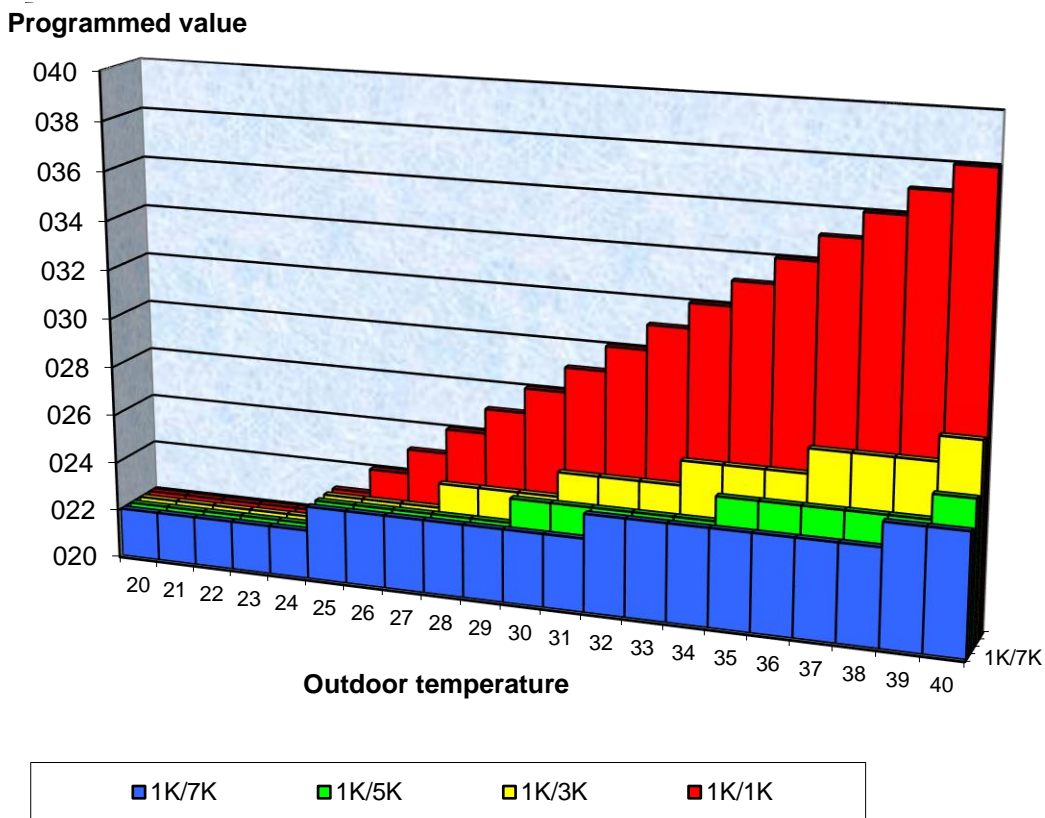

**Table 19.3: Programmed values**

Outdoor temp.	1K/1K	1K/2K	1K/3K	1K/4K	1K/5K	1K/6K	1K/7K
20	22.00	22.00	22.00	22.00	22.00	22.00	22.00
21	22.00	22.00	22.00	22.00	22.00	22.00	22.00
22	22.00	22.00	22.00	22.00	22.00	22.00	22.00
23	22.00	22.00	22.00	22.00	22.00	22.00	22.00
24	22.00	22.00	22.00	22.00	22.00	22.00	22.00
25	23.00	23.00	23.00	23.00	23.00	23.00	23.00
26	24.00	23.00	23.00	23.00	23.00	23.00	23.00
27	25.00	24.00	23.00	23.00	23.00	23.00	23.00
28	26.00	24.00	24.00	23.00	23.00	23.00	23.00
29	27.00	25.00	24.00	24.00	23.00	23.00	23.00
30	28.00	25.00	24.00	24.00	24.00	23.00	23.00
31	29.00	26.00	25.00	24.00	24.00	24.00	23.00
32	30.00	26.00	25.00	24.00	24.00	24.00	24.00
33	31.00	27.00	25.00	25.00	24.00	24.00	24.00
34	32.00	27.00	26.00	25.00	24.00	24.00	24.00
35	33.00	28.00	26.00	25.00	25.00	24.00	24.00
36	34.00	28.00	26.00	25.00	25.00	24.00	24.00
37	35.00	29.00	27.00	26.00	25.00	25.00	24.00
38	36.00	29.00	27.00	26.00	25.00	25.00	24.00
39	37.00	30.00	27.00	26.00	25.00	25.00	25.00
40	38.00	30.00	28.00	26.00	26.00	25.00	25.00

## 19.5 Frost Protection mode (or heat protection) with window contact

### 19.5.1 With external regulator

The window contact is connected to E1. The window status is sent by object 14 **Status of window contact at E1** on the BUS, as an order for the external regulator.

The regulator can switch automatically to Frost Protection (or heat protection) mode if the window is opened.

The “**Function of E1**” parameter in the ETS **E1** menu must be set on **E1 = window contact**.

### 19.5.2 With built-in regulator

This function is only possible if the “**Mode setting objects**” parameter in the **Operating mode and operation** ETS menu is set on **New: operating mode, presence, window state**.

The “*Open window*” information can be detected in 2 different ways:

- The window contact is connected to a binary input (e.g. GW 90 727) and the window status is received on object 23 **Window – Input for window contact** (DPT 1.019 window/door).
- The window contact is connected to E2 (only possible with “**Supported functions**” = **Heating**). **Important:** the relative switching object (object 16, **Status of window contact at E2 - report**) must be connected with the group address to object 23 (**Window – Input for window contact**). GWA9140 detects the opening of the window and switches automatically to Frost Protection (heat protection) mode. When the window is closed, the previously set mode is restored.

## 19.6 Dead zone

The dead zone is a transit area between Heating and Cooling operation. Neither heating nor cooling is carried out within this area.

Without this transit area, the system would switch continuously between heating and cooling. As soon as the nominal value was exceeded, heating would be activated, but then cooling would begin as soon as the nominal value was reached so the temperature would fall below the nominal value and this would activate heating once again.

## 19.7 Determining the active mode

The active nominal value can be adapted to the varying needs by selecting temperature control mode. This mode can be defined using objects 21, 22, 23. There are two procedures:

### 19.7.1 New modes

In the **Operating mode and operation** ETS menu, if the “**Mode setting objects**” parameter is set on **New: operating mode, presence, window state**, the active mode can be defined as follows:

**Table 19.4**

Mode pre-selection Object 21	Presence Object 22	Window status Object 23	Active mode (Object 24)
As preferred	As preferred	1	Frost Protection/heat protection
As preferred	1	0	Comfort
Comfort	0	0	Comfort
Standby	0	0	Standby
Night	0	0	Night
Frost Protection/heat protection	0	0	Frost Protection/heat protection

**Typical application:**

With a control panel or another KNX device that can send the HVAC modes, object 21 **Operating mode preset** (DPT 20.102 HVAC mode) allows "Standby" or "Comfort" mode to be activated in the morning and "Night" in the evening.

For holiday periods, object 21 can be used to select Frost Protection/heat protection mode, which can be activated via another KNX device.

Object 22 **Presence – input for presence signal** is connected to a presence indicator. If any presence is detected, GWA9141 switches to Comfort mode (see table).

Object 23 **Window – input for window contact** is connected to a window contact via the BUS (binary input). As soon as the window is opened, GWA9141 switches to Frost Protection mode.

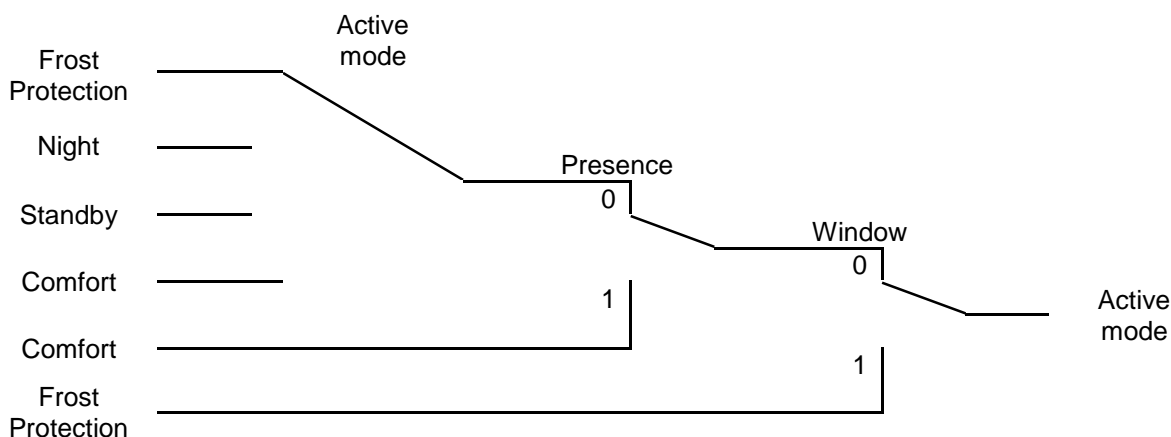

**Figure 19.4**

**19.7.2 Old mode**

In the **Operating mode and operation** ETS menu, if the “**Mode setting objects**” parameter is set on **old: comfort, night, frost (not recommended)**, the active mode can be defined as follows:

**Table 19.5**

Night Object 21	Comfort Object 22	Frost Protection/heat protection Object 23	Active mode Object 24
As preferred	As preferred	1	Frost Protection/heat protection
As preferred	1	0	Comfort
Standby	0	0	Standby
Night	0	0	Night

**Typical application:** With a control panel or another KNX device, object 21 **Night mode** <-> **Standby** allows "Standby" mode to be activated in the morning and "Night" in the evening.

For holiday periods, object 23 **Frost protection** can be used to select Frost Protection/heat protection mode, activated via a control panel or another KNX device

Object 22 **Comfort** is connected to a presence indicator. If any presence is detected, GWA9141 switches to Comfort mode (see table).

Object 23 **Frost protection** can be connected to a window contact. As soon as the window is opened, GWA9141 switches to Frost Protection mode.

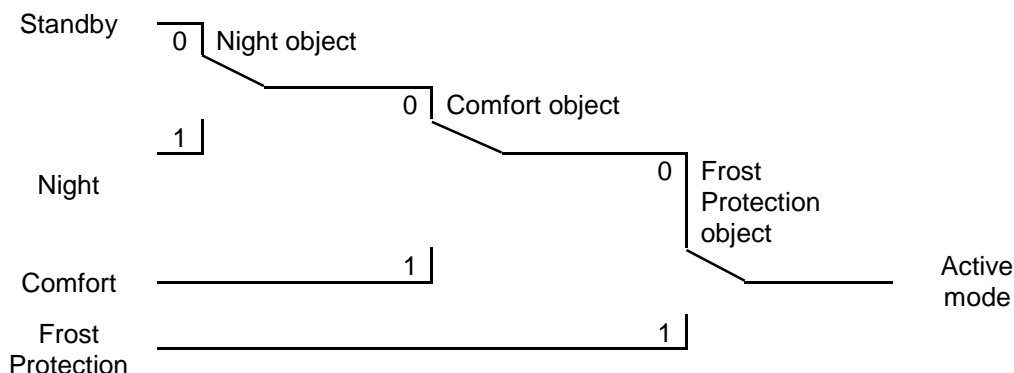

Figure 19.5

There are 2 disadvantages in the old procedure, compared with the new one:

1. To swap from Comfort mode to Night mode, 2 telegrams are needed (sent from a control panel, supervisor or another KNX device): object 22 must be set on "0" (Comfort - OFF) and object 21 on "1" (Night - ON).
2. If the window is opened and then closed again while "Frost Protection/heat protection" mode is selected, this mode will be removed.

### 19.7.3 Determining the nominal value

#### 19.7.3.1 Calculating the nominal value for Heating

Table 19.6: current nominal value for Heating

Operating mode	Current nominal value
<b>Comfort</b>	Standard nominal value +/- nominal value adjustment
Standby	Standard nominal value +/- nominal value adjustment - reduction in Standby mode
Night	Standard nominal value +/- nominal value adjustment - reduction in Night mode
Frost Protection/heat protection	Nominal parameterised value for Frost Protection mode

**Example:**

Heating in Comfort mode.

**Table 19.7: Parameter settings:**

ETS menu	Parameter	Setting
<i>Nominal values</i>	Standard programmed value after reset	21°C
	Reduction in Standby mode (during heating)	2 K
<i>Mode and operation</i>	Manual adjustment limit	+/- 2 K

The programmed value was previously increased by 1 K via the **Manual adjustment** object.

Calculation:

Current nominal value = Standard nominal value + nominal value adjustment

$$= 21^{\circ}\text{C} + 1 \text{ K} = 22^{\circ}\text{C}$$

If the change is made in Standby mode, the current nominal value is calculated as follows:

Current nominal value = Standard nominal value + nominal value adjustment - Reduction in Standby mode

$$= 21^{\circ}\text{C} + 1 \text{ K} - 2 \text{ K} = 20^{\circ}\text{C}$$

### 19.7.3.2 Calculating the nominal value for Cooling

**Table 19.8: current nominal value for Cooling**

Operating mode	Current nominal value
Comfort	Standard nominal value + nominal value adjustment + dead zone
Standby	Standard nominal value + nominal value adjustment + dead zone + increase in Standby mode
Night	Standard nominal value + nominal value adjustment + dead zone + increase in Night mode
Frost Protection/heat protection	Nominal parameterised value for heat protection mode

**Example:**

Cooling in Comfort mode.

The ambient temperature is too high so GWA9141 switches to Cooling mode.

**Table 19.9: Parameter settings:**

ETS menu	Parameter	Setting
General	Supported function	Heating and Cooling
Nominal values	Standard programmed value after reset	21°C
Nominal values	Dead zone between heating and cooling	2 K
	Increase in Standby mode.	2 K
Mode and operation	Manual adjustment limit	+/- 2 K

The nominal value was previously reduced by 1 K via object 25 **Manual adjustment**.

Calculation:

Current nominal value = Standard nominal value + nominal value adjustment + dead zone

$$= 21^{\circ}\text{C} - 1 \text{ K} + 2 \text{ K}$$

$$= 22^{\circ}\text{C}$$

A change in Standby mode leads to another increase in the nominal value (energy savings), which is then:

Nominal value = standard nominal value + nominal value adjustment + dead zone + increase in Standby mode

$$= 21^{\circ}\text{C} - 1 \text{ K} + 2 \text{ K} + 2 \text{ K}$$

$$= 24^{\circ}\text{C}$$

### 19.7.4 Heating and Cooling in a 2-pipe system

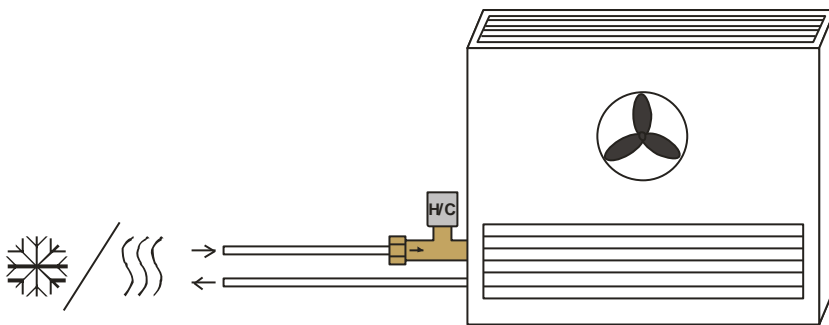

Figure 19.6

The following points need to be considered when using a 2-pipe heating/cooling system:

- In a 2-pipe system, the heating and cooling fluids (depending on the season) travel through the same pipes and are commanded by the same valve. This is connected to the valve terminals V1.
- The switch between heating fluid and cooling fluid is made by the system, and must therefore be signalled to the regulator. The heating/cooling system must send a 0 (in Heating mode) or a 1 (in Cooling mode) on object 1 "**Heating/Cooling**" of GWA9141 (or an inverted value on the basis of the setting of the "**Format object heating/cooling**" parameter in the **General** menu).

### 19.7.5 Heating and Cooling in a 4-pipe system

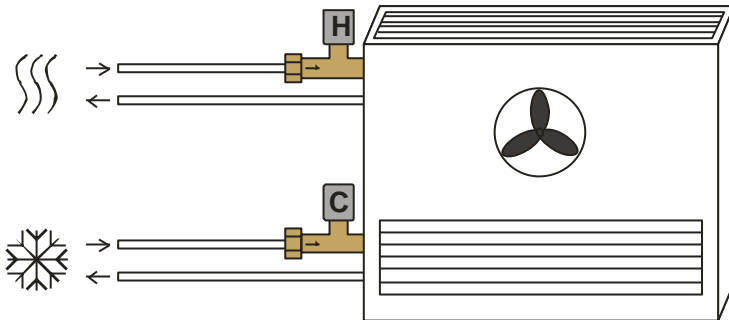

Figure 19.7

If a 4-pipe heating/cooling system is used, the heating valve is connected to terminals V1 and the cooling valve to terminals V2.

## 19.8 Fan check

### 19.8.1 Priorities

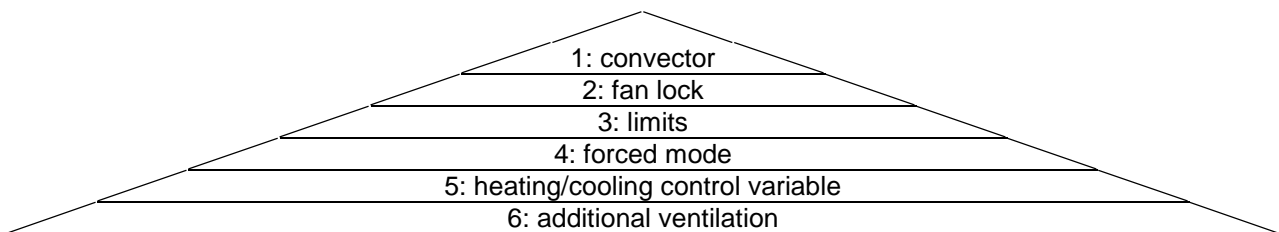

Figure 19.8

The “**Heating installation**” = *Convector / Fan Coil* and “**Cooling installation**” = *Convector / Fan Coil* parameters have top priority (1). In the case of a *Convector*, the fan is not commanded.

The “**Additional ventilation**” parameter has the lowest priority and is only taken into consideration if the fan is switched off because of the control variable and *Additional ventilation* is admitted in the parameter.

**Important:**

in normal Heating/Cooling mode, the “**Open for actuating value above**” parameter (in the **Heating valve**, **Cooling valve** or **Heating/Cooling valve** menu) is also considered.



**Table 19.10: Example with the parameter *Open for actuating value above = 40%*:**

Control variable	Fan behaviour
1 .. 39%	The fan is not started up because the valve is not open*.
40% .. 100%	The relative fan level is applied

\*The *Additional ventilation* function is still possible.

## 19.8.2 Forced fan mode

This function allows you to manually preselect the fan level via the KNX BUS.

**Note:** forced operation can be activated with 1 or 0.

Refer in particular to the “**Switch between auto and forced mode**” parameter on the **General** menu page. With this, you can not only change the value for activating operation, but also define the behaviour of the device at start-up. If “**via obj. Forced/auto, forced = 1**” is selected, automatic mode is active at start-up and forced mode must be activated by sending 1 on the dedicated object (object 15). If “**via obj. Auto/forced, forced = 0**” is selected, forced mode is active at start-up and automatic mode must be activated by sending 1 on the dedicated object (object 15).

With fan command = Standard:

The forced regulating value received (object 8) is applied as a fan level between 0 and 3 if Forced Command and format limit = Fan levels (0-3), or as a percentage value if Forced Command and format limit = percentage value (default).

With fan command = 0-10V:

The forced regulating value received (object 8) is applied as a percentage value.

**Behaviour on sending fan value in forced mode with “Switch between auto and forced mode via obj. Forced/auto, forced = 1:**

The control panel or supervisor sends a 1 to the fan coil actuator on object 15, thereby activating forced mode. The regulating value is then sent (to object 8) for the fan level selected on the basis of the threshold value set. Forced mode is terminated by means of a telegram with the value 0 to object 15, after which automatic mode is reset.

**Behaviour on sending fan value in forced mode with “Switch between auto and forced mode” = via obj. Auto/forced, forced = 0:**

**The thermostat (e.g. Thermo ICE GW 16 976 Cx) sends the regulating value for the required fan level directly (to object 8), and thereby activates forced mode. Object 15 is automatically brought back to 0.**

NB: until value 1 is sent to object 15 to activate automatic mode, the arrival of a forced control variable on object 8 is sufficient for activating forced mode.

Forced mode is terminated by means of a telegram with the value 1 to object 15, after which automatic mode is reset.

**Important with standard fan command: the forced control variable received must always be slightly higher than the threshold setting of the fan coil actuator.**

**Table 19.11: example of a forced command sent for the standard 3-speed fan**

Fan level	Values sent by Thermo ICE GW 16 976 Cx	Default threshold values for GWA9141
1	33%	10%
2	66%	40%
3	100%	70%

If fan level 2 is selected, Thermo ICE GW 16 976 Cx sends the regulating value 66%.

As the threshold value for level 2 in the fan coil actuator is set at 40%, the control variable received (66%) is clearly assigned to fan level 2 and is applied by the fan.

### 19.8.3 Time between heating and cooling and tail-off time

When switching from heating to cooling, first of all the heating valve is closed and simultaneously the *Operation for using the residual energy* (if configured) begins.

After the closure of the heating valve, the configured *Time between heating and cooling* begins.

During this time, the tail-off phase can continue. At the end of the tail-off phase, the cooling valve can be opened. In this case, the tail-off phase is interrupted if it hasn't yet ended.

If the cooling valve is not to be opened because the ambient temperature is in the dead zone, the tail-off phase can continue.

The same procedure applies when switching from cooling to heating.

As soon as the heating valve is opened, the *Warm start* can begin (if required).

#### Operation for using the residual energy:

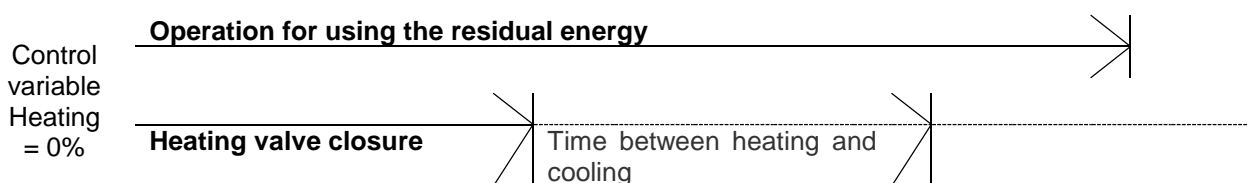

**Figure 19.9**

**Switch from heating to cooling.**

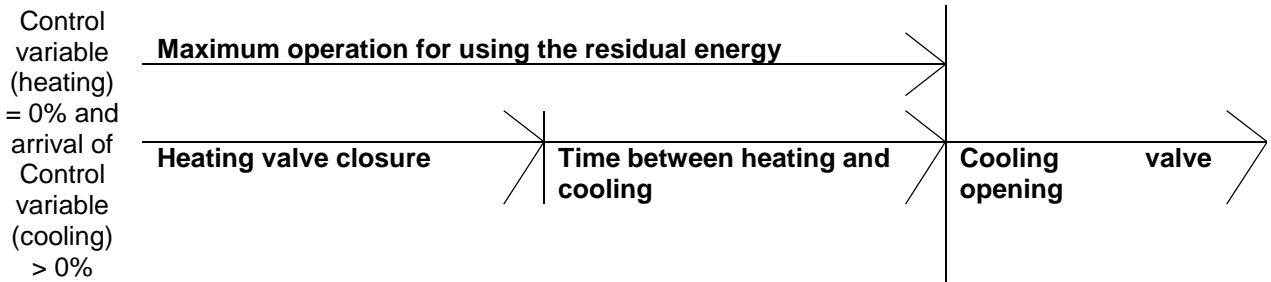

**Figure 19.10**

**Switch from cooling to heating**

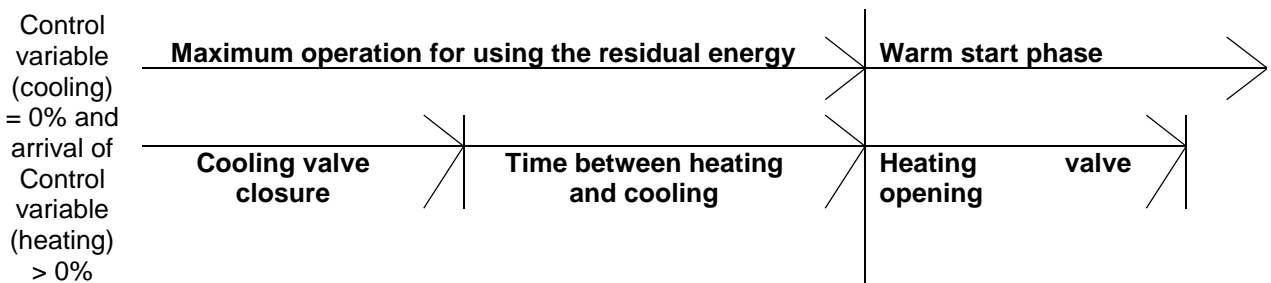

**Figure 19.11**

**19.8.4 Hysteresis**

To avoid unnecessary continuous switching between the fan levels, they are switched over with a 10% fixed hysteresis.

The next higher fan level is implemented when the control variable reaches the activation threshold.

The lower fan level is only implemented if the control variable has been reduced by the hysteresis value (see figure).

Example:

Activation threshold for fan level 1 = 10%

Activation threshold for fan level 2 = 40%

Activation threshold for fan level 3 = 70%

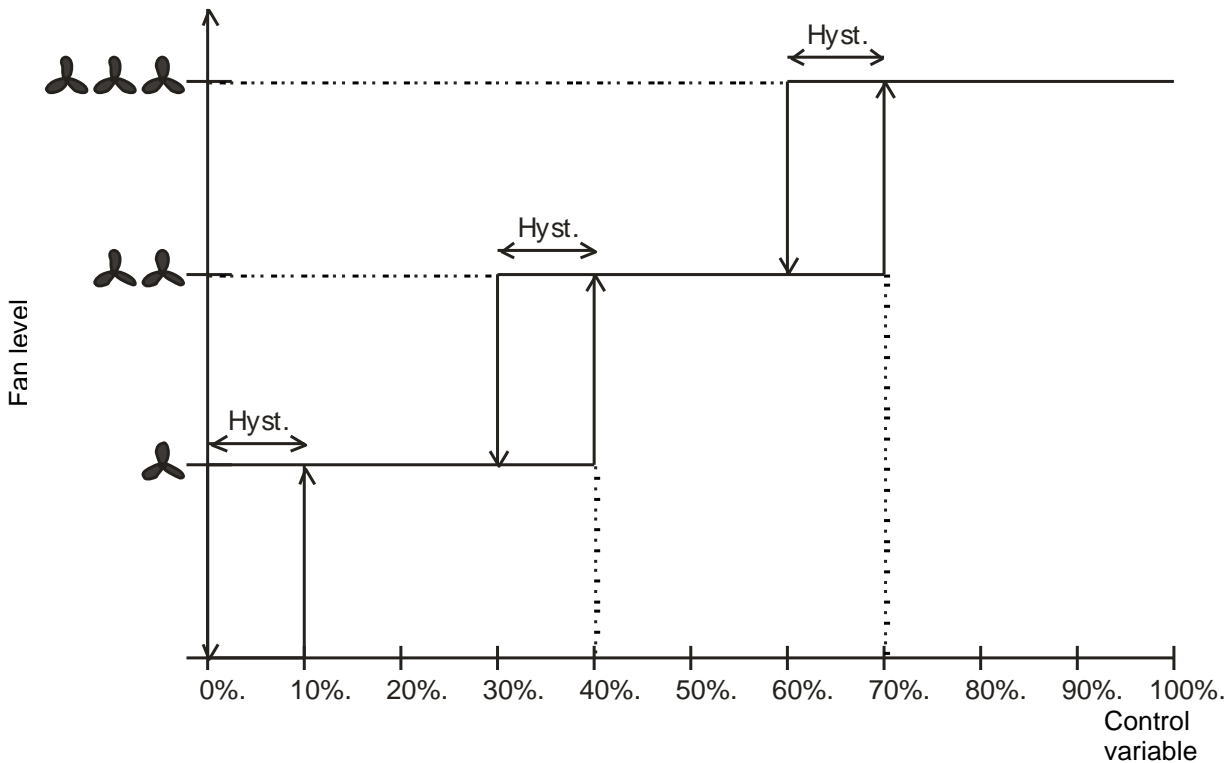

Figure 19.12

## 19.9 Regulating the temperature

### 19.9.1 Introduction

When an external regulator (e.g. GW 16 976 Cx Thermo ICE) is not used, the device can be configured as a P or PI regulator (PI regulation is preferable).

The proportional regulator (P regulator) adapts the regulating value to the deviation in static mode. The proportional integral regulator (PI regulator) is much more flexible, i.e. it regulates in dynamic mode and is quicker and more accurate.

To explain how the regulators work, in the following example the room to be heated is compared with a container.

The filling level of the container represents the ambient temperature.

The water inflow represents the radiator power.

The water outflow represent the heat loss in the room.

Our example assumes a max. inflow of 4 litres per minute, which is also the max. heating power of the radiator. This maximum power is reached with a regulating value of 100%.

This means that a regulating value of 50% would imply only half the amount of water - i.e. 2 litres per minute.

The bandwidth is 4 l.

The regulator will therefore enable the command until the real value is less than - or equal to - 17 l (21 l – 4 l).

**Task:**

- Filling quantity required:  
21 litres (= nominal value)
- When should the inflow be reduced to avoid an overflow?  
4 l below the required filling quantity, = 21 l - 4 l = 17 l (= bandwidth)
- Filling quantity assigned  
15 l (= real value)
- The losses are 1 l per minute

**19.9.2 Behaviour of the P regulator**

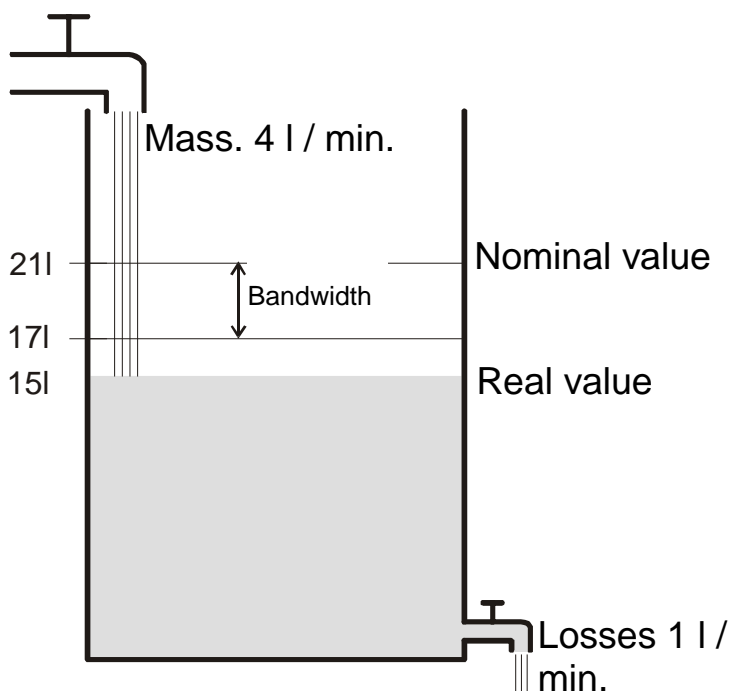

If the filling quantity is 15 l, there is a deviation of  $21\text{ l} - 5\text{ l} = 6\text{ l}$   
 Given that the real value is outside the bandwidth, the regulator will command the inflow with 100%,  
 i.e. 4 l per minute.

The inflow (= regulating value) is calculated on the basis of the deviation  
 (nominal value - real value) and the band width.  
 Regulating value = (deviation / bandwidth) x 100

The following table shows the behaviour and therefore also the limits of the P regulator.

**Table 19.11**

Filling level	Regulating value	Inflow	Losses	Filling level increase
15 l	100%	4 l / min	1 l / min	3 l / min
19 l	50%	2 l / min		1 l / min
20 l	25%	1 l / min		0 l / min

The last row shows that the filling level can't increase anymore because the water outflow is equal to the loss.  
 The result is a remaining deviation of 1 l; the nominal value can never be reached.  
 If the losses increase by 1 l, the remaining deviation will increase by the same amount and so the filling level  
 will never exceed 19 l.  
 This means that the deviation in a room will increase if the outdoor temperature falls.

### **P regulator as the temperature regulator**

The P regulator, in the case of heating adjustment, behaves exactly as explained in the previous example. The nominal temperature (21°C) will never be fully reached.

The remaining deviation will increase on the basis of the heat losses - i.e. the outdoor temperature values fall.

### **19.9.3 Behaviour of the PI regulator**

Unlike the P regulator, the PI regulator works dynamically. The regulating value does not remain unchanged, even in the case of constant deviation.

At the beginning, the PI regulator sends the same regulating value as the P regulator, but it increases according to the time in which the nominal value is not reached.

This increase is made in timed mode, using the so-called "integration time".

The regulating value is no longer changed in the moment when the nominal value and the real value are identical. This means our example shows a balance between inflow and outflow.

#### **Notes for regulating the temperature:**

A good regulation depends on the syntonisation of the bandwidth and integration time with the room to be heated.

The bandwidth influences the increase in the regulating value modification:  
large bandwidth = slight increase in regulating value modification.

The integration time influences the reaction time to the temperature modifications:  
long integration time = slow reaction.

Imperfect syntonisation may mean that the nominal value is exceeded, or that the regulator takes too long to reach the nominal value.

The best solutions are usually obtained using the standard settings or the settings via the system type.

## 20 Annex 3: Technical data of the GWA9141 device

KNX operating voltage	BUS voltage $\leq$ 8 mA
Operating voltage	100 - 240V AC
Frequency	50 - 60 Hz
Size	4 DIN modules
Assembly type	DIN profile
Type of contact	NO contact
Additional relay switching power	16A
Fan relay switching power	6A
Ambient temperature	-5°C / +45°C
Type of protection	IP 20
Protection class	II, in accordance with EN 60 730-1

Temperature regulator class	Contribution to the energy efficiency of room heating in %
V (as an ambient temperature regulator)	3.0
VI (as a regulator on the basis of the atmospheric conditions with room effect)	4.0

For more information and for the wiring, refer to the Instruction Manual of the device.

## 21 Annex 4: Communication objects

The following table summarises all the communication objects with their specific ID numbers, names and functions displayed in ETS, plus a brief description of the function and the type of Datapoint.

### Output objects

No.	Object name	Object function	Description	DPT Type
0	Actuating value heating	Sends % value	Sends the current heating valve control variable (with built-in regulator).	DPT 5.001
	Actuating value heating/cooling	Sends % value	Sends the heating/cooling valve control variable (with built-in regulator and 2-pipe system).	
	Actuating value cooling	Sends % value	Sends the current cooling valve control variable (with built-in regulator).	DPT 5.001
2	Heating status	On/Off	Sends the current heating status (1=operating; 0= not operating)	DPT 1.001
3	Cooling status	On/Off	Sends the current cooling status (1=operating; 0= not operating)	DPT 1.001
4	Fan step	Sends numerical value (1..3)	Signals the current ventilation level.	DPT 5.010
	Fan speed	Sends % value	Signals the current ventilation speed.	DPT 5.001
5	Auxiliary relay	On/Off	Sends the additional relay status	DPT 1.001
10	Fan off	On/Off	Fan status signalling	DPT 1.001
11	Fan step 1	On/Off	Signalling of level 1 active	
12	Fan step 2	On/Off	Signalling of level 2 active	
13	Fan step 3	On/Off	Signalling of level 3 active	
14	Actual value from E1	Temperature (°C)	Sends the current temperature measured by the sensor connected to E1	DPT 9.001
	Status of window contact at E1	Open/Closed	Signalling of window opening/closure status on E1	DPT 1.019
16	Drip tray monitoring status	On/Off	Signals the drip tray status	DPT 1.001
	Status of window contact at E2	Open/Closed	Signalling of window opening/closure status on E2	DPT 1.019
19	Adjust set point	Delta in K	Sends the temperature difference in relation to the nominal value (in K)	DPT 9.002
		Value in °C	Sends the absolute temperature value (new nominal value) (in °C)	DPT 9.001
20	Actuating value loss	1 = Control variable error	Signalling of non-arrival of control variable (with external regulator)	DPT 1.001
	Sensor failure	On/Off	Signals temp. sensor error if interrupted or short-circuited	DPT 1.001
24	Current operating mode	HVAC mode	Sends current HVAC mode	DPT 20.102
27	Current operating mode	Temperature °C	Sends current nominal temperature value (°C)	DPT 9.001
29	No energy medium	1 = Incorrect energy type	Signalling of error in switch between Heating and Cooling	DPT 1.001



	Heating required but heating disabled	1 = Heating blocked	Signalling of error in switch between Heating and Cooling	
	Cooling required but cooling disabled	1 = Cooling blocked	Signalling of error in switch between Heating and Cooling	
30	Fan duty time since last filter change	Time in hours	Sends the number of fan operating hours since the last filter change	DPT 7.007
31*	Change filter	1 = Change	Signalling of filter change	DPT 1.001
32	Testmode active	Enabled/Disabled	Signalling of test mode enabled/disabled	DPT 1.003

\* Also used as a reset input for the filter change status.

### Input objects

No.	Object name	Object function	Description	DPT type
0	Actuating value for fan	Value as %	Arrival of control variable for fan command	DPT 5.001
	Actuating value heating	Value as %	Arrival of control variable for heating valve	
	Actuating value heating/cooling	Value as %	Arrival of control variable for heating/cooling valve (2-pipe system)	
	Actuating value cooling	Value as %	Arrival of control variable for cooling valve	
1	Heating/Cooling	On/Off switchover (0=Heating 1= Cooling)	Arrival of switching command between heating and cooling (with 2-pipe system)	DPT 1.001
	Disable heating	1 = Heating blocked	Arrival of heating block	
	Enable cooling	1 = Cooling consent	Arrival of cooling consent	
5	Auxiliary relay	On/Off switchover	Arrival of a relay switching command	DPT 1.001
6	Lock additional ventilation	1 = block	Arrival of additional ventilation block	DPT 1.001
7	Fan lock	1 = block	Arrival of fan block	DPT 1.001
8	Fan speed in forced mode	Fan control with % value	Arrival of required % ventilation level in forcing status	DPT 5.001
	Forced fan step	Fan control with levels 0 - 3	Arrival of ventilation level with the required level number in the forcing status	DPT 5.010
9	Limitation of fan step in %	0% = Auto 1%..100% = Limit	Arrival of maximum permitted ventilation level as a %	DPT 5.001
	Limitation of fan step (1-2-3)	0 = Ventil. OFF; 1-3=max. level	Arrival of maximum permitted ventilation level as a level number.	DPT 5.010
15	Manual mode	On/Off	Deactivates/activates the forced fan contribution	DPT 1.001
	Manual mode	On/Off	Activates or deactivates the forced fan contribution	DPT 1.001
16	Drip tray monitoring status	On/Off	Arrival of the drip tray status from the external sensor	DPT 1.001
17	Dew point alarm	On/Off	Arrival of a dew point alarm	DPT 1.001

18	<i>Outdoor temperature</i>	<i>Input</i>	<i>Arrival of the outdoor temperature for nominal value adaptation</i>	DPT 9.001
21	<i>Operating mode preset</i>	<i>Mode pre-selection</i>	<i>Arrival of the HVAC mode</i>	DPT 20.102
	<i>Night mode &lt;-&gt; Standby</i>	<i>1 = Night mode</i>	<i>Arrival of Night/Standby mode activation</i>	DPT 1.001
22	<i>Presence</i>	<i>Input for presence signal</i>	<i>Arrival of presence signalling from an external sensor</i>	DPT 1.001
	<i>Comfort</i>	<i>1 = Comfort mode</i>	<i>Arrival of Comfort mode activation</i>	
23	<i>Window</i>	<i>Input for window contact</i>	<i>Arrival of the window contact status from the external sensor</i>	DPT 1.001
	<i>Frost protection</i>	<i>1 = Frost Protection mode</i>	<i>Arrival of Frost Protection/heat protection mode activation</i>	
25	<i>Manual adjustment</i>	<i>Temperature difference in K</i>	<i>Arrival of the temperature difference for variation of the nominal value</i>	DPT 9.002
26	<i>Base set point</i>	<i>Nominal temperature °C</i>	<i>Arrival of the standard nominal value</i>	DPT 9.001
28	<i>Heating/Cooling</i>	<i>On/Off (0 = Heating, 1= Cooling)</i>	<i>Switchover between Heating and Cooling</i>	DPT 1.001
	<i>Heating/Cooling</i>	<i>On/Off (1 = Heating, 0= Cooling)</i>	<i>Switchover between Heating and Cooling</i>	DPT 1.001

Punto di contatto indicato in adempimento ai fini delle direttive e regolamenti UE applicabili:  
*Contact details according to the relevant European Directives and Regulations:*

**GEWISS S.p.A. Via A.Volta, 1 IT-24069 Cenate Sotto (BG) Italy tel: +39 035 946 111 E-mail: [qualitymarks@gewiss.com](mailto:qualitymarks@gewiss.com)**



**+39 035 946 111**

8.30 - 12.30 / 14.00 - 18.00  
lunedì ÷ venerdì - monday ÷ friday



**+39 035 946 260**



**[sat@gewiss.com](mailto:sat@gewiss.com)**  
**[www.gewiss.com](http://www.gewiss.com)**