

Liquid Leakage Sensor Amplifiers K7L Series

Reliable Sensitive Liquid Sensors for Stable Detection of Liquid Chemicals with Low Conductivity and Water Leakage

- A lineup of new models compatible with Push-In Plus Terminal Block Sockets is available.
- UL listed when used with Push-In Plus Terminal Block Sockets.
- Sensor disconnection detection (K7L-AT50D□□/-UD□□).
- Models for long-distance wiring to 400 m.
- Ribbon Electrode Bands and Point Sensors available.

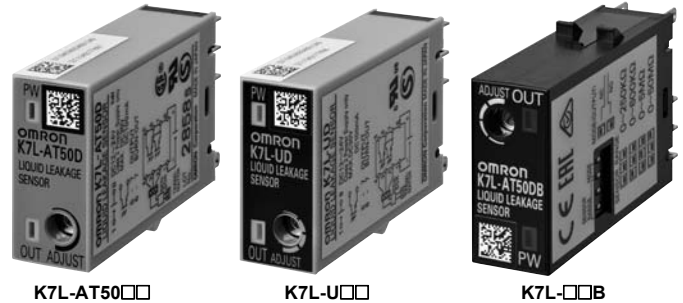

For the most recent information on models that have been certified for safety standards, refer to your OMRON website.

Model Number Legend

K7L-□□□□ □ □
(1) (2) (3)

(1)		(2)				(3)	
Symbol	Meaning	Symbol	Meaning	Output		Symbol	Meaning
				NPN connection	PNP connection (Equivalent)		
AT50	Standard wiring distance	Blank	No sensor disconnection detection	OK	OK	Blank	For Screw Terminal Block Socket
U	Long wiring distance	D	Sensor disconnection detection	OK	NG	B	For Push-In Plus Terminal Block Socket
		DP	Sensor disconnection detection Supports plus common connection	NG	OK		

Wiring distance	Disconnection detection	Socket terminals (*1)	Standards	Model
Standard usage Wiring cable: 50 m max. Sensing Bands: 10 m max.	Not supported.	Screw Terminal Block P2RF-08/-08-E	CE, SF, UL, S, CE	K7L-AT50
		Push-In Plus Terminal Block P2RF-08-PU	CE, C, UL US, UL CERTIFIED, S, CE (*2)	K7L-AT50B
	Supported.	Screw Terminal Block P2RF-08/-08-E	CE, SF, UL, S, CE	K7L-AT50D
			CE, SF, UL, S, CE	K7L-AT50DP
		Push-In Plus Terminal Block P2RF-08-PU	CE, C, UL US, UL CERTIFIED, S, CE (*2)	K7L-AT50DB
			CE, C, UL US, S, UL CERTIFIED, CE (*2)	K7L-AT50DPB
Long distance use Total Length of Wiring Cable and Sensing Bands: 400 m max.	Not supported.	Screw Terminal Block P2RF-08/-08-E	CE, C, UL US, S, CE	K7L-U
		Push-In Plus Terminal Block P2RF-08-PU	CE, C, UL US, UL CERTIFIED, S, CE (*2)	K7L-UB
	Supported.	Screw Terminal Block P2RF-08/-08-E	CE, C, UL US, S, CE	K7L-UD
			CE, C, UL US, S, CE	K7L-UDP
		Push-In Plus Terminal Block P2RF-08-PU	CE, C, UL US, UL CERTIFIED, S, CE (*2)	K7L-USB
			CE, C, UL US, S, UL CERTIFIED, CE (*2)	K7L-UDPB

*1. The applicable models of the K7L depend on the model of the Socket. If the correct Socket is not used, the K7L nameplate will be upside down.
*2. The UL listing applies only when the Sensor is used in combination with a Push-In Socket (P2RF-08-PU). By itself, the K7L is UL recognized.

K7L-AT50□/AT50D□□

Reliable Detection of a Wide Variety of Liquids Ranging from Water to Liquid Chemicals with Low Conductivity. Four Sensing Ranges Available.

- A lineup of new models compatible with Push-In Plus Terminal Block Sockets is available.
- Series of plus common connection compatible products added.
- UL listed when used with Push-In Plus Terminal Block Sockets. *1
- Provides stable detection of liquids with impedance as high as 50 MΩ using inter-electrode resistance detection. Detection of IPA and pure water possible.
- Higher noise immunity with a noise canceller circuit connected to a 3-conductor cable.
- Prevents electrode corrosion with an AC detection method.
- The power supply circuit and detection circuit are isolated, allowing several Amplifiers to be installed in the same place.
- After a disconnection is detected, operating status is held to eliminate instability due to contact of the disconnected part. *2
- Meets a variety of safety standards. *3



*1. The UL listing applies only when the Sensor is used in combination with a Push-In Plus Terminal Block Socket (P2RF-08-PU).
By itself, the K7L is UL recognized.

*2. For the K7L-AT50D.

*3. UL/CSA UL 508
CAN/CSA C22.2 No.14
CE: EMI EN 55011
 EMS EN 61000-6-2

RCM
KOSHA (S Mark) certified

Refer to *Safety Precautions* on page 10.

Features

Sensing Bands boast high degree of chemical resistance. The K7L can be used in a wide range of applications, from semiconductor production installations to food-processing equipment.

Inter-electrode Resistance Detection

Stable detection of liquids with impedances of up to 50 MΩ and common water. Four sensing ranges are available, ensuring detection suited to the application.

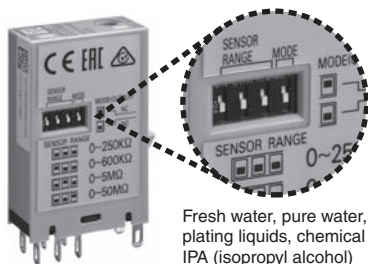

Fresh water, pure water, distilled water, plating liquids, chemical liquids, IPA (isopropyl alcohol)

AC Detection Method

The K7L internally oscillates AC signals provided to the Sensing Band, protecting the Sensing Band from electric corrosion and ensuring safe operation.

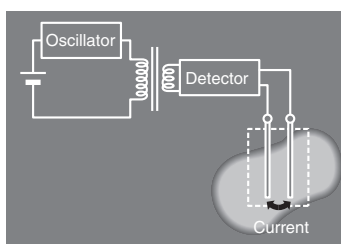

Noise Canceller Function

The K7L incorporates a noise canceller circuit that uses a 3-conductor cable, ensuring a high level of noise immunity.

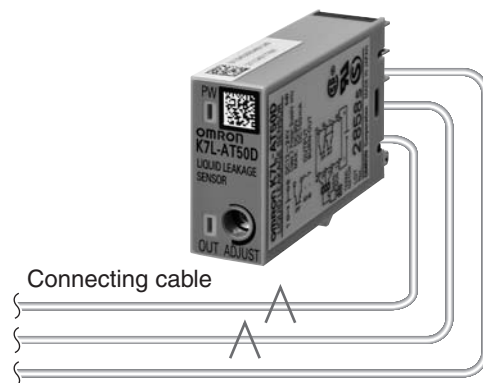

Multi-channel Applications

Isolation between the power supply circuits and sensing circuits allows multiple channels to be installed in the same location.

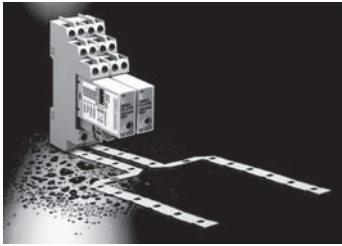

Sensing Band with Excellent Chemical Resistance

SUS316 and polyethylene are used for the Sensing Band's core and sheath to ensure high resistance to both acidic and alkaline liquids.



Liquid Leakage Detection for Measuring Baths in CMP Devices

Liquid leaked to drain pans can be detected to prevent damage to devices and cleaning irregularities for wafers.



Detection of Condensation and Liquid Leakage at Semiconductor Production Installations

Detection is also possible for condensation inside cleaning devices and liquid leaked to the surroundings.

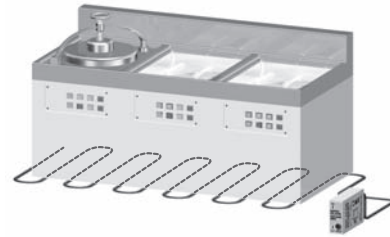

Detection of Liquid Leakage at Pipe Joints for Liquid Chemical Tanks

Liquid leakage at a pipe joint can be detected by wrapping the Sensing Band around the joint.

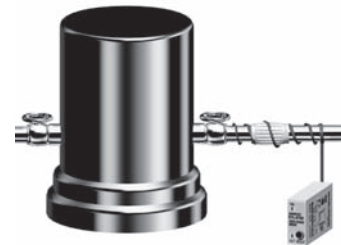

Detection of Cleaning Fluid Level for Plating Devices

The level of pure water is detected inside plating baths. High sensitivity allows high-accuracy control to prevent cleaning irregularities.

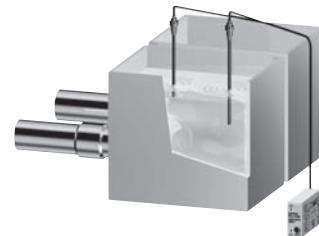

Note: Be sure to ground the baths if two or more K7L Sensors are used in the same tank in an explosion-prevention area.

Model Number Legend

K7L-AT50 □ □
(1) (2)

(1)

Symbol	Meaning	Output	
		NPN connection	PNP connection (Equivalent)
Blank	No sensor disconnection detection	OK	OK
D	Sensor disconnection detection	OK	NG
DP	Sensor disconnection detection Supports plus common connection	NG	OK

(2)

Symbol	Meaning
Blank	Ivory, Screw Terminal Block Socket
B	Black, Push-In Plus Terminal Block Socket

Note: If you want a Push-In Plus Terminal Block Socket, use the K7L-AT50□B.
(The terminal arrangement of a Push-In Plus Terminal Block Socket is upside down in comparison with a Screw Terminal Block Socket.)

Ordering Information

Product name		Model
Amplifier	Liquid Leakage Sensor Amplifier *1	K7L-AT50
		K7L-AT50B
	Liquid Leakage Sensor Amplifier with Disconnection Detection Function *1	K7L-AT50D
		K7L-AT50DP
		K7L-AT50DB
Sensors	Sensing Band	K7L-AT50DPB
		F03-15
		F03-16PE
		F03-16PT
		F03-16SF F03-16SFC
	Point Sensor (for K7L-AT50/AT50B)	F03-16PS F03-16PS-F
Mounting Brackets and Stickers	Sensing Band Stickers	F03-25
		F03-26PES
		F03-26PEN
	Point Sensor Mounting Brackets	F03-26PTN
Socket *2 (for K7L-AT50/AT50D)	Round terminals can be used.	F03-26PS
	Round terminals cannot be used.	F03-26PS-F
Socket *2 (for K7L-AT50B/AT50DB)	Push-In Plus Terminal	P2RFZ-08
Terminal Blocks		P2RFZ-08-E
Terminator		P2RF-08-PU
		F03-20
		F03-20T

*1. Accessories are provided. Check the accessories listed in the specifications for details.

*2. The applicable models of the K7L depend on the model of the Socket. If the correct Socket is not used, the K7L nameplate will be upside down.

Characteristics

Ambient temperature	Operating: -10 to +55°C
Ambient humidity	Operating: 45% to 85%
Insulation resistance	10 MΩ at 100 VDC between case and current-carrying parts
Dielectric strength	1,000 VAC at 50/60 Hz for 1 min between case and current-carrying parts
Power consumption	1 W max.
Response time	Operate: 800 ms max. Release: 800 ms max. When turning ON power: 2 s max.
Weight	Approx. 14 g

Specifications

Rated power supply voltage	12 to 24 VDC (Allowable voltage fluctuation range: 10 to 30 VDC)		
Operate resistance	0 Ω to 50 MΩ, variable Range 0: 0 to 250 kΩ Range 1: 0 to 600 kΩ Range 2: 0 to 5 kΩ Range 3: 0 to 50 kΩ Note: The range is set using the DIP switch on the side of the Sensor Amplifier. (Refer to DIP Switch Settings.) Set the corresponding pin of the DIP switch in the up position. (For range 0, set all 3 pins in the down position.) The adjuster (ADJUST) on the top of the Sensor Amplifier sets the resistance value for detection within the set range. It is factory-set to the upper limit. (Normally, the K7L can be used with the adjuster at this setting.) With any range, resistance values can be set from 0 Ω.		
Disconnection detection function *	Detection signal: 10 VDC max., 200 ms Detection time: 10 s max. Recovery: Operation is recovered by resetting the power supply.		
Release resistance	105% min. of operate resistance		
Output configuration	Open-collector transistor output with 100 mA at 30 VDC max. for both liquid leakage detection and disconnection detection. Max. 30 VDC, 100mA Note: If the rightmost pin of the DIP switch on the side of the Sensor Amplifier is set to the down position, the output turns ON when liquid is detected; if it is set to the up position, the output turns OFF when liquid is detected.		
Wiring distance	Connecting cable: 50 m max. Sensing Band length: 10 m max. Note: These values are possible on condition that a completely insulated 3-conductor VCT cable with a thickness of 0.75 mm ² and a dielectric strength of 600 V is used together with a Liquid Sensing Band specified by OMRON. (A 0.2-mm ² cable can also be used.)		
Accessories			
		Terminal Block	Screwdriver for ADJUST
		Terminator	
	K7L-AT50/AT50B	1	1
	K7L-AT50D/AT50DB/ AT50DP/AT50DPB	1	1
	K7L-AT50D-S	1	1

* For the K7L-AT50D□□.

Nomenclature and DIP Switch Settings

K7L-AT50/AT50D/AT50DP

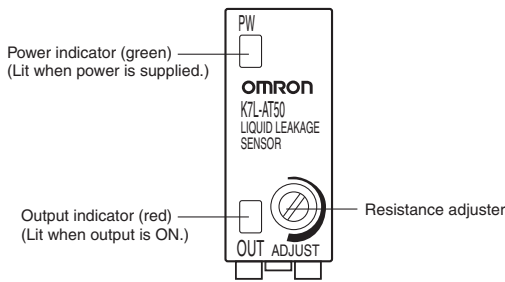

K7L-AT50B/AT50DB/AT50DPB

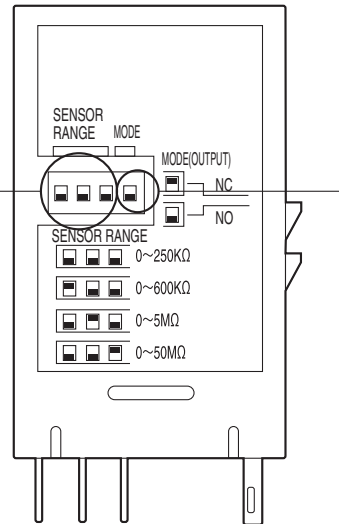
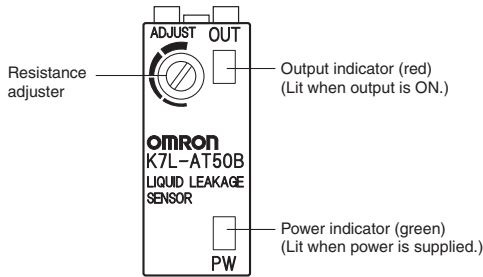

Setting Sensing Range

DIP switch	Range number	Sensing range
	Range 0	0 to 250 kΩ
	Range 1	0 to 600 kΩ
	Range 2	0 to 5 MΩ
	Range 3	0 to 50 MΩ

DIP switch	Output mode
	Output OFF when liquid leakage/ Disconnection* detected
	Output ON when liquid leakage/ Disconnection* detected

* Disconnection detection is supported only by the K7L-AT50D/AT50DB/AT50DP/AT50DPB.

Countermeasures Against Noise

Noise Canceller Function for Highly Sensitive Impedance Detection

The K7L Liquid Leakage Sensor Amplifier detects liquids with impedance as high as 50 MΩ and connects to the Sensing Band through a cable that can be extended up to 50 meters. Countermeasures against external noise are especially important for the Sensing Band and connecting cable because they pick up external noise like an antenna. The K7L incorporates the noise canceller function described below.

Connected with 3-conductor Cable that Offsets Inductive Noise

A VCT cable with three conductors (lines) is used. Line 1 is connected to the Sensing Band and line 2 is left open. Lines 1 and 2 are almost in the same position and thus will experience the same noise level. The K7L obtains the difference between these signals. This means that the noise signals in lines 1 and 2 are offset against each other and a reading for the signal, without inductive noise, can be made.

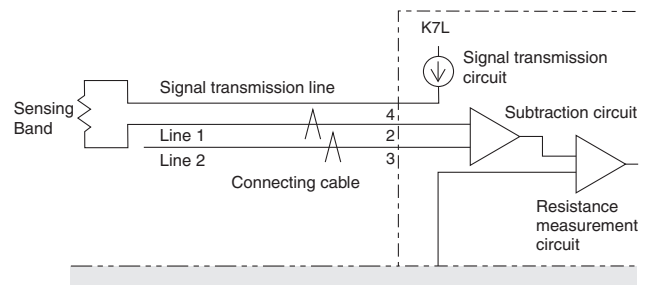

K7L-AT50□/AT50D□□

Connections

External Connections

K7L-AT50/AT50B

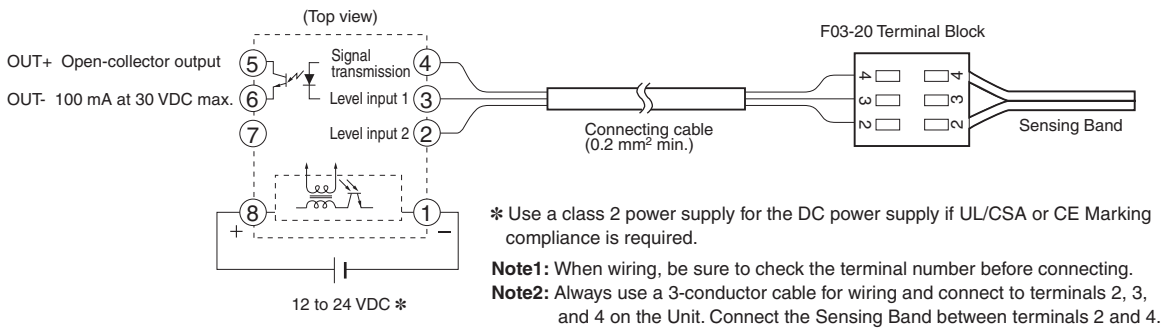

Connection Examples

Connection as an NPN Output

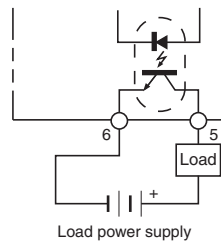

Connection as a PNP (Equivalent) Output

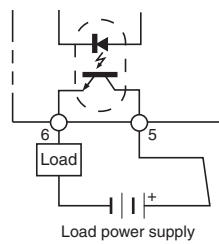

K7L-AT50D/AT50DB

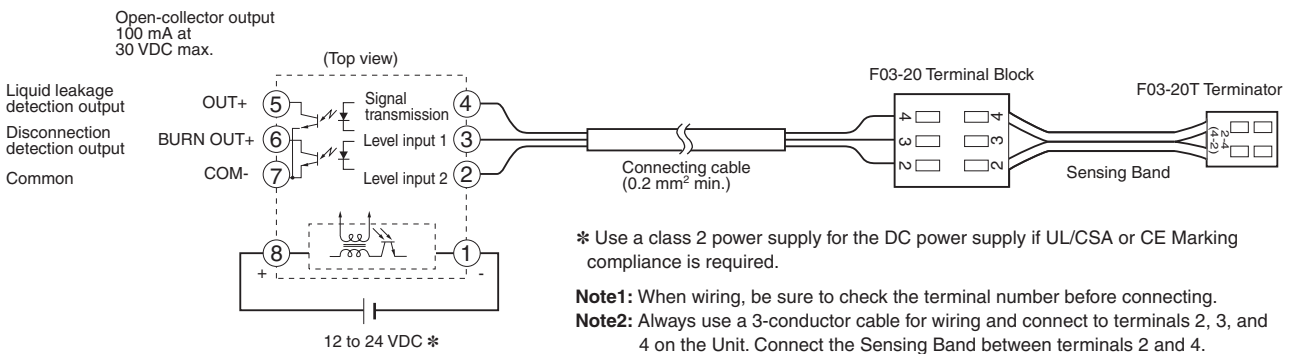

K7L-AT50DP/AT50DPB

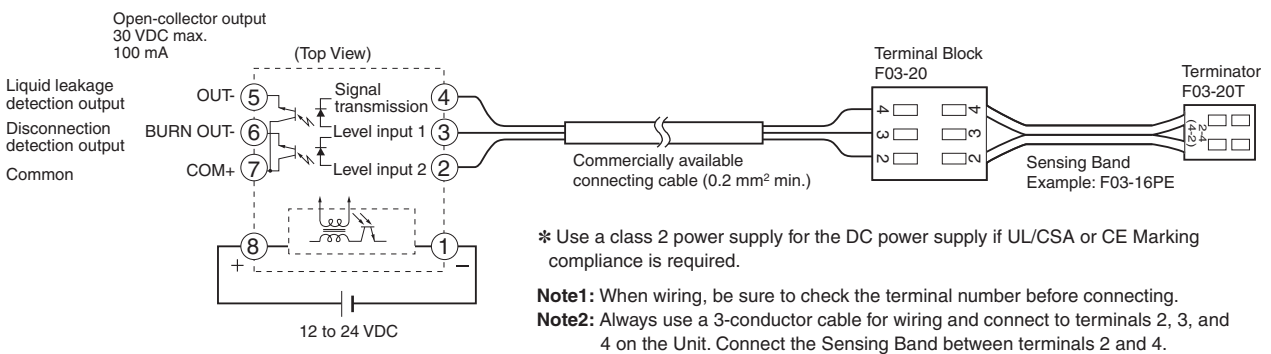

Stripping and Connecting Terminals

1. Cut into the Sensing Band approximately 4 to 6 cm in from the end as shown in the diagram below.
2. Strip away approximately the last 9 mm of the sheath to expose the core (SUS line).
3. To connect to the Terminal Block, push down the top of the terminal with a screwdriver* and insert the core from the side. More Sensing Bands can be connected simply by wiring in an arch shape.

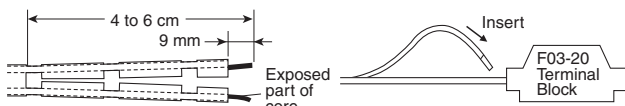

Note: When you are finished working, sufficiently confirm that there is an electrical connection.

* You can use a commercially available screwdriver, but we recommend either 1) a 210-350/01 Screwdriver or 2) a 209-132 Operating Tool from Wago. Information: [//www.wago.com](http://www.wago.com)

Disconnection detection function (K7L-AT50D/AT50DB/AT50DP/AT50DPB only)

Operation While Monitoring for Liquid Leakage

- Short-wave signals (2.5 VAC, 3.75 Hz) for liquid leakage detection are output from terminal 4 of the K7L.
- When there is no liquid leakage, the liquid leakage detection signals that are output are interrupted by the Terminator and the core of the Sensing Band will form an open loop.

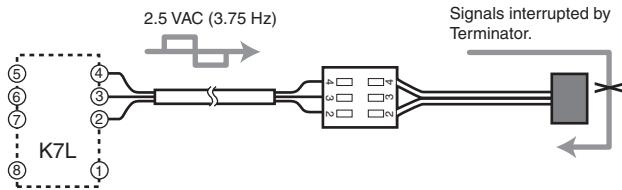

Operation at Liquid Leakage Detection

- When liquid leakage occurs within the sensing range, the liquid leakage detection signals output from terminal 4 are input to terminal 2 through the leaked liquid.
- The voltage of the input signals will vary with the resistance of the leaked liquid. This voltage is compared with the detection level set at the K7L.
- If the K7L determines from the comparison results that there is liquid leakage, the liquid leakage output will turn ON or OFF. (The output can be set to NO or NC operation.) The output indicator will turn ON and OFF together with the output. The indicator lights when the output turns ON.

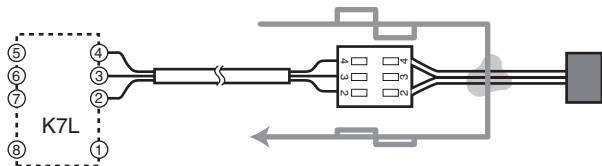

Operation While Monitoring for Disconnection

- Output of disconnection detection signals starts within 2 s of power being supplied to the K7L and is repeated at 7-s intervals.
- Disconnection signals are DC signals of 10 V max. that are output for approximately 200 ms. During this time, the K7L is in disconnection monitoring mode, i.e. it monitors for disconnections only and the liquid leakage detection signals are stopped.
- If there is no disconnection, the disconnection detection signals (10 VDC) that are output pass through the Terminator and return to the K7L.

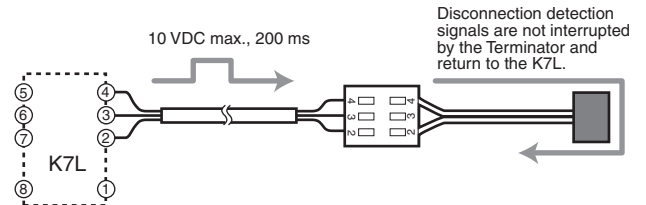

Operation at Disconnection Detection

- If there is a disconnection, the signals will be interrupted at the place where the disconnection occurred, and will not return to the K7L.
- If the signals do not return when the K7L is in disconnection monitoring mode, it will determine that a disconnection has occurred. The output indicator will flash, and the disconnection output will turn ON/OFF depending on the position of the DIP switch (right).

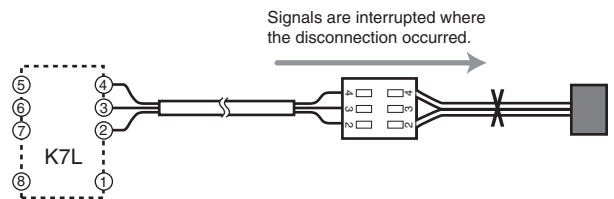

- Note:**
1. Disconnection detection is only performed between terminals 2 and 4. Therefore, be sure to connect the Sensing Band between terminals 2 and 4.
 2. The K7L will switch from liquid leakage detection to disconnection detection if either of the following conditions occur while liquid leakage is detected.
 - 2-1. Disconnection occurs between the K7L and the place where liquid is leaked.
 - 2-2. While liquid leakage is detected, disconnection occurs between the place where liquid is leaked and the Terminator (F03-20T) and, subsequently, the leaked liquid is removed (e.g., wiped up or dried).
 3. During disconnection detection, liquid leakage will not be detected. Once disconnection has been detected, reset the power supply to stop disconnection detection.

K7L-AT50□/AT50D□□

Dimensions

(Unit: mm)

Liquid Leakage Sensor Amplifier K7L-AT50/AT50D/AT50DP

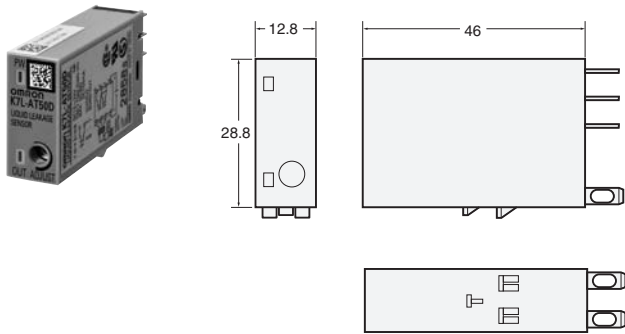

Terminal Block * F03-20

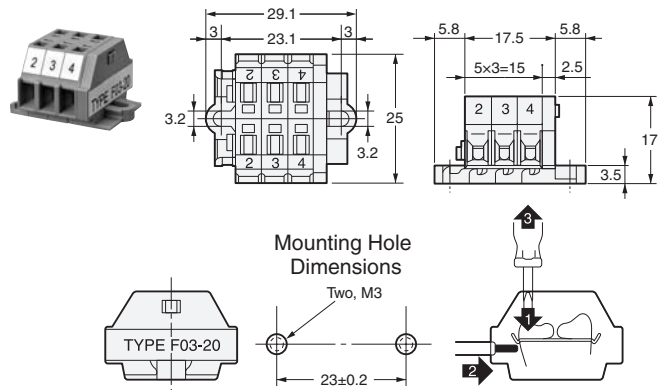

Liquid Leakage Sensor K7L-AT50B/AT50DB/AT50DPB

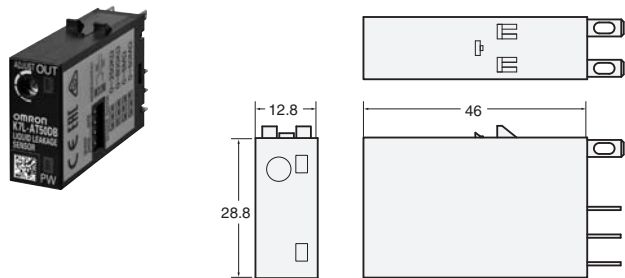

Terminator * F03-20T

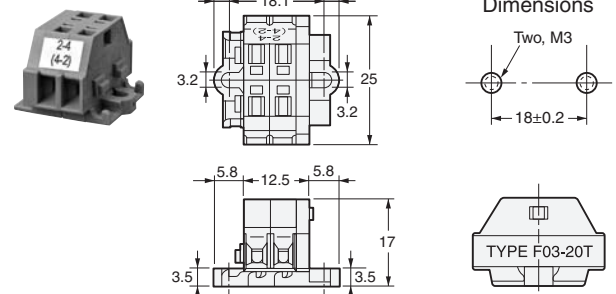

* The Terminal Block is made of nylon 66. Mount the Terminal Block in locations not subject to liquid chemicals using M3 screws.

Track-mounted Sockets *
P2RFZ-08 (Round terminals can be used.)

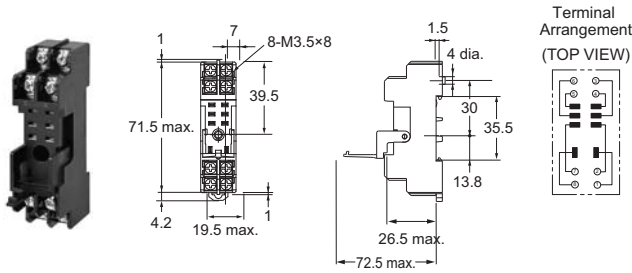

Note: Secure the Sockets with M3 screws at a torque of 0.78 to 1.18 N·m.
 * The applicable models of the K7L depend on the model of the Socket. If the correct Socket is not used, the K7L nameplate will be upside down.

Track-mounted Sockets *
P2RFZ-08-E

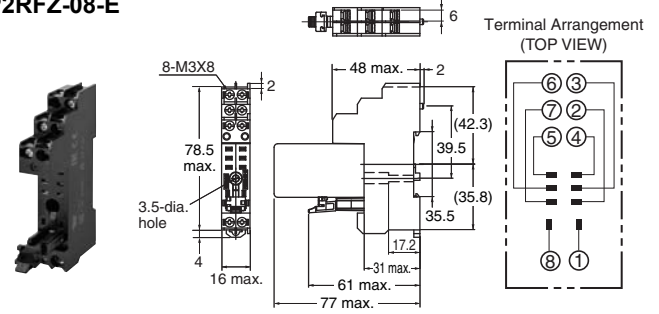

Note: Secure the Sockets with M3 screws at a torque of 0.59 to 0.88 N·m.
 * The applicable models of the K7L depend on the model of the Socket. If the correct Socket is not used, the K7L nameplate will be upside down.

Track-mounted Sockets
P2RF-08-PU

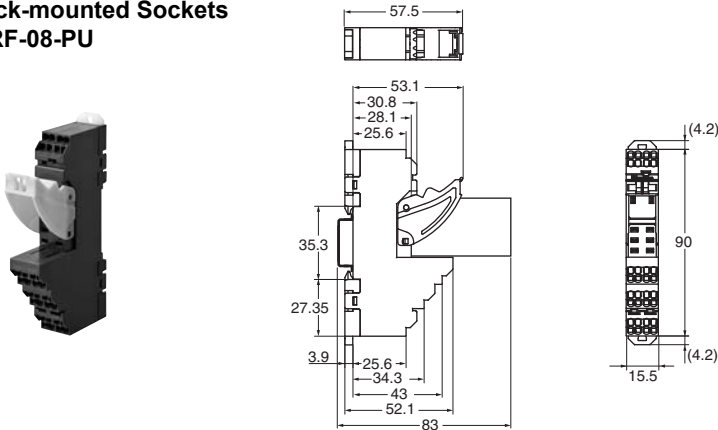

**Terminal Arrangement/
 Internal Connection Diagram
 (TOP VIEW)**

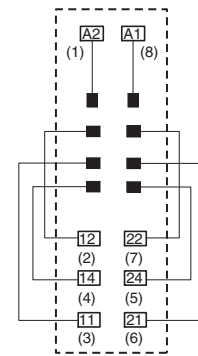

Note: The applicable models of the K7L depend on the model of the Socket. If the correct Socket is not used, the K7L nameplate will be upside down.

Note: The numbers in parentheses are traditionally used terminal numbers.

Liquid Leakage Point Sensor
F03-16PS
F03-16PS-F

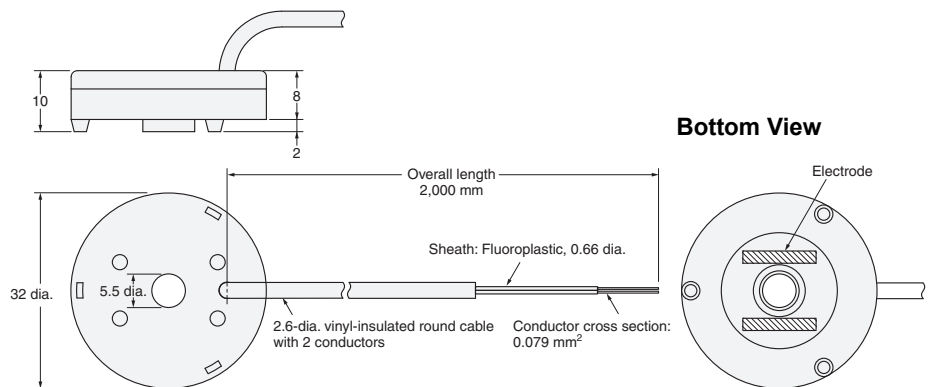

Note: Operation may not be possible with small amounts of liquid.

Point Sensor Mounting Bracket
F03-26PS

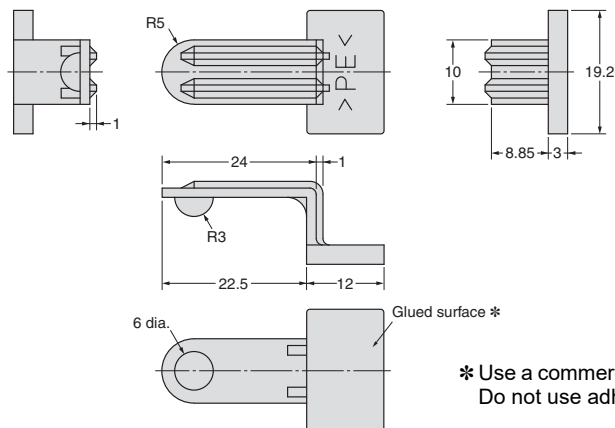
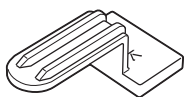

* Use a commercially available bonding agent for PVC.
 Do not use adhesive tape for securing.

Mounting Methods

Stud Screw Mounting

1. Securing the Sensor with a Nut

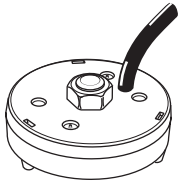

2. Securing the Sensor with a Wing Nut

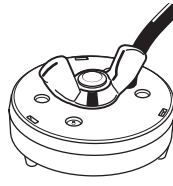

Special Bracket Mounting

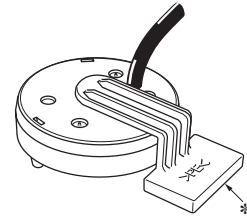

* Use a commercially available bonding agent for PVC.

Safety Precautions

Warning Indications

	WARNING Indicates a potentially hazardous situation which, if not avoided, will result in minor or moderate injury, or may result in serious injury or death. Additionally there may be significant property damage.
Precautions for Safe Use	Supplementary comments on what to do or avoid doing, to use the product safely.
Precautions for Correct Use	Supplementary comments on what to do or avoid doing, to prevent failure to operate, malfunction, or undesirable effects on product performance.

Meaning of Product Safety Symbols

	Used for general prohibitions for which is no specific symbol.
---	--

WARNING

This product is not designed or rated for ensuring safety of persons either directly or indirectly. Do not use it for such purposes.



Precautions for Safe Use

- Observe the following points to ensure safe operation.
1. Be sure to use a power supply voltage within the specified range.
 2. Do not use the product in locations subject to flammable gases or combustible objects.
 3. Insert the connection points into Sockets until the connection is locked securely.
 4. Do not short-circuit loads connected to output terminals.
 5. Be sure to connect the power supply with the correct polarity.
 6. Use a control power supply, an input power supply, and a line power supply with suitable specifications.
To use under the UL Listing specifications, use AWG20 to AWG16 solid or stranded copper wires for the line power supply.
Recommended cable: 0.75 mm² 600-V VCT 3-core, completely insulated

Precautions for Correct Use

- Do not use the Encoder under ambient conditions that exceed the ratings.
- Installation**
Attach to a panel of thickness 1 to 5 mm.
Do not install in the following locations.
1. Locations subject to shock or vibration
 2. Locations where the temperature or humidity lies outside the specified range, or where condensation is likely to occur (To detect liquids with high impedances, do not use in locations with high humidity.)
 3. Locations subject to dust
 4. Locations subject to corrosive gases (particularly sulfide and ammonia gases)
 5. Outdoors or locations subject to direct sunlight
 6. Near devices that generate strong high-frequency noise (e.g., highfrequency welding devices etc.)

Application Precautions

- You must allow sufficient leeway in ratings and performance, and provide proper fail-safe or other safety measures when using these products in any of the following applications. Be sure also to consult with your OMRON representative before actually attempting any of these applications.
1. Applications under conditions or environments not specified in user documentation
 2. Applications for nuclear control systems, railroad systems, aviation systems, vehicles, combustion systems, medical equipment, amusement machines, or safety equipment
 3. Applications that may have a serious influence on lives and property and thus require particularly attention to safety

Liquid Leakage Sensor Amplifier K7L Q&A

Some questions that are frequently asked about the K7L are given below. Use this information when selecting a model.

Q Can one K7L Amplifier be used for detection in more than one place?

A Yes.

By using Terminal Blocks to connect Sensing Bands in parallel, detection can be performed in more than place with only one K7L Amplifier.

K7L-AT50

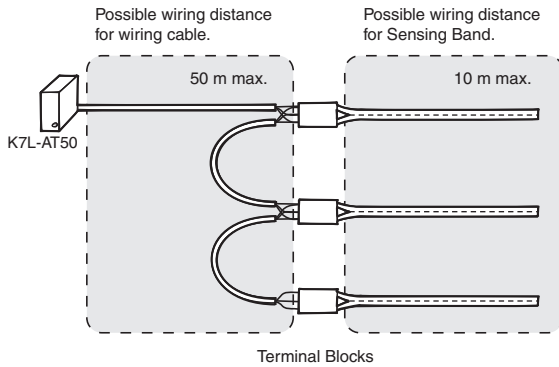

Note: 1. When wiring, be sure not to exceed the maximum possible wiring distances for both the connecting cable and the Sensing Band. Exceeding these distances may lead to faulty operation. Connect one Sensing Band to each Terminal Block.
2. Not applicable to K7L.

K7L-U

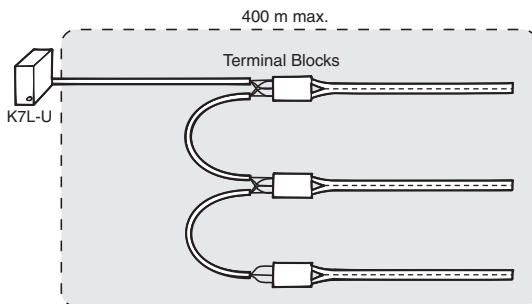

Note: 1. When wiring, be sure not to exceed the maximum possible wiring distances for both the connecting cable and the Sensing Band. Exceeding these distances may lead to faulty operation. Connect one Sensing Band to each Terminal Block.
2. Not applicable to K7L.

Q Can the K7L Amplifier be used as a replacement for the 61F-GPN-V50 or 61F-WL-CP□-NRA Water Leakage Detector?

A Yes.

Because the surge withstand capability is different, however, do not use in locations where it will be exposed to impulses and surges, such as outdoor roofs or in pump panels. Also, items such as the power supply voltage and the connection sockets are different. Check these items before application.

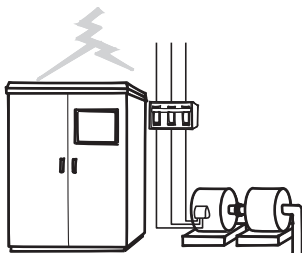

Q Can a different terminal block (e.g. a commercially available terminal block or a terminal block constructed by the user) be used instead of the one provided?

A Yes.

When using another terminal block, however, be sure to check that all the terminals are mutually isolated, and that there is no danger of ground faults in connecting cables or Sensing Bands.

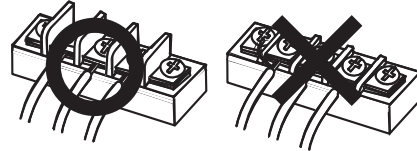

Q Can the K7L Amplifier detect pure water?

A Yes.

Even pure water, which has a resistance exceeding 10 MΩ·cm, can nearly always be detected if the K7L is used at its maximum sensitivity. This is because impurities are mixed with the water when it is leaked and the resistance drops.

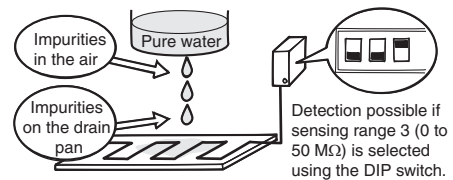

Q Can the K7L Amplifier detect oil?

A In most cases, no.

Detection may be possible if the oil contains impurities such as metal powder, as is the case with cutting oil and used engine oil. The user should confirm whether the required kind of detection is possible before application.



Liquid Leakage Sensor Amplifiers for Long-distance Wiring

K7L-U□/-UD□□

Ultra-miniature Liquid Leakage Sensor Amplifier Enables Longest Liquid Leakage Monitoring Distance in Industry

- A lineup of new models compatible with Push-In Plus Terminal Block Sockets is available.
- Series of plus common connection compatible products added.
- UL listed when used with Push-In Plus Terminal Block Sockets. *1
- Stable detection of liquids with impedance as high as 1 MΩ using inter-electrode resistance detection. Detection of chemical liquids and pure water is possible.
- Higher noise immunity with a noise canceller circuit connected to a 3-conductor cable.
- Prevents electrode corrosion with an AC detection method.
- The power supply circuit and detection circuit are isolated, allowing several Amplifiers to be installed in the same place.
- After a disconnection is detected, operating status is held to eliminate instability due to contact of the disconnected part. *2
- Meets a variety of safety standards. *3



- *1. The UL listing applies only when the Sensor is used in combination with a Push-In Socket (P2RF-08-PU). By itself, the K7L is UL recognized.
- *2. For the K7L-UD.
- *3. UL: UL 508
CAN/CSA C22.2 No.14
CE: EMI EN 55011
EMS EN 61000-6-2
RCM
KOSHA (S Mark) certified

Refer to *Safety Precautions* on page 19.

Features

A total distance of 400 m is achieved for cable and Sensing Band to minimize leakage damage.

Greatly expands the detection area.

A total distance of 400 m for the cable and Sensing Band extends the wiring distance by approximately 7 times compared with our previous models.

Industry's longest

Total length of cable and Sensing Band is 400 m max.

* According to an OMRON survey

Detects broken wires.

Broken wire signal

Detects broken wires all the way from the main unit to the tip of the Sensing Band. This enhances reliability in long-distance wiring applications.

Breaks in wiring

Terminal Block

Sensing Band

Terminator

Cable

Helps to downsize gang-mounted panels.

The extremely compact size, with a width of only 16 mm, helps to save panel size when mounting several Units together.

Only 192 mm for 12 Units

Features a Noise Canceller

A noise canceling circuit employing a three-conductor cable enables stable liquid leakage detection with excellent noise resistance.

Connecting cable

Application Examples

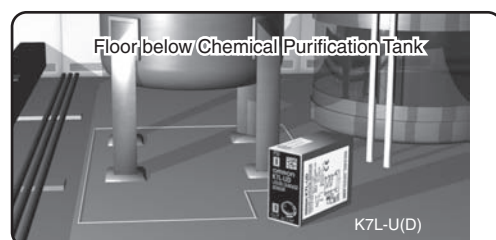
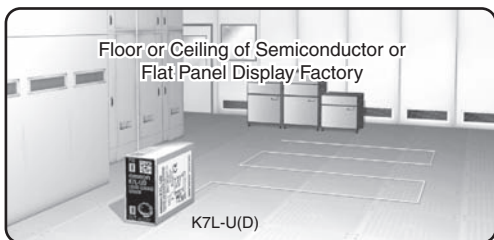

Model Number Legend

K7L-U □ □
(1) (2)

(1)

Symbol	Meaning	Output	
		NPN connection	PNP connection (Equivalent)
Blank	No sensor disconnection detection	OK	OK
D	Sensor disconnection detection	OK	NG
DP	Sensor disconnection detection Supports plus common connection	NG	OK

(2)

Symbol	Meaning
Blank	Ivory, Screw Terminal Block Socket
B	Black, Push-In Plus Terminal Block Socket

Note: If you want a Push-In Plus Terminal Block Socket, use the K7L-U□B. (The terminal arrangement of a Push-In Plus Terminal Block Socket is upside down in comparison with a Screw Terminal Block Socket.)

Ordering Information

Product name		Model
Amplifier	Liquid Leakage Sensor Amplifier #1	K7L-U
		K7L-UB
	Liquid Leakage Sensor Amplifier with Disconnection Detection Function #1	K7L-UD
		K7L-UDP
		K7L-UDB
		K7L-UDPB
Sensors	Sensing Band	F03-15
		F03-16PE
		F03-16PT
		F03-16SF F03-16SFC
	Point Sensor (for K7L-U/UB)	F03-16PS
		F03-16PS-F
Mounting Brackets and Stickers	Sensing Band Stickers	F03-25
		F03-26PES
		F03-26PEN
		F03-26PTN
	Point Sensor Mounting Brackets	F03-26PS
Track-mounted Socket #2 (for K7L-U/UD)	Round terminals can be used.	P2RFZ-08
	Round terminals cannot be used.	P2RFZ-08-E
Track-mounted Socket #2 (for K7L-UB/UDB)	Push-In Plus Terminal	P2RF-08-PU
Terminal Blocks		F03-20
Terminator		F03-20T

*1. Accessories are available. Check the ratings for details.

*2. The applicable models of the K7L depend on the model of the Socket. If the correct Socket is not used, the K7L nameplate will be upside down.

Characteristics

Ambient temperature	Operating: -10 to 55°C
Ambient humidity	Operating: 45% to 85%
Insulation resistance	10 MΩ at 100 VDC between case and current-carrying parts
Dielectric strength	1,000 VAC at 50/60 Hz for 1 min between case and current-carrying parts
Power consumption	1 W max.
Response time	Operate: 800 ms max. Release: 800 ms max. Startup time after power ON: 2 s max.
Weight	Approx. 14 g

Ratings

Rated power supply voltage	12 to 24 VDC (Allowable voltage fluctuation range: 10 to 30 VDC)																
Operate resistance	0 to 1 MΩ variable Note: The adjuster (ADJUST) on the top of the Sensor Amplifier sets the resistance for detection within the setting range. It is factory-set to the upper limit. (Normally, the K7L can be used with the adjuster at this setting.)																
Disconnection detection function #	Detection signal: 10 VDC max., 200 ms Detection time: 10 s max. Recovery: Operation is recovered by resetting the power supply.																
Release resistance	105% min. of operate resistance																
Output configuration	Open-collector transistor output with 100 mA at 30 VDC max. for both liquid leakage detection and disconnection detection. Note: If the rightmost pin of the DIP switch on the side of the Sensor Amplifier is set to the down position, the output turns ON when liquid is detected; if it is set to the up position, the output turns OFF when liquid is detected.																
Vibration resistance	10 to 150 Hz, 0.1-mm single amplitude with 15-m/s ² acceleration for 8 minutes 10 times each in X, Y, and Z directions																
Shock resistance	150 m/s ² 3 times each in six directions on 3 axes																
Wiring distance	Wiring cable } Total: 400 m max. Sensing Band } Note: These values are possible on the condition that a completely insulated 3-conductor VCT cable with a thickness of 0.75 mm ² and a dielectric strength of 600 V is used together with the Liquid Sensing Band specified by OMRON. (A 0.2-mm ² cable can also be used.)																
Accessories	<table border="1"> <thead> <tr> <th>Product Name</th> <th>Terminal Block</th> <th>Screwdriver for ADJUST</th> <th>Terminator</th> </tr> </thead> <tbody> <tr> <td>Model</td> <td>F03-20</td> <td>---</td> <td>F03-20T</td> </tr> <tr> <td>K7L-U/UB</td> <td>1</td> <td>1</td> <td>---</td> </tr> <tr> <td>K7L-UD/UDB/UDP/UDPB</td> <td>1</td> <td>1</td> <td>1</td> </tr> </tbody> </table>	Product Name	Terminal Block	Screwdriver for ADJUST	Terminator	Model	F03-20	---	F03-20T	K7L-U/UB	1	1	---	K7L-UD/UDB/UDP/UDPB	1	1	1
	Product Name	Terminal Block	Screwdriver for ADJUST	Terminator													
	Model	F03-20	---	F03-20T													
	K7L-U/UB	1	1	---													
K7L-UD/UDB/UDP/UDPB	1	1	1														

* For the K7L-UD□□.

Nomenclature and DIP Switch Settings

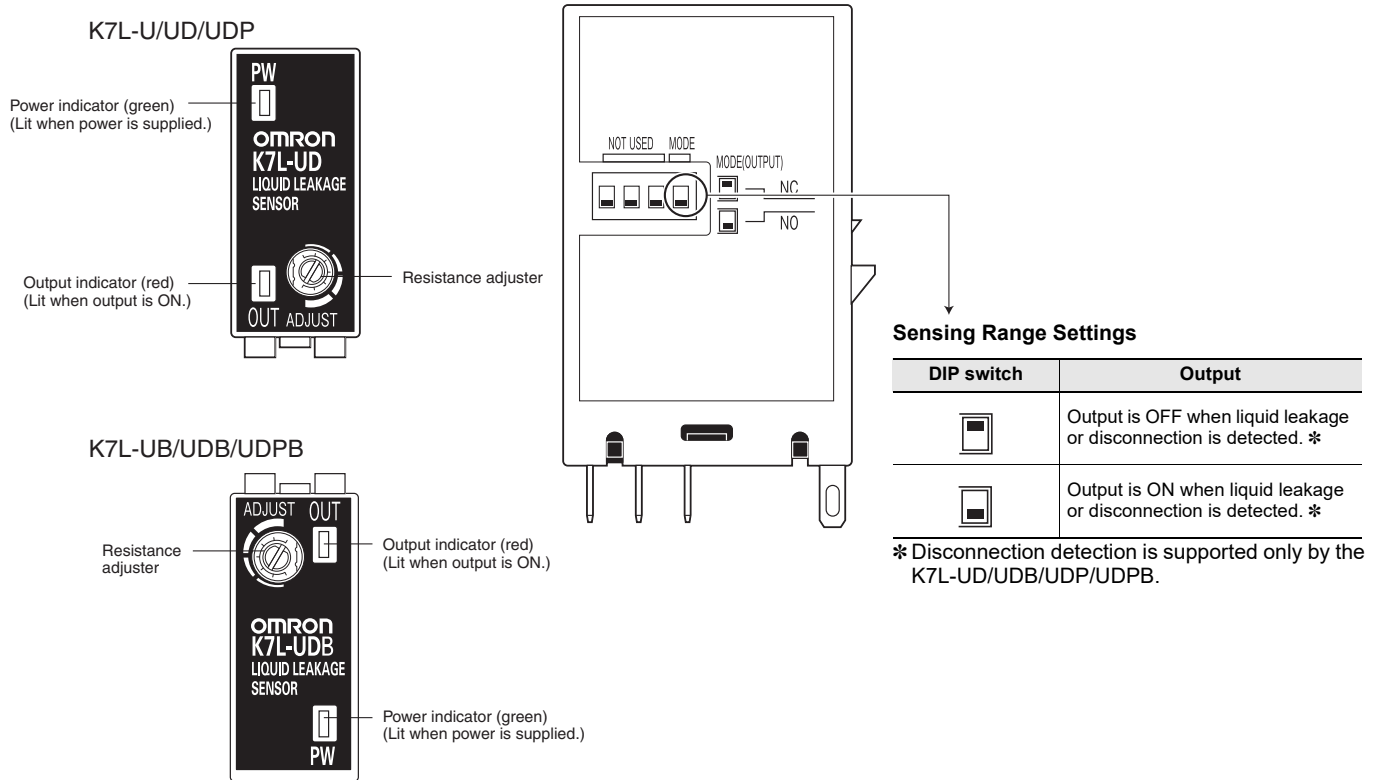

Noise Countermeasures (Common)

Noise Canceller Function for Highly Sensitive Impedance Detection

The K7L-U/UB Liquid Leakage Sensor Amplifier detects liquids with impedance as high as 1 MW and connects to the Sensing Band through a cable that can be extended up to 400 meters. Countermeasures against external noise are especially important for the Sensing Band and connecting cable because they pick up external noise like an antenna. The K7L incorporates the noise canceller function described below.

Connected with 3-conductor Cable that Offsets Inductive Noise

A VCT cable with three conductors (lines) is used as shown in the diagram. Line 1 is connected to the Sensing Band and line 2 is left open. Lines 1 and 2 are almost in the same position and thus will experience the same noise level. The K7L detects the difference between these signals (including noise). This means that the noise signals in lines 1 and 2 are offset against each other and a reading for the signal, without inductive noise, can be made.

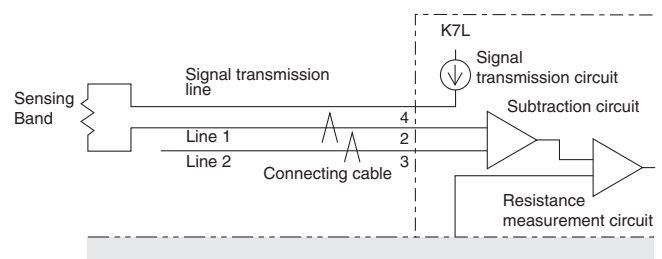

Connections

K7L-U/UB

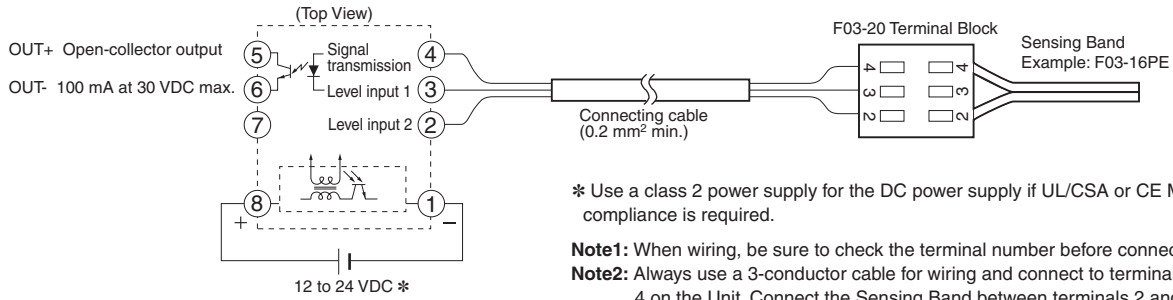

Output Circuit Examples

The NPN open-collector output of the K7L-U/UB is isolated from the internal circuits by a photocoupler, so you can use either an NPN open-collector output or a PNP (equivalent) output.

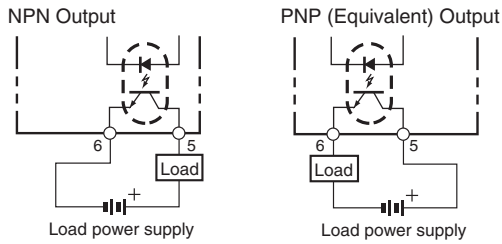

K7L-UD/USB

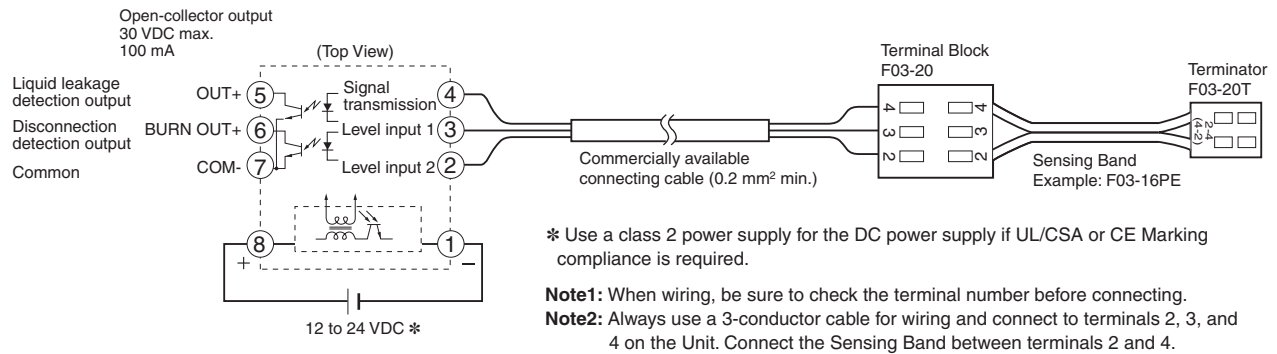

K7L-UDP/UDPB

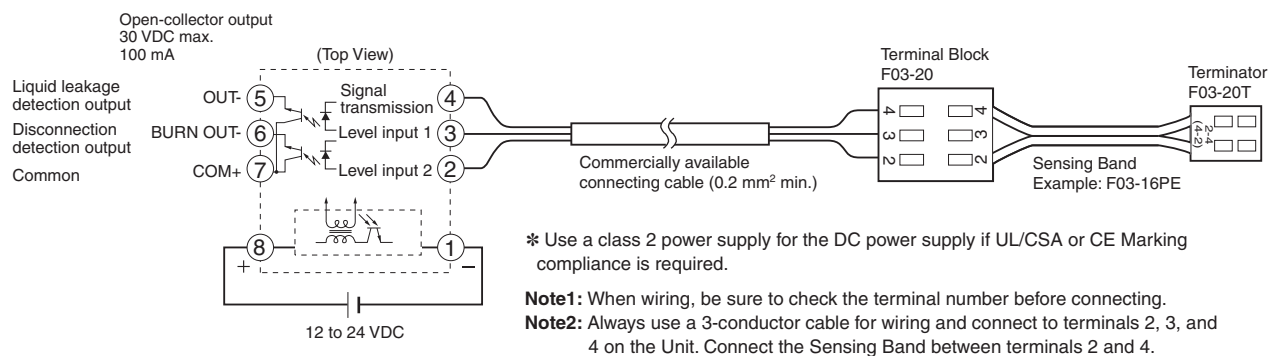

Disconnection Detection Function (K7L-UD/UDB/UDP/UDPB only)

Operation While Monitoring for Liquid Leakage

- Short-wave signals (2.5 VAC, 3.75 Hz) for liquid leakage detection are output from terminal 4 of the K7L.
- When there is no liquid leakage, the liquid leakage detection signals that are output are interrupted by the Terminator and the core of the Sensing Band will form an open loop.

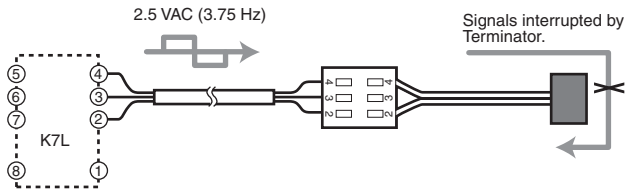

Operation at Liquid Leakage Detection

- When liquid leakage occurs within the sensing range, the liquid leakage detection signals output from terminal 4 are input to terminal 2 through the leaked liquid.
- The voltage of the input signals will vary with the resistance of the leaked liquid. This voltage is compared with the detection level set at the K7L.
- As a result of the comparison, if the K7L determines that liquid leakage has occurred, the K7L's output LED will light, and the liquid detection output will either turn ON or OFF.

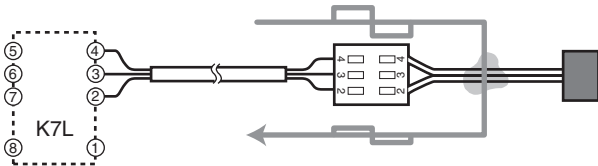

Operation While Monitoring for Disconnection

- Output of disconnection detection signals starts within 2 s after power is supplied to the K7L and is repeated at approximately 7-s intervals.
- Disconnection signals are DC signals of 10 V max. that are output for approximately 200 ms. During this time, the K7L is in disconnection monitoring mode, i.e. it monitors for disconnections only and the liquid leakage detection signals are stopped.
- If there is no disconnection, the disconnection detection signals (10 VDC) that are output pass through the Terminator and return to the K7L. The K7L takes this as normal, i.e., there is no disconnection.

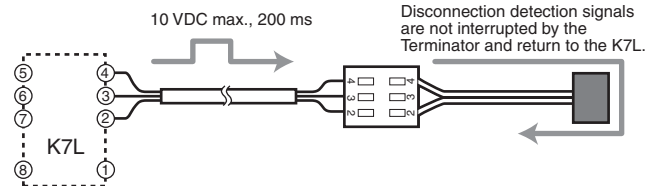

Operation at Disconnection Detection

- If there is a disconnection, the signals will be interrupted at the place where the disconnection occurred, and will not return to the K7L.
- If the signals do not return, it will determine that a disconnection has occurred. The output indicator will flash, and the disconnection output will turn ON/OFF.

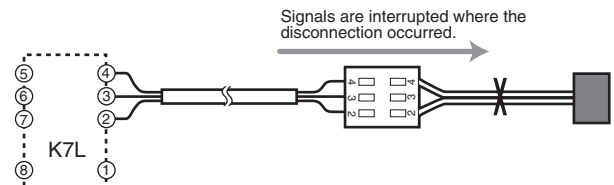

- Note:**
1. Disconnection detection is only performed between terminals 2 and 4. Therefore, be sure to connect the Sensing Band between terminals 2 and 4.
 2. The K7L will switch from liquid leakage detection to disconnection detection if either of the following conditions occur while liquid leakage is detected.
 - 2-1. Disconnection occurs between the K7L and the place where liquid is leaked.
 - 2-2. While liquid leakage is detected, disconnection occurs between the place where liquid is leaked and the Terminator (F03-20T) and, subsequently, the leaked liquid is removed (e.g., wiped up or dried).
 3. During disconnection detection, liquid leakage will not be detected. Once disconnection has been detected, reset the power supply to stop disconnection detection.

Surges

Use in conjunction with a 61F-03B Surge Suppressor Unit in environments exposed to surges.

Install the Surge Suppressor Unit near the K7L. The surge suppression may not be sufficient if the Surge Suppressor Unit is installed near the Sensing Band.

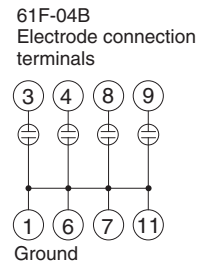
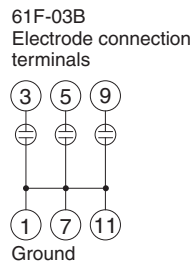
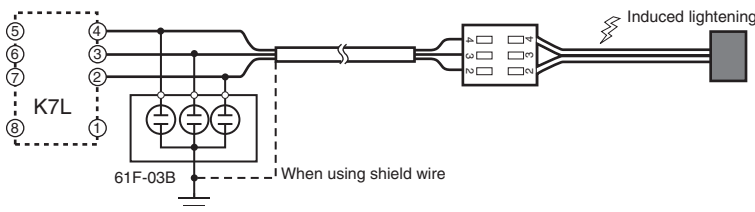

Note: For details on Surge Suppressor Units, refer to your OMRON website.

Dimensions

Liquid Leakage Sensor Amplifier K7L-U/-UD/-UDP

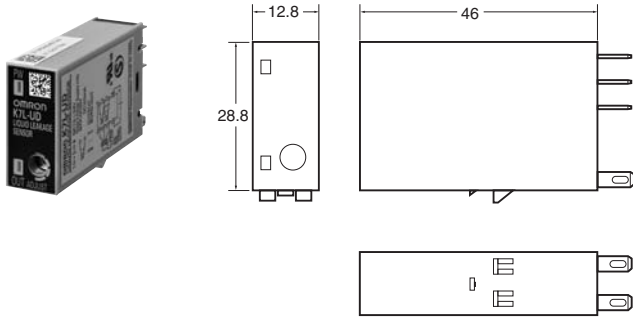

Terminal Block * F03-20

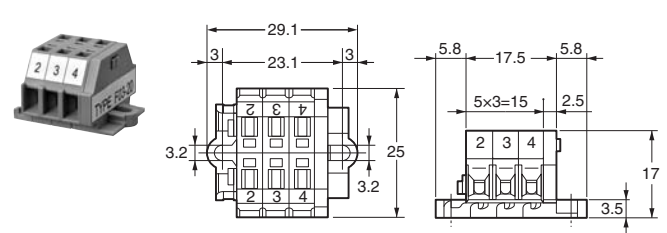

Liquid Leakage Sensor Amplifier K7L-UB/-UDB/-UDPB

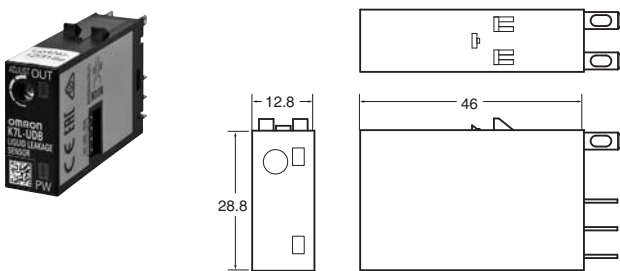

Terminator * F03-20T

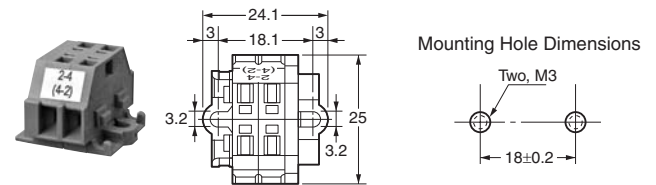

Track-mounted Sockets * P2RFZ-08 (Round terminals can be used.)

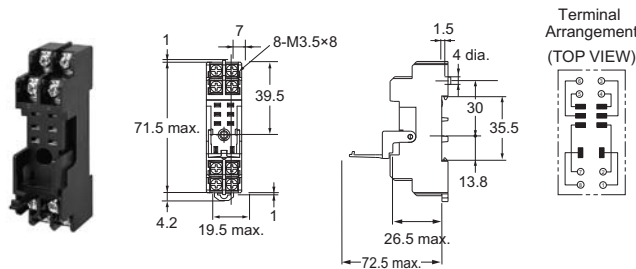

Note: The applicable models of the K7L depend on the model of the Socket. If the correct Socket is not used, the K7L nameplate will be upside down.

Track-mounted Sockets * P2RFZ-08-E

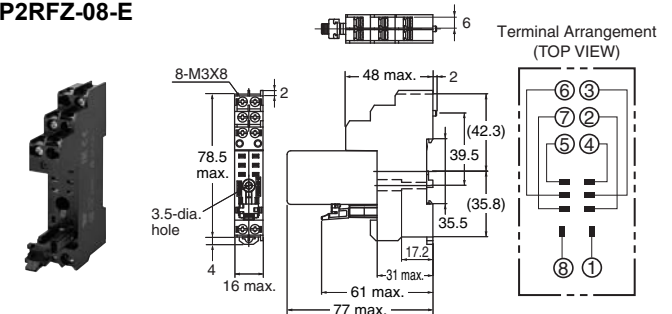

Note: The applicable models of the K7L depend on the model of the Socket. If the correct Socket is not used, the K7L nameplate will be upside down.

Front-mounting Sockets P2RF-08-PU

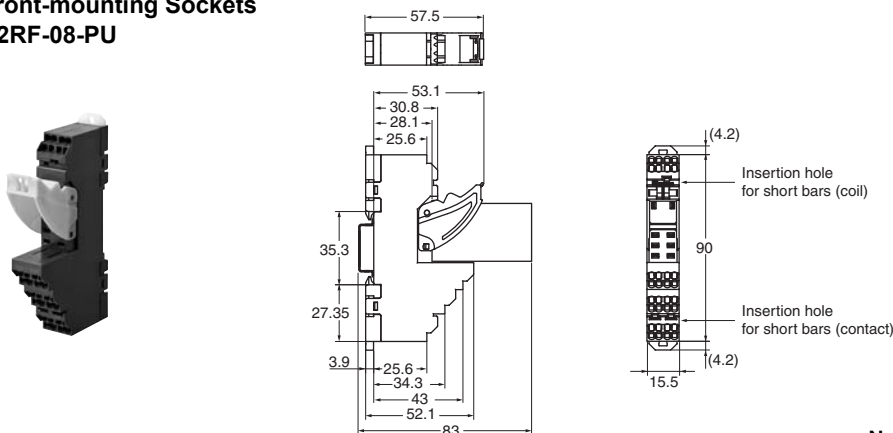

Note: The applicable models of the K7L depend on the model of the Socket. If the correct Socket is not used, the K7L nameplate will be upside down.

Terminal Arrangement/ Internal Connection Diagram (TOP VIEW)

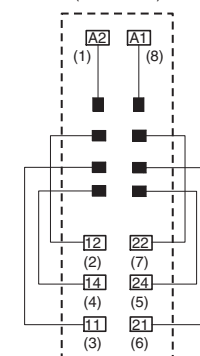

Note: 1. The numbers in parentheses are traditionally used terminal numbers.
2. Insert the short bar into only the A1 or A2 side.

* The Terminal Block is made of nylon 66. Mount the Terminal Block in locations not subject to liquid chemicals using M3 screws.

Liquid Leakage Point Sensor
F03-16PS
F03-16PS-F

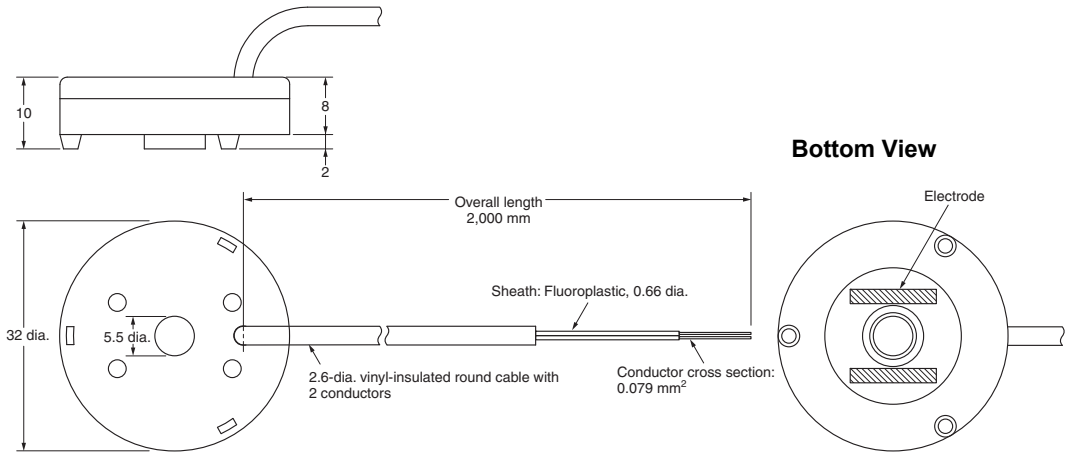

Note: Operation may not be possible with small amounts of liquid.

Point Sensor Mounting Bracket
F03-26PS

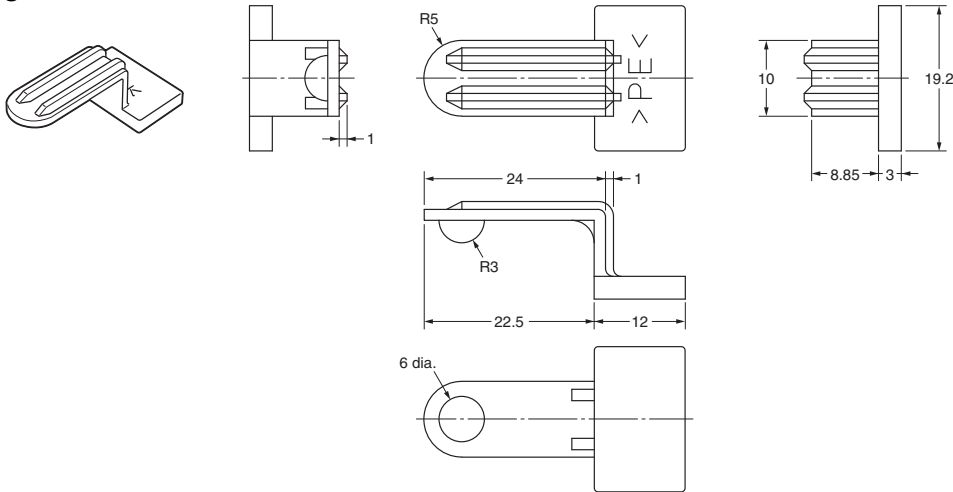

* Secure the Sockets with M3 screws at a torque of 0.78 to 1.18 N·m.

Safety Precautions

Warning Indications

 WARNING	Indicates a potentially hazardous situation which, if not avoided, will result in minor or moderate injury, or may result in serious injury or death. Additionally there may be significant property damage.
Precautions for Safe Use	Supplementary comments on what to do or avoid doing, to use the product safely.
Precautions for Correct Use	Supplementary comments on what to do or avoid doing, to prevent failure to operate, malfunction, or undesirable effects on product performance.

Meaning of Product Safety Symbols

	Used for general prohibitions for which is no specific symbol.
---	--

WARNING

This product cannot be used as a detection device for protecting human life.



Precautions for Safe Use

Observe the following points to ensure safe operation.

1. Be sure to use a power supply voltage within the specified range. Not doing so may result in burning or malfunction.
2. Do not use the product in locations subject to flammable gases or combustible objects. Doing so may result in fire.
3. Insert the connection points into Sockets until the connection is locked securely. Not doing so may result in burning or malfunction.
4. Do not short-circuit loads connected to output terminals. Doing so may result in burning.
5. Be sure to connect the power supply with the correct polarity. Not doing so may result in malfunction.
6. Use a control power supply, an input power supply, and a line power supply with suitable specifications.
To use under the UL Listing specifications, use AWG20 to AWG16 solid or stranded copper wires for the line power supply.
Recommended cable: 0.75 mm² 600-V VCT 3-core, completely insulated

Precautions for Correct Use

Installation

Attach to a panel of thickness 1 to 5 mm.

Do not install in the following locations.

1. Locations subject to shock or vibration
2. Locations where the temperature or humidity lies outside the specified range, or where condensation is likely to occur (To detect liquids with high impedances, do not use in locations with high humidity.)
3. Locations subject to dust
4. Locations subject to corrosive gases (particularly sulfide and ammonia gases)
5. Outdoors or locations subject to direct sunlight
6. Near devices that generate strong high-frequency noise (e.g., high-frequency welding devices etc.)

Application Precautions

You must allow sufficient leeway in ratings and performance, and provide proper fail-safe or other safety measures when using these products in any of the following applications. Be sure also to consult with your OMRON representative before actually attempting any of these applications.

1. Applications under conditions or environments not specified in user documentation
2. Applications for nuclear control systems, railroad systems, aviation systems, vehicles, combustion systems, medical equipment, amusement machines, or safety equipment
3. Applications that may have a serious influence on lives and property and thus require particularly attention to safety

Liquid Leakage Sensor Amplifier K7L FAQs

Some questions that are frequently asked about the K7L are given below. Use this information when selecting a model.

Q Can one K7L Amplifier be used for detection in more than one place?

A Yes.

By using Terminal Blocks to connect Sensing Bands in parallel, detection can be performed in more than place with only one K7L Amplifier.

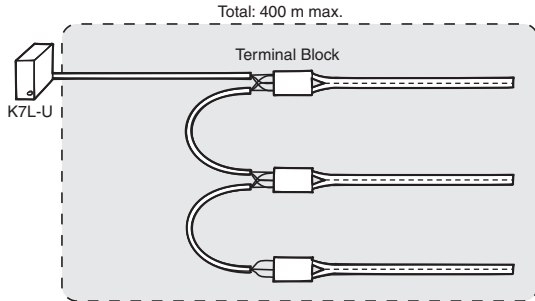

- Note:**
1. When wiring, be sure not to exceed the maximum possible wiring distances for both the connecting cable and the Sensing Band. Exceeding these distances may lead to faulty operation. Connect one Sensing Band to each Terminal Block.
 2. Not applicable to the K7L.

Q Can the K7L Amplifier be used as a replacement for the 61F-GPN-V50 or 61F-WL-CP□-NRA Water Leakage Detector?

A Yes.

Because the surge withstand capability is different, however, do not use in locations where it will be exposed to impulses and surges, such as outdoor roofs or in pump panels. Also, items such as the power supply voltage and the connection sockets are different. Check these items before application.

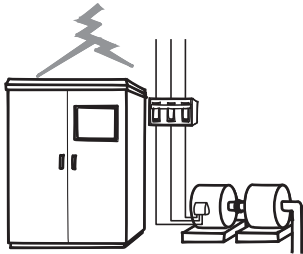

Q Can a different terminal block (e.g. a commercially available terminal block or a terminal block constructed by the user) be used instead of the one provided?

A Yes.

When using another terminal block, however, be sure to check that all the terminals are mutually isolated, and that there is no danger of ground faults in connecting cables or Sensing Bands.

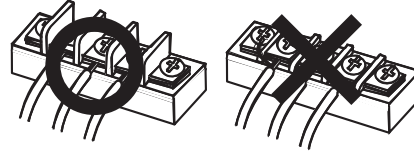

Q Can the K7L Amplifier detect pure water?

A Yes.

Even pure water, which has a resistance exceeding 10 MWΩ-cm, can nearly always be detected if the K7L is used at its maximum sensitivity. This is because impurities are mixed with the water when it is leaked and the resistance drops.

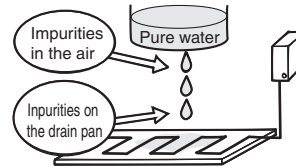

Q Can the K7L Amplifier detect oil?

A No.



Sensing Band/Point Sensor

 Indicates models that allow free cutting.

F03-16PE Liquid Leakage Sensing Band



- SUS316 used for core and polyethylene used for sheath to ensure high resistance to both acidic and alkaline liquids.
- Sensing Band Stickers that use the same material as the Sensing Band's insulating resin are available in 2 types: adhesive-tape type and screw type.

Ordering Information

Name	Model	
Liquid Leakage Sensing Band	1 m	F03-16PE 1M
	2 m	F03-16PE 2M
	5 m	F03-16PE 5M
	10 m	F03-16PE 10M
	15 m	F03-16PE 15M
	20 m	F03-16PE 20M
	25 m	F03-16PE 25M
	30 m	F03-16PE 30M
	40 m	F03-16PE 40M
	50 m	F03-16PE 50M
	100 m	F03-16PE 100M
Sensing Band Stickers (adhesive tape)	F03-26PES *	
Sensing Band Stickers (screw)	F03-26PEN *	

Note: 1. Specify the cable length for F03-16PE from the list above.
2. The cables can be cut.
* 30 Stickers per set

Specifications

Sheath	Polyethylene
Core	SUS316 stainless steel
Ambient operating temperature	-10 to 55°C
Weight	Approx. 16 g (1 m)

Dimensions Sensing Band F03-16PE

(Unit: mm)

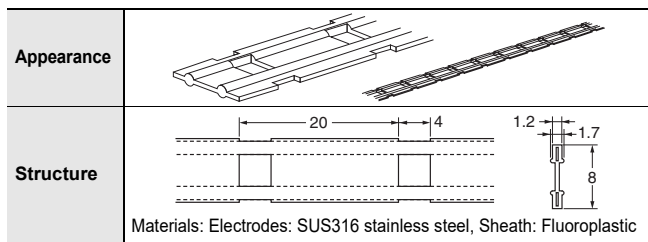

Sensing Band Stickers F03-26PEN (screws)

(Unit: mm)

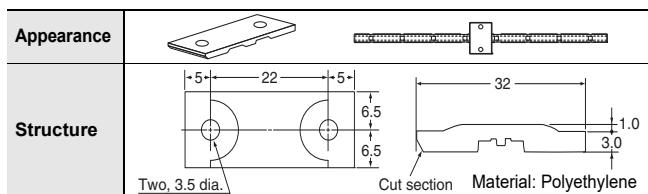

F03-26PES (adhesive tape)

(Unit: mm)

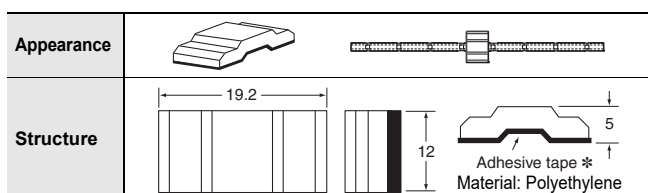

* The shape of the adhesive tape shown above is for securing the F03-16PE.

F03-16PT Fluoroplastic Sensing Band



- Compared to the F03-16PE (polyethylene), the F03-16PT has higher resistance to both high temperatures and chemicals.
- Detection precision remains constant even with a loopback, thanks to a two-sided detection design.

Ordering Information

Name	Model	
Fluoroplastic Sensing Band	1 m	F03-16PT 1M
	2 m	F03-16PT 2M
	5 m	F03-16PT 5M
	10 m	F03-16PT 10M
	15 m	F03-16PT 15M
	20 m	F03-16PT 20M
Fluoroplastic Sensing Band Stickers	F03-26PTN *	

Note: 1. Specify the cable length for F03-16PT from the list above.
2. The cables can be cut.

* 10 Stickers per set

Specifications

Sheath	PTFE fluoroplastic
Core	SUS316 stainless steel
Ambient operating temperature	-50 to 200°C
Weight	Approx. 16 g (1 m)

Dimensions Fluoroplastic Sensing Band F03-16PT

(Unit: mm)

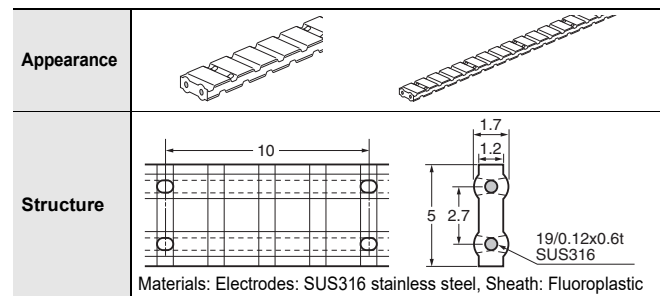

Fluoroplastic Sensing Band Stickers F03-26PTN (screws)

(Unit: mm)

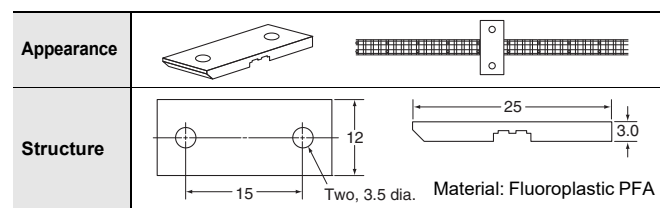

F03-15 Sensing Band



- Ideal for harsh electrical room environments that are dusty and humid.
- For installation in locations requiring insulated materials.

Ordering Information

Name	Model	
Liquid Leakage Sensing Band	1 m	F03-15 1M
	2 m	F03-15 2M
	5 m	F03-15 5M
	10 m	F03-15 10M
	15 m	F03-15 15M
	20 m	F03-15 20M
	25 m	F03-15 25M
	30 m	F03-15 30M
	40 m	F03-15 40M
	50 m	F03-15 50M
100 m	F03-15 100M	
Sensing Band Stickers	F03-25 *	

* 30 Stickers per bag

Specifications

Sheath	Flexible, transparent vinyl chloride
Core	SUS304 stainless steel
Ambient operating temperature	-15 to 50°C
Weight	Approx. 48 g (1 m)

Dimensions Sensing Band F03-15

(Unit: mm)

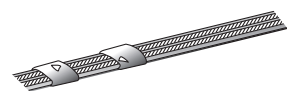
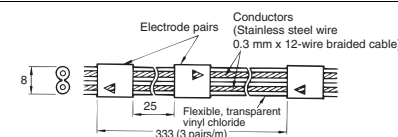
Appearance	
Structure	

Sensing Band Stickers F03-25

(Unit: mm)

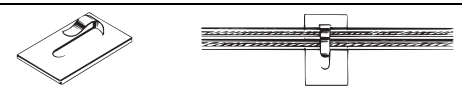
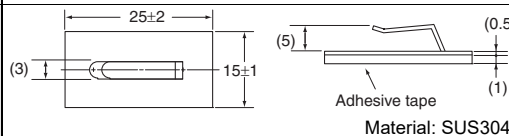
Appearance	
Structure	

F03-16PS Liquid Leakage Point Sensor



- Can be used in conjunction with Sensing Bands.
- Stud screw mounting requires no tools for installation.
- No tools means the Sensor can be wiped clean quickly and easily.
- The optional Mounting Bracket enables faster installation than three-screw mounting.
- Connect multiple Sensors to one K7L Amplifier for significant cost savings.

Ordering Information

Name	Model number
Liquid Leakage Point Sensor	F03-16PS
	F03-16PS-F *1
Mounting Brackets *2	F03-26PS
Terminal Block *3	F03-20

*1. The electrodes have a fluorine coating.

*2. Use a commercially available bonding agent for PVC. One bag contains 10 Brackets.

*3. One bag contains 10 Blocks.

Specifications

Material	Sensor Amplifier	Polyethylene
	Conductor	Outer sheath: PVC, Inner sheath: Fluorine resin
	Core	F03-16PS: SUS304 stainless steel F03-16PS-F: SUS304 and fluorine coating
Ambient operating temperature range	-10 to 60°C	
Weight	Approx. 30 g	
Maximum number of Point Sensors connected per Amplifier	You can use as many Point Sensors as required as long as the following conditions are met. K7L-AT50 (K7L-AT50D cannot be used): 60 m max. K7L-U (K7L-UD cannot be used): 400 m max. 61F-GPN-V50: 200 m max. 61F-WL-CPI-NRA: 200 m max.	

Note: Operation may not be possible with small amounts of liquid.

Wiring Diagram

Any number of Sensors can be connected in parallel as long as the following cable lengths are not exceeded for the Sensing Bands and connecting cables.

K7L-AT50 (operate resistance of 50 MW max.): 60 m max.

K7L-U (operate resistance of 1 MW max.): 400 m max.

However, the leakage areas cannot be determined with the K7L-AT50.

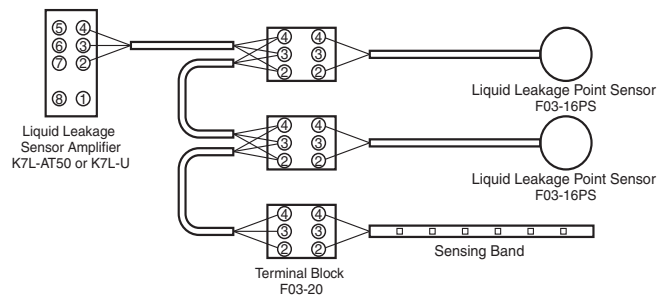

K7L-AT50 : Total length of 60 m max. (Sensing Bands: 10 m max.)
K7L-U : Total length of 400 m max.

Dimensions

Refer to pages 17 and 18.

Connecting the Sensing Band

Connecting F03-20 Terminal Blocks and Sensing Cables

The F03-20 Terminal Block is provided to connect the connecting cable from the K7L Liquid Leakage Sensor Amplifier to a Sensing Band in a liquid detection application.

Stripping and Connecting Terminals

1. Cut into the Sensing Band approximately 4 to 6 cm in from the end as shown in the diagram below.
2. Strip away approximately the last 9 mm of the sheath to expose the core (SUS line).
3. To connect to the Terminal Block, insert the screwdriver * from the top of the Terminal Block and insert the stripped end of the core from the side. (Refer to *Dimensions* on page 17.)

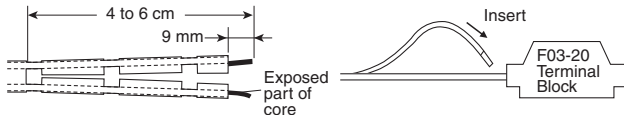

Note: Check that the wiring is secure before using the K7L in applications.

* You can use a commercially available screwdriver, but we recommend either 1) a 210-350/01 Screwdriver or 2) a 209-132 Operating Tool from Wago. Information: //www.wago.com

The F03-20 Terminal Block was designed to maintain continuity between the connecting cable and Sensing Band. The tensile strength after connection to the Sensing Band was not considered. If the Sensing Band may be pulled, use F03-26PES Sensing Band Stickers to secure it. If it is located where people may step on it, attach a commercially available cover to take other measures to ensure that the Sensing Band connected to a Terminal Block is not subjected to external force.

Application Examples in Which an F03-16PE Sensing Band Is More Difficult to Pull Free from an F03-20 Terminal Block

- Fold the electrode section of the Sensing Band to double the electrode plate thickness and insert it into the Terminal Block.
- Attach round crimp terminals on the electrode section of the Sensing Band and connect them to a commercially available terminal block.

If required by your application, another method can be used (e.g., installation with suitable connectors).

After installation, confirm that a reliable electrical connection has been achieved.

Also, when you remove a Sensing Band from an F03-20 Terminal Block, do not pull it with excessive force. Remove it while inserting a screwdriver from the top of the Terminal Block.

Interval Between Stickers

When securing the Sensing Band with Stickers, attach the Stickers at intervals of 20 to 30 cm in places where the core is not exposed.

Secure the Sensing Band as close to a Terminal Block or Terminator as possible.

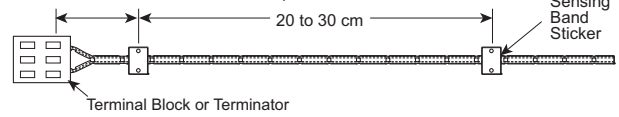

- Note:**
1. When using the F03-26PES (adhesive-tape model), be sure to wipe all moisture, oil, and dust from the surface to which the Sticker is to be attached. Failure to do so may result in insufficient adhesion, and the Sticker may peel away from the surface.
 2. When using the F03-26PEN (screw model), before installing the Sensing Band, it is necessary to perform stud welding. For details on the pitch of the studs, refer to the information on the dimensions of Sensing Band Stickers.
 3. If you connect a Sensor Band with an F03-20 Terminal Block and F03-20T Terminator, secure the Sensing Band with Sensing Stickers near the Terminal Block and Terminator to help adsorb stress, e.g., from something pulling on the Sensing Band.

Bending the Sensing Band

To change the direction of the Sensing Band, bend the Sensing Band in one or two places where the core is not exposed.

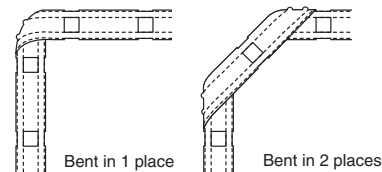

Note: Bend the Sensing Band approximately 4 cm (i.e., twice the distance between places where a Sticker is attached) away from places where a Sticker is attached. If the Sensing Band is bent at places further away than this, the Sensing Band may come away from the surface.

Chemical Resistivity (F03-16PE, F03-16PT)

	Polyethylene	SUS316	Fluoro plastic
Water	A	A	A
Acetone	C	A	A
Ammonia	A	A	A
Ethanol	B	A	A
Hydrochloric acid	A	C	A
Hydrogen peroxide solution	A	A	A
Xylene	B	A	A
Cyclohexane	C	---	A
Trichloroethylene	C	A	A

	Polyethylene	SUS316	Fluoro plastic
Toluene	C	B	B
Phenol	B	A	B
Butanol	B	---	A
Fluorine	A	C	A
Hexane	C	---	A
Benzene	C	A	A
Methanol	B	A	A
Sulfuric acid	C	B	A
Phosphoric acid	A	B	B

- Note:**
1. The F03-16PE Sensing Band is made from the following materials.
Core: SUS316
Insulated sheath: Polyethylene
 2. In order to prevent secondary fire damage, consider the effect of the atmosphere of the environment and the solution to be detected on the Sensing Band.
 3. If the Sensing Band changes shape or color when a liquid is detected, replace the Sensing Band.

A: Not affected at all or only very slightly affected.
C: Affected but may still be used. (Replace the Sensing Band immediately after detection.)

B: Slightly affected but, depending on the conditions, sufficient for use.

F03-16SF/-16SFC

Liquid Leakage Sensing Band

F03-16SF/F03-16SFC

Liquid Leakage Sensing Band

Greater flexibility and superior workability compared with the F03-16PE. The sheath becomes transparent to reveal the red inner sheath if liquid leakage occurs, thereby enabling visual confirmation. After drying, the Sensing Band color will return to white.

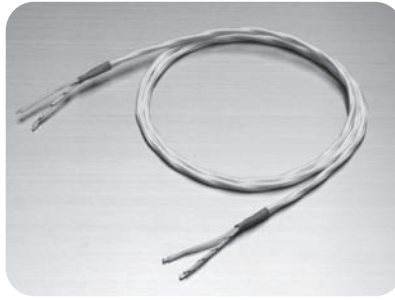

F03-16SF

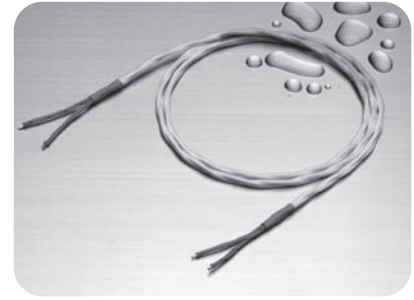

F03-16SFC (with color indication)

Ordering Information

Length	Type	Liquid Leakage Sensing Band (without color indication) F03-16SF	Liquid Leakage Sensing Band (with color indication) F03-16SFC
		Model	Model
5 m		F03-16SF-5M	F03-16SFC-5M
10 m		F03-16SF-10M	F03-16SFC-10M
20 m		F03-16SF-20M	F03-16SFC-20M
30 m		F03-16SF-30M	F03-16SFC-30M
50 m		F03-16SF-50M	F03-16SFC-50M
100 m		F03-16SF-100M	F03-16SFC-100M

Note: When you select a Sensing Band, confirm the suitability for the detection liquid and the specifications of the Water/Liquid Leakage Sensor.

Specifications

Sheath	Special plastic fiber braided cable with water-absorbent and water-repellent characteristics
Core	Tin-plated, copper-stranded wire 0.75mm ²
Ambient operating temperature	-15 to 60°C
Weight	Approximately 20 g (1 m)

Note: 1. In order to prevent secondary fire damage, consider the effect of the atmosphere of the environment and the solution to be detected on the Sensing Band.

2. If the Sensing Band becomes misshapen, discolored, or otherwise abnormal after detection, replace the Sensing Band.

Dimensions Sensing Band

(Unit: mm)

Item	Type	Liquid Leakage Sensing Band F03-16SF	Liquid Leakage Sensing Band (with color indication) F03-16SFC
Appearance			
Structure			

Cable Sticker

Appearance	
Dimensions	

Adhesive tape *
Material: SUS304

Terms and Conditions Agreement

Read and understand this catalog.

Please read and understand this catalog before purchasing the products. Please consult your OMRON representative if you have any questions or comments.

Warranties.

- (a) Exclusive Warranty. Omron's exclusive warranty is that the Products will be free from defects in materials and workmanship for a period of twelve months from the date of sale by Omron (or such other period expressed in writing by Omron). Omron disclaims all other warranties, express or implied.
- (b) Limitations. OMRON MAKES NO WARRANTY OR REPRESENTATION, EXPRESS OR IMPLIED, ABOUT NON-INFRINGEMENT, MERCHANTABILITY OR FITNESS FOR A PARTICULAR PURPOSE OF THE PRODUCTS. BUYER ACKNOWLEDGES THAT IT ALONE HAS DETERMINED THAT THE PRODUCTS WILL SUITABLY MEET THE REQUIREMENTS OF THEIR INTENDED USE.

Omron further disclaims all warranties and responsibility of any type for claims or expenses based on infringement by the Products or otherwise of any intellectual property right. (c) Buyer Remedy. Omron's sole obligation hereunder shall be, at Omron's election, to (i) replace (in the form originally shipped with Buyer responsible for labor charges for removal or replacement thereof) the non-complying Product, (ii) repair the non-complying Product, or (iii) repay or credit Buyer an amount equal to the purchase price of the non-complying Product; provided that in no event shall Omron be responsible for warranty, repair, indemnity or any other claims or expenses regarding the Products unless Omron's analysis confirms that the Products were properly handled, stored, installed and maintained and not subject to contamination, abuse, misuse or inappropriate modification. Return of any Products by Buyer must be approved in writing by Omron before shipment. Omron Companies shall not be liable for the suitability or unsuitability or the results from the use of Products in combination with any electrical or electronic components, circuits, system assemblies or any other materials or substances or environments. Any advice, recommendations or information given orally or in writing, are not to be construed as an amendment or addition to the above warranty.

See <http://www.omron.com/global/> or contact your Omron representative for published information.

Limitation on Liability; Etc.

OMRON COMPANIES SHALL NOT BE LIABLE FOR SPECIAL, INDIRECT, INCIDENTAL, OR CONSEQUENTIAL DAMAGES, LOSS OF PROFITS OR PRODUCTION OR COMMERCIAL LOSS IN ANY WAY CONNECTED WITH THE PRODUCTS, WHETHER SUCH CLAIM IS BASED IN CONTRACT, WARRANTY, NEGLIGENCE OR STRICT LIABILITY.

Further, in no event shall liability of Omron Companies exceed the individual price of the Product on which liability is asserted.

Suitability of Use.

Omron Companies shall not be responsible for conformity with any standards, codes or regulations which apply to the combination of the Product in the Buyer's application or use of the Product. At Buyer's request, Omron will provide applicable third party certification documents identifying ratings and limitations of use which apply to the Product. This information by itself is not sufficient for a complete determination of the suitability of the Product in combination with the end product, machine, system, or other application or use. Buyer shall be solely responsible for determining appropriateness of the particular Product with respect to Buyer's application, product or system. Buyer shall take application responsibility in all cases.

NEVER USE THE PRODUCT FOR AN APPLICATION INVOLVING SERIOUS RISK TO LIFE OR PROPERTY OR IN LARGE QUANTITIES WITHOUT ENSURING THAT THE SYSTEM AS A WHOLE HAS BEEN DESIGNED TO ADDRESS THE RISKS, AND THAT THE OMRON PRODUCT(S) IS PROPERLY RATED AND INSTALLED FOR THE INTENDED USE WITHIN THE OVERALL EQUIPMENT OR SYSTEM.

Programmable Products.

Omron Companies shall not be responsible for the user's programming of a programmable Product, or any consequence thereof.

Performance Data.

Data presented in Omron Company websites, catalogs and other materials is provided as a guide for the user in determining suitability and does not constitute a warranty. It may represent the result of Omron's test conditions, and the user must correlate it to actual application requirements. Actual performance is subject to the Omron's Warranty and Limitations of Liability.

Change in Specifications.

Product specifications and accessories may be changed at any time based on improvements and other reasons. It is our practice to change part numbers when published ratings or features are changed, or when significant construction changes are made. However, some specifications of the Product may be changed without any notice. When in doubt, special part numbers may be assigned to fix or establish key specifications for your application. Please consult with your Omron's representative at any time to confirm actual specifications of purchased Product.

Errors and Omissions.

Information presented by Omron Companies has been checked and is believed to be accurate; however, no responsibility is assumed for clerical, typographical or proofreading errors or omissions.

Note: Do not use this document to operate the Unit.

OMRON Corporation Industrial Automation Company

Kyoto, JAPAN

Contact : www.ia.omron.com

Regional Headquarters

OMRON EUROPE B.V.

Wegalaan 67-69, 2132 JD Hoofddorp
The Netherlands
Tel: (31) 2356-81-300 Fax: (31) 2356-81-388

OMRON ELECTRONICS LLC

2895 Greenspoint Parkway, Suite 200
Hoffman Estates, IL 60169 U.S.A.
Tel: (1) 847-843-7900 Fax: (1) 847-843-7787

OMRON ASIA PACIFIC PTE. LTD.

438B Alexandra Road, #08-01/02 Alexandra
Technopark, Singapore 119968
Tel: (65) 6835-3011 Fax: (65) 6835-3011

OMRON (CHINA) CO., LTD.

Room 2211, Bank of China Tower,
200 Yin Cheng Zhong Road,
PuDong New Area, Shanghai, 200120, China
Tel: (86) 21-6023-0333 Fax: (86) 21-5037-2388

Authorized Distributor:

©OMRON Corporation 2016-2024 All Rights Reserved.
In the interest of product improvement,
specifications are subject to change without notice.

CSM_6_5

Cat. No. N211-E1-13 0324 (0316)