

# New standards for proximity sensors Fewer collisions, easier replacement and design, and greater flexibility

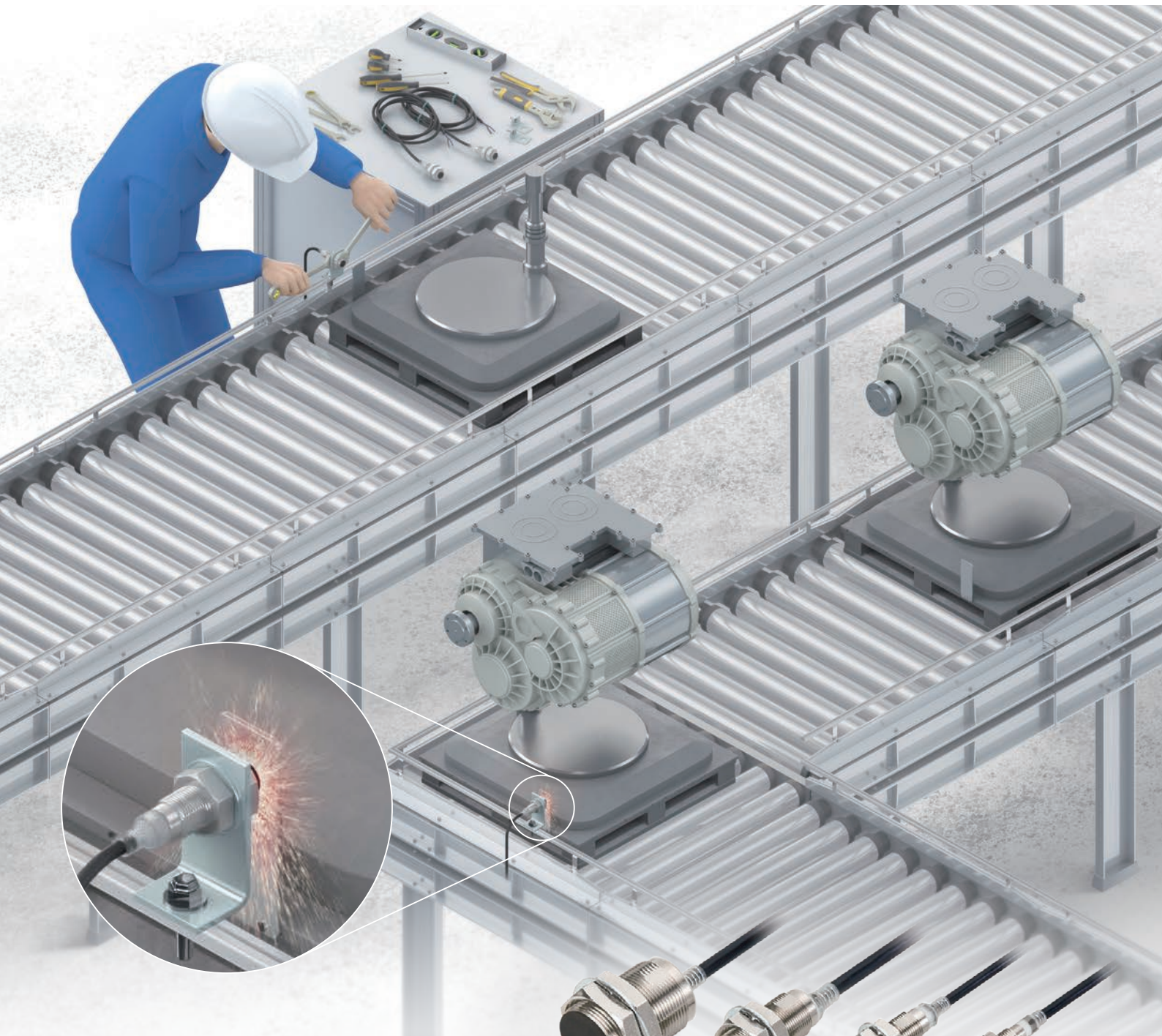

# E2E NEXT Series brings great flexibility to manufacturing sites

Proximity sensors are often used in harsh environments. Due to their short sensing distances, they tend to be damaged by collisions and require frequent replacements. When a proximity sensor is installed in the innermost corner of equipment, the poor visibility of the indicator makes operation difficult. Also it takes time to select appropriate sensors for design requirements. With our long experience in manufacturing, we provide effective solutions from design and commissioning through to operation and maintenance, contributing to streamlining operations and improving productivity at manufacturing sites.

Exceptional sensing range \*1



\*1. Based on Omron investigation in August 2022. \*2. DC 2-wire, M12 shielded model.

Note: 1. The image shows the actual size of the proximity sensors and sensing distances.

Note: 2. DC 2-wire, M8 and M12 triple distance models include two toothed washers.

## Minimize replacement frequency of damaged sensors



Long-distance detection ensures stable operation and reduces unexpected maintenance ..... P.4

## Reduce adjustment time during installation



Installation requires no special skills, shortening setup and recovery time ..... P.6

## Standardize on a single series for most applications

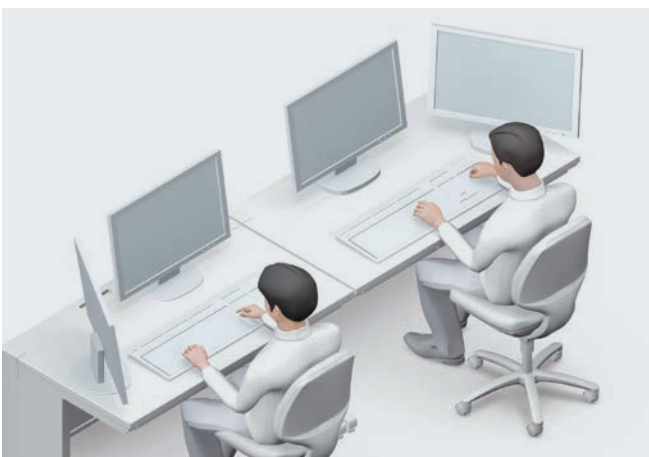

A wide range of applications facilitate equipment design ..... P.8

# Long-distance detection ensures stable operation and reduces unexpected maintenance

## Free from malfunctions and collisions

Quadruple/triple distance model

### Reduces false detection due to a stationary moved by machine vibration

Vibration associated with machines or heavy load pallets can cause malfunction of proximity sensors, which results in the equipment stoppage. E2E NEXT triple distance models reduce such malfunctions, increasing equipment uptime.

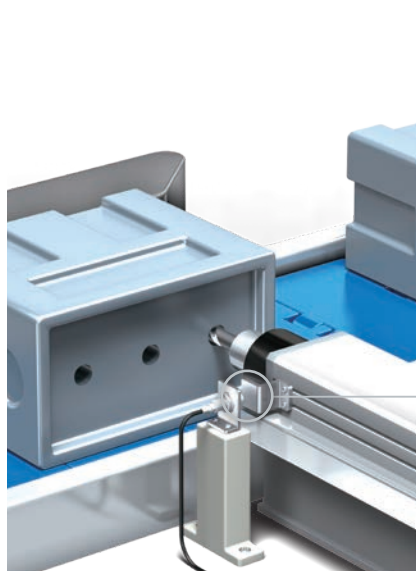

Spindle presence detection

#### Previous models

Machine vibration widens the distance between the stationary and proximity sensor to cause false detection and equipment stoppage.

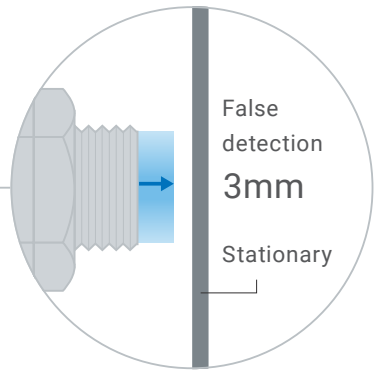

#### E2E NEXT

Long-distance detection gives great flexibility in terms of sensing distance, enabling stable detection even when the stationary gets away.

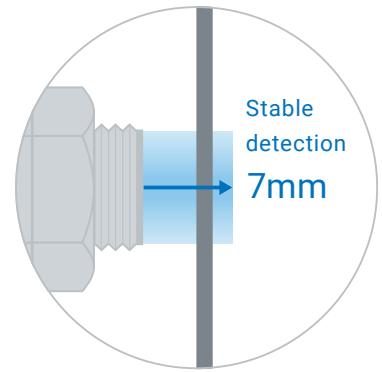

Note: The sensing distance is for the DC 2-wire, M12 triple distance model.

### Reduces collisions caused by variation in workpiece sitting position

Proximity sensors sometimes collide with workpieces during sitting position detection, causing sensor failure. E2E NEXT triple distance models reduce these collisions and improve equipment uptime.



Sitting position check of metal plates to weld

#### Previous models

A workpiece moves closer to the sensor to cause failure and damage due to collision, and the equipment stops.

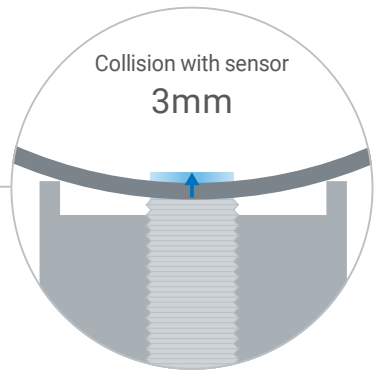

#### E2E NEXT

Long-distance detection allows enough space from a workpiece, reducing collision risks.

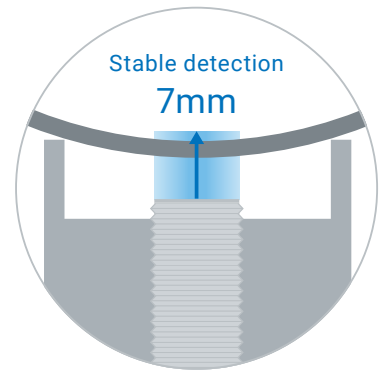

Note: The sensing distance is for the DC 2-wire, M12 triple distance model.

# Double the sensing distance of standard models

## Quadruple/triple distance model

### Sensing distance comparison

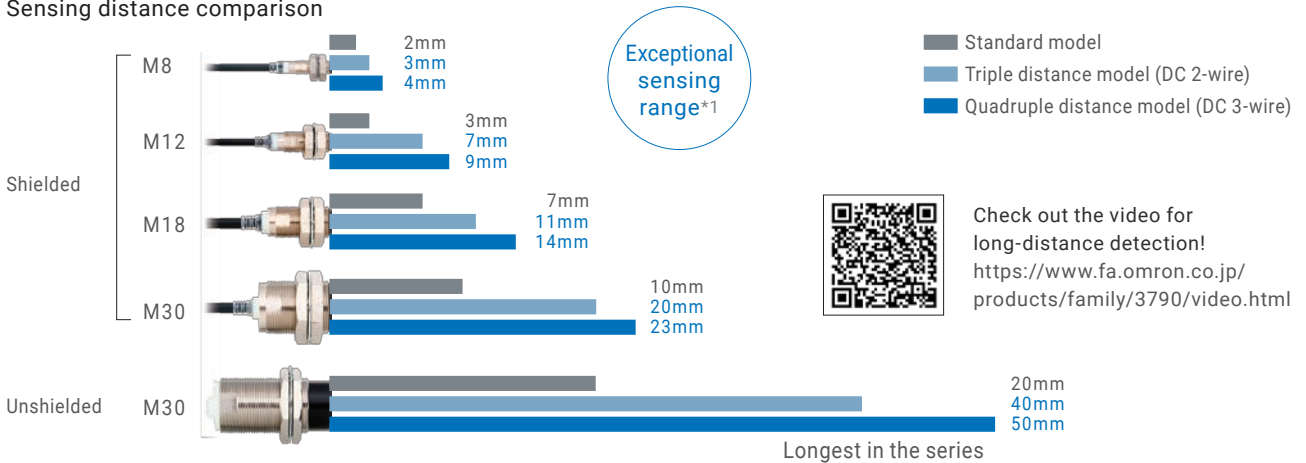

Check out the video for long-distance detection!  
<https://www.fa.omron.co.jp/products/family/3790/video.html>

### Improvement example

## The E2E NEXT Series reduces equipment downtime caused by proximity sensors to 1/3

The annual total of unexpected equipment downtime at an automotive parts manufacturing site was around 1,600 hours, of which 240 hours were caused by proximity sensors.  
 The use of E2E NEXT triple distance models reduced the number of equipment stoppages due to collisions and malfunctions from 240 to 80, shortening equipment downtime to 1/3.  
 (Based on Omron investigation in September 2017.)

Equipment downtime
Previous models
<b>240</b> hours per year
Number of proximity sensor failures: 240/year × recovery time: about 60 min/sensor*2
E2E NEXT
<b>80</b> hours per year
Long sensing distance reduces failures caused by collisions and malfunctions.
Number of proximity sensor failures: 80/year × recovery time: about 60 min/sensor*2

\*1. Based on Omron investigation in August 2022. \*2. Time required from locating failure to replacing a sensor and recovering.

## Thermal Distance Control technology for stable long-distance detection × IoT

With the Thermal Distance Control technology for stable long-distance detection and the analog digital hybrid IC, the E2E NEXT Series eliminates the influence of temperature changes and variation between different sensors, which were difficulties in increasing the sensing distance.

### DC 2-wire, triple distance model (Thermal Distance Control)

Temperature correction values are written into the analog digital hybrid IC (PROX2) for the factory setting, which was not possible for previous analog ICs, to minimize the influence of temperature changes on sensing distance.

### DC 3-wire, quadruple distance model **Patented**\*3

Temperature characteristics of each sensor are measured in an IoT-enabled production process, and then optimal correction values are calculated based on our unique algorithm and written to the analog digital hybrid IC (PROX3). This minimizes the influence of temperature change on sensing distance and variation between different sensors.

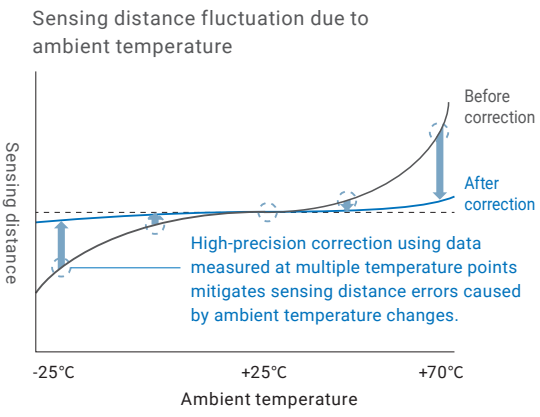

\*3. "Patent Pending" means that we applied for a patent in Japan, and "Patented" means that we obtained a patent in Japan. (As of September 2022)

# Installation requires no special skills, shortening setup and recovery time

## No adjustment of indicator orientation required

All models

### 360° visible indicator for ease of work

The indicator can be seen regardless of the mounting orientation of the proximity sensor, making it easy to check the detection status.

Previous models

The indicator is invisible depending on the orientation of the installed sensor. When the sensor is installed in the innermost corner of equipment, the detection status cannot be checked.

E2E NEXT

The high-brightness LED indicator is visible from 360°, allowing easy confirmation of the detection status.



The 360° visible indicator reduces adjustment time.

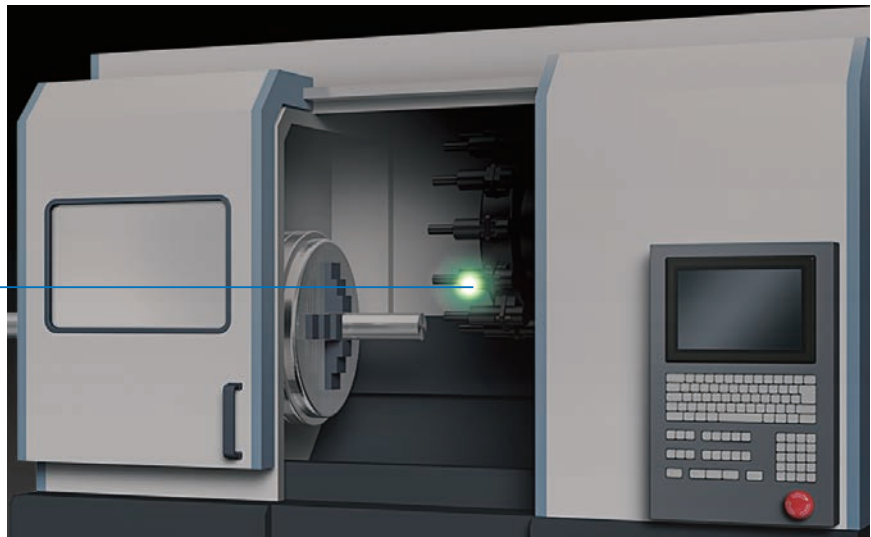

Note: The image is of the 2-wire model.

## Indicator for ease of checking operating status

All E2E NEXT Proximity Sensors come equipped with green and orange LED indicators.

### DC 2-wire model

The green indicator is ON in the stable sensing area, and the orange indicator is ON in the unstable sensing area.



### Rated sensing distance

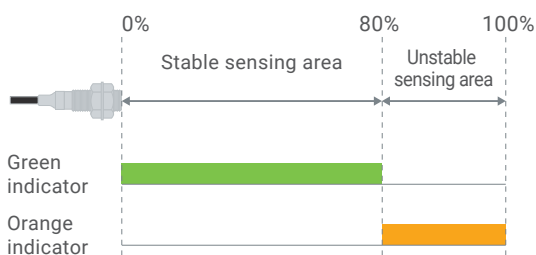

### DC 3-wire model

The orange indicator is ON both in the stable and unstable sensing areas, and the green indicator flashes during IO-Link communications.



### Rated sensing distance

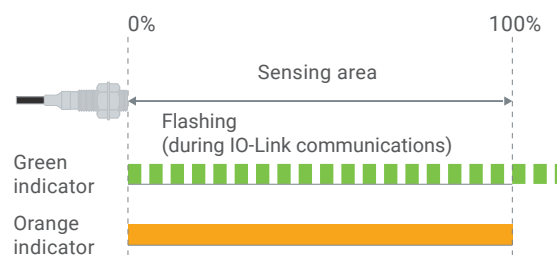

# No distance adjustment required during replacement

Quadruple/triple distance model

## Simple 10-second\*1 replacement using e-jig

Virtually anyone can easily fix the proximity sensor in the same position, greatly reducing replacement time.

**Previous models**

A lot of time is required to optimize the distance.  
The adjustment position varies depending on skills, making detection unstable.

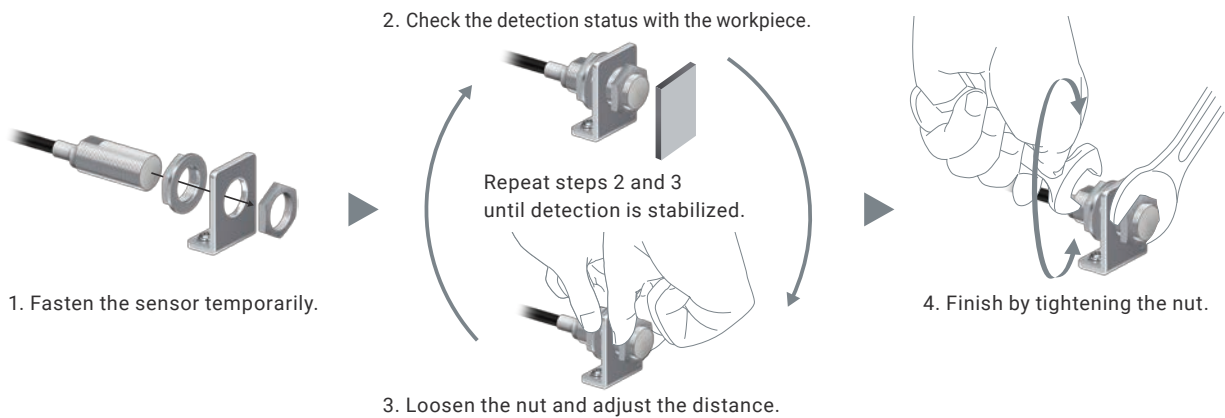

**E2E NEXT**

Replacement time is reduced significantly to approximately **10 seconds**\*1.  
Anyone can mount the sensor in the same position without adjustment.

1. Insert the sensor into an e-jig.

2. Just fix the sensor.

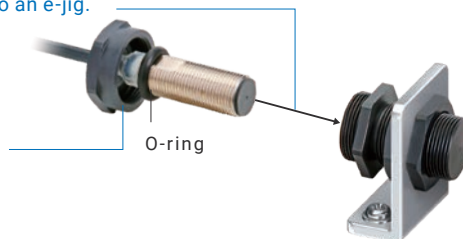

**Patented** \*2

The O-ring blocks the ingress of foreign matter, including cutting oil, into the e-jig and ensures positioning precision (IP67G).

\*1. Time required to adjust the distance during sensor installation. Based on Omron investigation.

\*2. "Patent Pending" means that we applied for a patent in Japan, and "Patented" means that we obtained a patent in Japan. (As of September 2022)

## Easy upgrade to equipment with sensors that are "replaceable in 10 seconds"

The sensing distance of E2E NEXT triple distance models is nearly double that of previous models. For example, the sensing distance of M12 models is 7 mm, which is the same as conventional M18 models. Using the E2E NEXT Proximity Sensor together with the e-jig allows you to easily upgrade your existing equipment so that you can replace the sensor in just 10 seconds.

1. Dismount the M18 proximity sensor from the existing equipment.

2. Mount an M18-sized e-jig.

3. Insert an E2E NEXT M12 triple distance model into the e-jig.

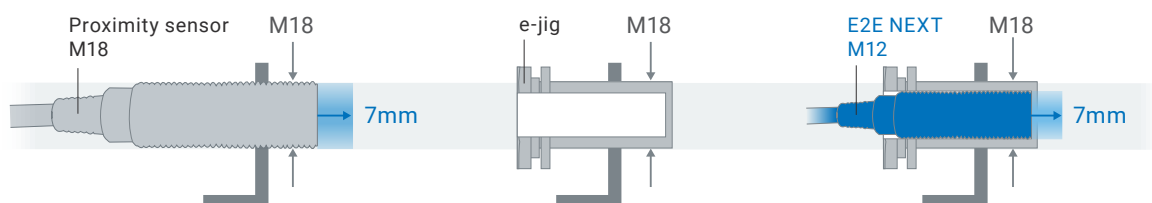

Note: The sensing distance is for the DC 2-wire, M12 triple distance model.

# A wide range of applications facilitate equipment design

## Downsize equipment

### Smaller sensors for same sensing distance

Quadruple/triple distance model

The increased sensing distance allows you to use one size smaller sensors without reducing sensing distance, which helps save installation space.

**Previous models** Proximity sensors are installed apart from each other to avoid mutual interference.

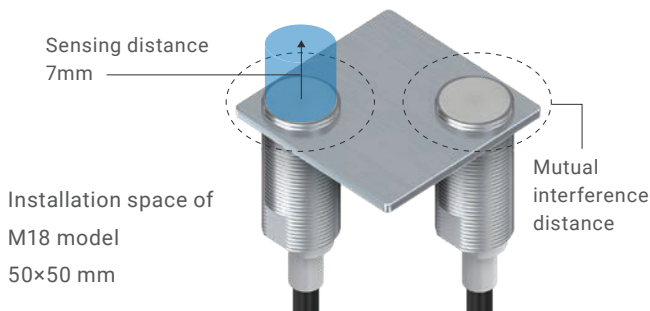

**E2E NEXT** Smaller proximity sensors can be installed closer to each other thanks to their shorter mutual interference distance.

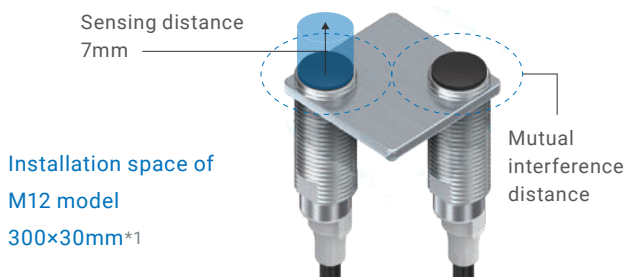

\*1. Quadruple and triple distance models.  
Note: The sensing distance is for the DC 2-wire, M12 triple distance model.

## Bring IoT to equipment

### Predictive maintenance by detecting changes in equipment using IO-Link

3-wire model

By connecting IO-Link proximity sensors to the IO-Link master, you can monitor the equipment status in real time, leading to predictive maintenance.

**When workpiece is too close to sensor**  
IO-Link allows the sensor to output measured values for monitoring in order to detect that a workpiece is too close to the sensor and avoid collision.

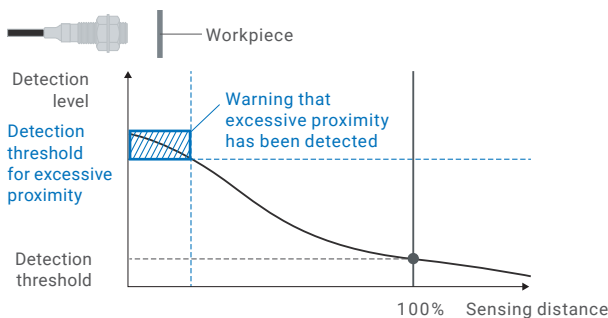

**When workpiece is too far from sensor**  
IO-Link allows the sensor to output measured values for monitoring in order to detect that a workpiece is too far from the sensor and prevent false detection.

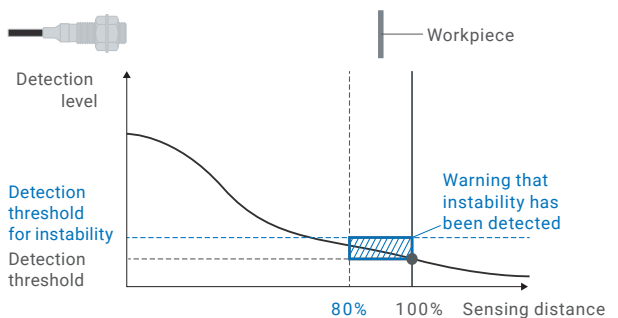

### Detection of proximity sensor failure with 2-output models

3-wire model

Failure can be detected by wiring two outputs, NO (Normally Open) and NC (Normally Closed), without using IO-Link.

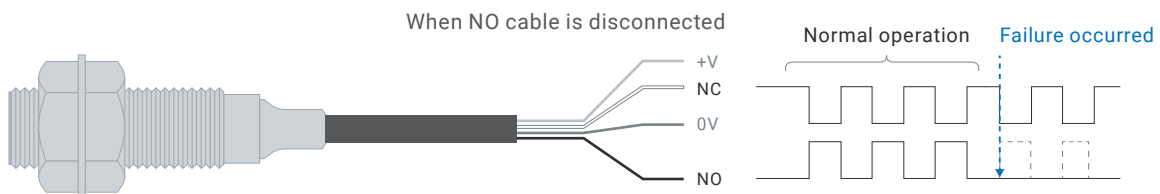



# Improve environmental resistance of machines

## Proven 2-year oil resistance\*2 brought by cable with enhanced oil resistance

All models

Unexpected failures caused by cutting oil, which account for approximately 30%\*3 of unexpected component failures, can be reduced.

### Previous models

The cable is damaged by cutting oil.



The PUR cable was cracked in environments where water-soluble cutting oil is used.

#### IP67G

Oil type	N3 (water-insoluble cutting oil)
Evaluation time	48 hours
Evaluation temperature	Room temperature
Dilution concentration	—
Criteria	Appearance and performance



### E2E NEXT

Tests to IP67G and our oil-resistant component evaluation standards have proven that the E2E NEXT Series withstands oil for two years\*2.



The E2E NEXT Proximity Sensors using a PVC cable with enhanced oil resistance have been evaluated according to IP67G (JIS C 0920) and our own, even stricter evaluation standards for oil-resistant components.

#### Omron's oil-resistant component evaluation standards

Oil type	A1 (water-soluble cutting oil)
Evaluation time	1,000 hours of machining
Evaluation temperature	55°C
Dilution concentration	Undiluted
Criteria	Appearance, performance, and no label text loss



Eight representative types of tested cutting oil

Test oil type	JIS classification	Oil
Water-soluble cutting oil	A1	Yushiroken EC50T-3 YushirokenFGE366 YushirokenFX90
	A2	YushirokenFGM427 YushirokenFGS700
	A3	YushirokenFGC950PR
Water-insoluble cutting oil	N3	Yushiron Cut Abas BZ224K
	N4	Yushiron Cut Abas KZ440

## Pre-wired connector models have also been proven to provide stable operation for 2 years\*2 by same tests

Pre-wired connector models, which use a highly oil-resistant PVC cable and our unique technology, have been proven to withstand oil for two years\*2.

Patented\*4

The Smartclick connector allows anyone to tighten cables with the same torque and blocks the ingress of cutting oil.

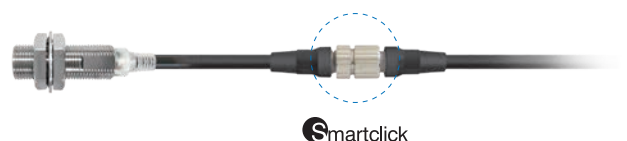





Note: Smartclick is a registered trademark of OMRON Corporation.





\*2. Tested on cutting oil specified in JIS K 2241:2000 ("2-year oil resistance" refers to median values (=Typical values) of the product designs and the oil-resistance performance evaluation results. Products to be shipped will have around 2 years of oil resistance; actual oil resistance will vary depending on the product.)The pre-wired connector model has been proven to offer 2 years of oil resistance when mated with the XS5 NEXT Round Oil-resistant Connector. 3-wire connector models (M1, M3, M5) have not been tested.

\*3. Based on Omron investigation in June 2016.

\*4. "Patent Pending" means that we applied for a patent in Japan, and "Patented" means that we obtained a patent in Japan. (As of September 2022)

## E2E NEXT Series Functions and Specifications

Main functions and specifications			DC 2-wire						
			Shielded				Unshielded		
									
			Triple distance	Double distance	Standard	Single distance	Triple distance	Double distance	Standard
Detection performance	Sensing distance	M8	3mm	—	2mm	1.5mm	6mm	—	4mm
		M12	7mm	4mm	3mm	2.5mm	10mm	—	8mm
		M18	11mm	8mm	7mm	5mm	20mm	16mm	14mm
		M30	20mm	15mm	10mm	—	40mm	30mm	20mm
Installation	Flush with surface	—	—	●	●	—	—	—	
	Flush with surface using nut	● *1	●	●	●	—	—	—	
Usability	360° visible indicator		●	●	●	●	●	●	●
	e-jig		● *3	—	—	—	—	—	—
Industrial IoT enabled	Detection level and temp. visualization with IO-Link		—	—	—	—	—	—	—
	2-output model		—	—	—	—	—	—	—
Environmental resistance	Oil resistance	2 years	●	●	●	●	●	●	●
Datasheet			P.14 ~	P.25 ~	P.24 ~	P.25 ~	P.14 ~	P.25 ~	P.24 ~

DC 3-wire							
Shielded				Unshielded			
							
Quadruple distance	Triple distance	Double distance	Single distance	Quadruple distance	Triple distance	Double distance	Single distance
4mm	3mm	2mm	1.5mm	8mm	6mm	4mm	2mm
9mm	6mm	4mm	2mm	16mm	10mm	8mm	5mm
14mm	12mm	8mm	5mm	30mm	20mm	16mm	10mm
23mm	22mm	15mm	10mm	50mm	40mm	30mm	18mm
—	—	● *2	●	—	—	—	—
—	● *1	●	●	—	—	—	—
●	●	●	●	●	●	●	●
● *3	● *3	—	—	—	—	—	—
●	●	●	●	●	●	●	●
—	●	●	●	—	●	●	●
●	●	●	●	●	●	●	●
P.40 ~	P.43 ~	P.47 ~	P.51 ~	P.42 ~	P.45 ~	P.49 ~	P.53 ~

\*1. The nuts are longer than other models. Please refer to the datasheet for details.

\*2. Applicable to some models. Please refer to datasheet for details.

\*3. Pre-wired models only.



## Long-distance Detection Prevents Unexpected Facility Stoppages

- The world's longest sensing distance\*<sup>1</sup>  
Nearly double the sensing distance of previous
- With high-brightness LED, the indicator is visible anywhere from 360°.
- Only 10 Seconds\*<sup>2</sup> to Replace a Proximity Sensor with the "e-jig" (Mounting Sleeve).
- Cables with enhanced oil resistance enabled 2-year oil resistance\*<sup>3</sup>.
- IP69K compliant for water resistance and wash resistance.
- UL certification (UL60947-5-2) and CSA certification (CSA C22.2 UL60947-5-2-14)

\*1. Based on August 2022 OMRON investigation.  
\*2. Time required to adjust the distance when installing a Sensor. Based on OMRON investigation.  
\*3. Refer to page 16 for details.

 Be sure to read *Safety Precautions* on page 19.



For the most recent information on models that have been certified for safety standards, refer to your OMRON website.

## Model Number Legend

E2E - X (1) (2) D (3) (4) (5) - (6) - (7) (8) (9)

No.	Classification	Code	Meaning
(1)	Sensing distance	Number	Sensing distance (Unit: mm) (R: Indication of decimal point)
(2)	Shielding	Blank	Shielded Models
		M	Unshielded Models
(3)	Operation mode	1	Normally open (NO)
		2	Normally closed (NC)
(4)	Body size	Blank	Standard
		L	Long Body
(5)	Size	8	M8
		12	M12
		18	M18
		30	M30
(6)	Connecting method	Blank	Pre-wired Models
		M1TGJ	M12 Pre-wired Smartclick Connector Models
		M1TGJR	M12 Pre-wired Smartclick Connector Models (Robot (bending-resistant) PVC cable)
(7)	Polarity	Blank	Polarity
		T	No polarity
(8)	Cable specifications (Only shown in the model number of Pre-wired Models.)	Blank	Standard PVC cable
		R	Robot (bending-resistant) PVC cable
(9)	Cable length	Number M	Cable length

**Note:** 1. The purpose of this model number legend is to provide understanding of the meaning of specifications from the model number.  
2. Pin arrangements vary depending on the model. Refer to I/O Circuit Diagrams on page 18 for details.

# E2E NEXT Series

## Ordering Information

### Sensors

DC 2-wire (Triple distance model) [Refer to *Dimensions* on page 21.]

#### Shielded Models \*1

Size (Sensing distance)	Connection method	Polarity	Model	
			Operation mode: NO	Operation mode: NC
M8 (3 mm)	Pre-wired (2 m) *2 *3	Yes	E2E-X3D18 2M	E2E-X3D28 2M
		No	E2E-X3D18-T 2M	E2E-X3D28-T 2M
	M12 Pre-wired Smartclick Connector (0.3 m) *4	Yes	E2E-X3D18-M1TGJ 0.3M	E2E-X3D28-M1TGJ 0.3M
		No	E2E-X3D18-M1TGJ-T 0.3M	E2E-X3D28-M1TGJ-T 0.3M
M12 (7 mm)	Pre-wired (2 m) *2 *3	Yes	E2E-X7D112 2M	E2E-X7D212 2M
		No	E2E-X7D112-T 2M	E2E-X7D212-T 2M
	M12 Pre-wired Smartclick Connector (0.3 m) *4	Yes	E2E-X7D112-M1TGJ 0.3M	E2E-X7D212-M1TGJ 0.3M
		No	E2E-X7D112-M1TGJ-T 0.3M	E2E-X7D212-M1TGJ-T 0.3M
M18 (11 mm)	Pre-wired (2 m) *2 *3	Yes	E2E-X11D118 2M	E2E-X11D218 2M
		No	E2E-X11D118-T 2M	E2E-X11D218-T 2M
	M12 Pre-wired Smartclick Connector (0.3 m) *4	Yes	E2E-X11D118-M1TGJ 0.3M	E2E-X11D218-M1TGJ 0.3M
		No	E2E-X11D118-M1TGJ-T 0.3M	E2E-X11D218-M1TGJ-T 0.3M
M30 (20 mm)	Pre-wired (2 m) *2 *3	Yes	E2E-X20D130 2M	E2E-X20D230 2M
		No	E2E-X20D130-T 2M	E2E-X20D230-T 2M
	M12 Pre-wired Smartclick Connector (0.3 m) *4	Yes	E2E-X20D130-M1TGJ 0.3M	E2E-X20D230-M1TGJ 0.3M
		No	E2E-X20D130-M1TGJ-T 0.3M	E2E-X20D230-M1TGJ-T 0.3M

#### Unshielded Models

Size (Sensing distance)	Connection method	Polarity	Model	
			Operation mode: NO	Operation mode: NC
M8 (6 mm)	Pre-wired (2 m) *2 *3	Yes	E2E-X6MD18 2M	E2E-X6MD28 2M
		No	E2E-X6MD18-T 2M	E2E-X6MD28-T 2M
	M12 Pre-wired Smartclick Connector (0.3 m) *4	Yes	E2E-X6MD18-M1TGJ 0.3M	E2E-X6MD28-M1TGJ 0.3M
		No	E2E-X6MD18-M1TGJ-T 0.3M	E2E-X6MD28-M1TGJ-T 0.3M
M12 (10 mm)	Pre-wired (2 m) *2 *3	Yes	E2E-X10MD112 2M	E2E-X10MD212 2M
		No	E2E-X10MD112-T 2M	E2E-X10MD212-T 2M
	M12 Pre-wired Smartclick Connector (0.3 m) *4	Yes	E2E-X10MD112-M1TGJ 0.3M	E2E-X10MD212-M1TGJ 0.3M
		No	E2E-X10MD112-M1TGJ-T 0.3M	E2E-X10MD212-M1TGJ-T 0.3M
M18 (20 mm)	Pre-wired (2 m) *2 *3	Yes	E2E-X20MD1L18 2M	E2E-X20MD2L18 2M
		No	E2E-X20MD1L18-T 2M	E2E-X20MD2L18-T 2M
	M12 Pre-wired Smartclick Connector (0.3 m) *4	Yes	E2E-X20MD1L18-M1TGJ 0.3M	E2E-X20MD2L18-M1TGJ 0.3M
		No	E2E-X20MD1L18-M1TGJ-T 0.3M	E2E-X20MD2L18-M1TGJ-T 0.3M
M30 (40 mm)	Pre-wired (2 m) *2 *3	Yes	E2E-X40MD1L30 2M	E2E-X40MD2L30 2M
		No	E2E-X40MD1L30-T 2M	E2E-X40MD2L30-T 2M
	M12 Pre-wired Smartclick Connector (0.3 m) *4	Yes	E2E-X40MD1L30-M1TGJ 0.3M	E2E-X40MD2L30-M1TGJ 0.3M
		No	E2E-X40MD1L30-M1TGJ-T 0.3M	E2E-X40MD2L30-M1TGJ-T 0.3M

\*1. When embedding the Proximity Sensor in metal, refer to *Influence of Surrounding Metal* on page 20.

\*2. Models with 5-m cable length are also available with "5M" suffix. (Example: E2E-X3D18 5M)

\*3. Models with a 2-m or 5-m robot (bending-resistant) cables are also available with "-R" in the model number. (Example: E2E-X3D18-R 2M/E2E-X3D18-R 5M)

\*4. Models with M12 Pre-wired Smartclick Connectors and robot (bending-resistant) cables are also available with "R" in the model number. (Example: E2E-X3D18-M1TGJR 0.3M/E2E-X3D18-M1TGJR-T 0.3M)

## Accessories (Sold Separately)

**e-jig (Mounting Sleeves)** [Refer to Dimensions on page 22.]

A Mounting Bracket is not provided with the Sensor. It must be ordered separately as required.

Appearance	Model	Applicable Sensor size	Applicable Sensor type
	Y92E-J8S12	M8	Triple distance model
	Y92E-J12S18	M12	Shielded models
	Y92E-J18S30	M18	Pre-wired models Standard body-sized

### Nut Sets

A Nut Set is included with the Sensor. Order a Nut Set when required, e.g., if you lose the nuts.

Model	Applicable Sensors	Applicable Sensor diameter	Set contents
Y92E-NWM08-E2EN	E2E NEXT Series Triple distance model (Shielded models)	M8	Clamping nuts (bronze with nickel plating): 2 Toothed washer (iron with zinc plating): 2
Y92E-NWM12-E2EN		M12	
Y92E-NWM18-E2EN		M18	
Y92E-NWM30-E2EN		M30	
Y92E-NWM08-E2E	E2E NEXT Series Triple distance model (Unshielded models)	M8	Clamping nuts (bronze with nickel plating): 2 Toothed washer (iron with zinc plating): 1
Y92E-NWM12-E2E		M12	
Y92E-NWM18-E2E		M18	
Y92E-NWM30-E2E		M30	

## Sensor I/O Connectors (Sold Separately)

For details of the connector, refer to XS5 NEXT Series Round Oil-resistant Connectors (M12 Smartclick) on page 84.

For details of the connector, refer to XS5 Series Round Water-resistant Connectors (M12 Smartclick) on page 87.

# E2E NEXT Series

## Ratings and Specifications

### DC 2-wire (Triple distance model)

Item	Size Shielded Model	M8		M12		M18		M30	
		Shielded	Unshielded	Shielded	Unshielded	Shielded	Unshielded	Shielded	Unshielded
		E2E-X3D□	E2E-X6MD□	E2E-X7D□	E2E-X10MD□	E2E-X11D□	E2E-X20MD□	E2E-X20D□	E2E-X40MD□
<b>Sensing distance</b>		3 mm ±10%	6 mm ±10%	7 mm ±10%	10 mm ±10%	11 mm ±10%	20 mm ±10%	20 mm ±10%	40 mm ±10%
<b>Setting distance *1</b>		0 to 2.4 mm	0 to 4.8 mm	0 to 5.6 mm	0 to 8 mm	0 to 8.8 mm	0 to 16 mm	0 to 16 mm	0 to 32 mm
<b>Differential travel</b>		15% max. of sensing distance							
<b>Detectable object</b>		Ferrous metal (The sensing distance decreases with non-ferrous metal. Refer to <i>Engineering Data</i> on page 17.)							
<b>Standard sensing object</b>		Iron, 9 × 9 × 1 mm	Iron, 18 × 18 × 1 mm	Iron, 21 × 21 × 1 mm	Iron, 30 × 30 × 1 mm	Iron, 33 × 33 × 1 mm	Iron, 60 × 60 × 1 mm	Iron, 60 × 60 × 1 mm	Iron, 120 × 120 × 1 mm
<b>Response frequency *2</b>		350 Hz	250 Hz	350 Hz	200 Hz	250 Hz	200 Hz	200 Hz	50 Hz
<b>Power supply voltage</b>		10 to 30 VDC, (including 10% ripple (p-p))							
<b>Leakage current</b>		0.8 mA max.							
<b>Control output</b>	<b>Load current</b>	3 to 100 mA							
	<b>Residual voltage</b>	Polarity: 3 V max. (Load current: 100 mA, Cable length: 2 m) No polarity: 5 V max. (Load current: 100 mA, Cable length: 2 m)							
<b>Indicator</b>		D1 Models: Operation indicator (orange), Setting indicator (green) D2 Models: Operation indicator (orange)							
<b>Operation mode</b>		D1 Models: NO      Refer to the timing charts under <i>I/O Circuit Diagrams</i> on page 18 for details. D2 Models: NC							
<b>Protection circuits</b>		Surge suppressor, Load short-circuit protection							
<b>Ambient temperature range</b>		Operating: -25 to 70°C, Storage: -40 to 85°C (with no icing or condensation)							
<b>Ambient humidity range</b>		Operating and Storage: 35% to 95% (with no condensation)							
<b>Temperature influence</b>		±10% max. of sensing distance at 23°C in the temperature range of -25 to 70°C				±20% max. of sensing distance at 23°C in the temperature range of -25 to 70°C	±10% max. of sensing distance at 23°C in the temperature range of -25 to 70°C	±20% max. of sensing distance at 23°C in the temperature range of -25 to 70°C	
<b>Voltage influence</b>		±1% max. of sensing distance at rated voltage in the rated voltage ±15% range							
<b>Insulation resistance</b>		50 MΩ min. (at 500 VDC) between current-carrying parts and case							
<b>Dielectric strength</b>		1,000 VAC, 50/60 Hz for 1 minute between current-carrying parts and case							
<b>Vibration resistance (destruction)</b>		10 to 55 Hz, 1.5-mm double amplitude for 2 hours each in X, Y, and Z directions							
<b>Shock resistance (destruction)</b>		500 m/s <sup>2</sup> 10 times each in X, Y, and Z directions		1,000 m/s <sup>2</sup> 10 times each in X, Y, and Z directions					
<b>Degree of protection</b>		Pre-wired Models/Pre-wired Connector Models: IP67 (IEC 60529), IP67G *3 (JIS C 0920 Annex 1) Passed OMRON's Oil-resistant Component Evaluation Standards *4 (Cutting oil type: specified in JIS K 2241:2000, Temperature: 35 °C max.) and ISO 20653 (old standard: DIN 40050 PART9) IP69K							
<b>Connecting method</b>		Pre-wired Models (Standard cable length: 2 m) and Pre-wired Connector Models (Standard cable length: 0.3 m)							
<b>Weight (packed state)</b>	<b>Pre-wired Models</b>	Approx. 60 g		Approx. 70 g		Approx. 130 g	Approx. 150 g	Approx. 180 g	Approx. 210 g
	<b>Pre-wired Connector Models</b>	Approx. 30 g		Approx. 40 g		Approx. 70 g	Approx. 90 g	Approx. 110 g	Approx. 140 g
<b>Materials</b>	<b>Case</b>	Nickel-plated brass	Stainless steel (SUS303)	Nickel-plated brass					
	<b>Sensing surface</b>	Polybutylene terephthalate (PBT)							
	<b>Clamping nuts</b>	Nickel-plated brass							
	<b>Toothed washer</b>	Zinc-plated iron							
<b>Cable</b>	Vinyl chloride (PVC)								
<b>Accessories</b>		Instruction manual, Clamping nuts, Toothed washer							

\*1. Use the Sensor within the range in which the setting indicator (green LED) is ON (except D2 Models).

\*2. The response frequency is an average value. Measurement conditions are as follows: standard sensing object, a distance of twice the standard sensing object, and a set distance of half the sensing distance.

\*3. The IP67G is the degree of protection which is defined according to the JIS (Japanese Industrial Standards).

The IP67 indicates the same level of protection as defined by the IEC, and the G indicates that a device has resistance to oil.

\*4. The Oil-resistant Component Evaluation Standards are OMRON's own durability evaluation standards.

2-year oil resistance indicates the median value of the product design and the oil-resistance performance criterion result (=Typical value).

The Pre-wired Connector Model verifies 2 years of oil resistance when mating with Round Oil-resistant Connectors XS5 NEXT series correctly.

The degree of protection is not satisfied with the part where cable wires are uncovered for the Pre-wired Models.



# Engineering Data (Reference Value)

## Sensing Area

Triple distance model  
Shielded Models

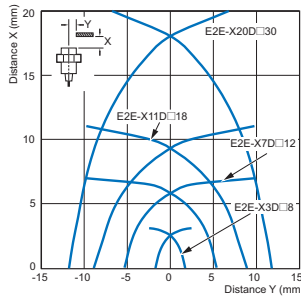

Unshielded Models

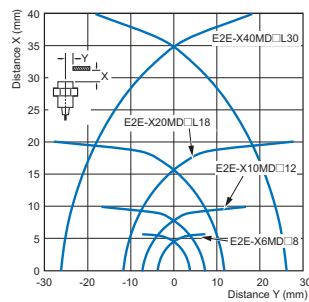

## Influence of Sensing Object Size and Materials

Triple distance model  
Shielded Models

Size: M8 E2E-X3D□8

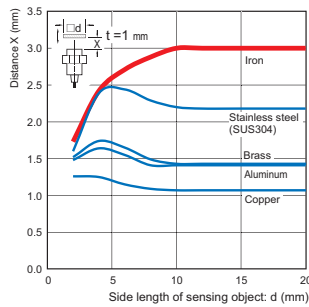

Size: M12 E2E-X7D□12

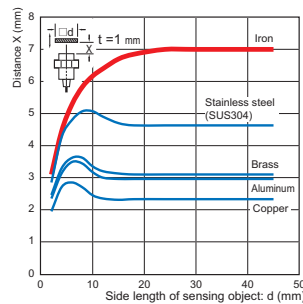

Size: M18 E2E-X11D□18

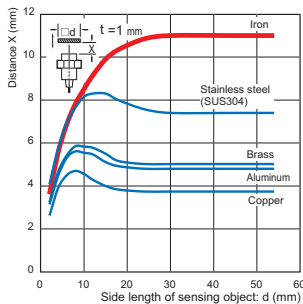

Size: M30 E2E-X20D□30

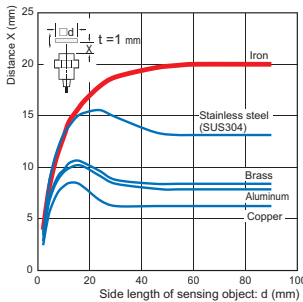

Unshielded Models

Size: M8 E2E-X6MD□8

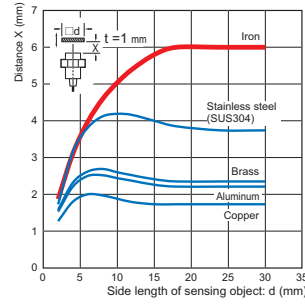

Size: M12 E2E-X10MD□12

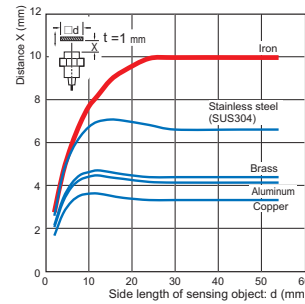

Size: M18 E2E-X20MD□L18

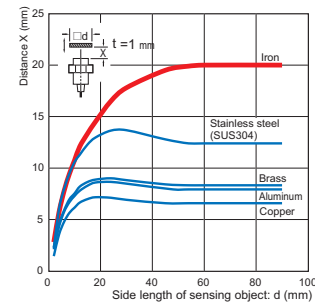

Size: M30 E2E-X40MD□L30

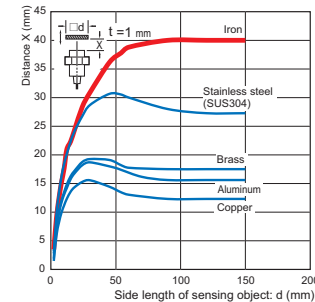

## Leakage Current

Triple distance model  
Shielded / Unshielded Models  
E2E-X□(M)D□(-T)

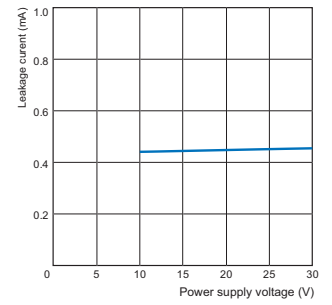

## Residual Output Voltage

Triple distance model  
Shielded / Unshielded Models  
E2E-X□(M)D□(-T)

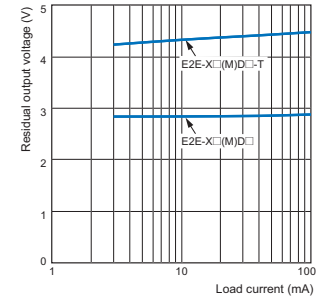

DC 2-wire  
Triple distance model

Standard/Double/Single distance model

DC 3-wire

XS5 NEXT Series

XS5

XS3

# E2E NEXT Series

## I/O Circuit Diagrams

### DC 2-wire Models (Triple distance model)

Operation mode	Model	Timing Chart	Output circuit
NO	E2E-X□D1□		<p>Note: The load can be connected to either the +V or 0 V side.</p>
	E2E-X□D1□-T		<p>Note1. The load can be connected to either the +V or 0 V side. 2. There is no polarity. Therefore, no need to be concerned about the polarity of brown and blue wires, or pins 3 and 4.</p>
NC	E2E-X□D2□		<p>Note: The load can be connected to either the +V or 0 V side.</p>
	E2E-X□D2□-T		<p>Note1. The load can be connected to either the +V or 0 V side. 2. There is no polarity. Therefore, no need to be concerned about the polarity of brown and blue wires, or pins 1 and 2.</p>

**Note:** For the Pre-wired Connector Models, the core wire color and pin number are different.

### Connector Pin Arrangement

#### M12 Smartclick Connector

-M1TGJ



## Safety Precautions

Be sure to read the precautions for all models in the website at: <http://www.ia.omron.com/>.

### Warning Indications

<b>⚠ WARNING</b>	<b>Warning level</b> Indicates a potentially hazardous situation which, if not avoided, will result in minor or moderate injury, or may result in serious injury or death. Additionally there may be significant property damage.
<b>Precautions for Safe Use</b>	Supplementary comments on what to do or avoid doing, to use the product safely.
<b>Precautions for Correct Use</b>	Supplementary comments on what to do or avoid doing, to prevent failure to operate, malfunction or undesirable effect on product performance.

### Meaning of Product Safety Symbols

	<b>General prohibition</b> Indicates the instructions of unspecified prohibited action.
	<b>Caution, explosion</b> Indicates the possibility of explosion under specific conditions.

### ⚠ WARNING

This product is not designed or rated for ensuring safety of persons either directly or indirectly. Do not use it for such purposes.



**Risk of explosion.**  
Do not connect sensor to AC power supply.



### Precautions for Safe Use

The following precautions must be observed to ensure safe operation.

- Do not use the product in an environment where flammable or explosive gas is present.
- Do not attempt to disassemble, repair, or modify the product.
- Do not use a voltage that exceeds the rated operating voltage range. Applying a voltage that is higher than the operating voltage range may result in damage or burnout.
- Be sure that the power supply polarity and other wiring is correct. Incorrect wiring may cause explosion or burnout.
- If the power supply is connected directly without a load, the internal elements may explode or burn. Be sure to insert a load when connecting the power supply.
- Dispose of the product according to applicable regulations (laws).

### Precautions for Correct Use

Do not use this product under ambient conditions that exceed the ratings.

#### Operating Environment

- Do not install the product in the following locations. Doing so may result in product failure or malfunction.
  - Outdoor locations directly subject to sunlight, rain, snow, water droplets, or oil.
  - Locations subject to atmospheres with chemical vapors, in particular solvents and acids.
  - Locations subject to corrosive gases.
- The Sensor may malfunction if used near ultrasonic cleaning equipment, high-frequency equipment, transceivers, cellular phones, inverters, or other devices that generate a high-frequency electric field. Please refer to the Precautions for Correct Use on the OMRON website ([www.ia.omron.com](http://www.ia.omron.com)) for typical measures.
- Laying the Proximity Sensor wiring in the same conduit or duct as high-voltage wires or power lines may result in incorrect operation and damage due to induction. Wire the Sensor using a separate conduit or independent conduit.
- Never use thinner or other solvents. Otherwise, the Sensor surface may be dissolved.
- The following conditions shall be observed if you use the product under an environment using cutting oil that may affect product's life and/or performance.
  - Usage under the cutting oil condition designated by the specification
  - Usage under the cutting oil dilution ratio recommended by its manufacturer
  - Usage in oil or water is prohibited
 Impact on the product life may differ depending on the oil you use. Before using the cutting oil, make sure that it should not cause deterioration or degradation of sealing components.

### AND Connection of Proximity Sensors

Two or more sensors cannot be connected in series on the AND circuit. Use them via a relay as shown on the figure.

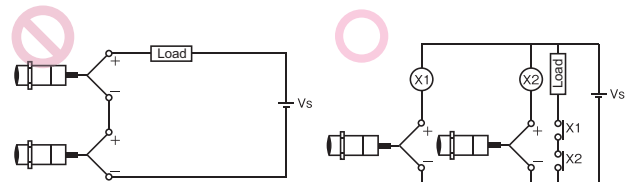

### OR Wiring of Proximity Sensors

As a general principle, two or more sensors cannot be used in parallel on the OR circuit. It is possible only when sensors do not operate simultaneously and loads do not need to be maintained. When loads need to be maintained, use the sensors via a relay as shown on the figure.

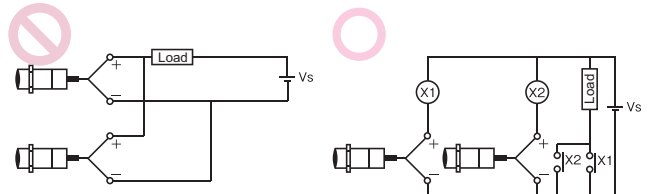

# E2E NEXT Series

## Design

### Influence of Surrounding Metal

When mounting the Proximity Sensor using a nut, only use the provided nut. And ensure that the minimum distances given in the following table are maintained.

When mounting the Proximity Sensor using a nut, only use the provided nut. Nuts that are supplied along with each Sensor are different. Refer to Dimensions for details on shapes.

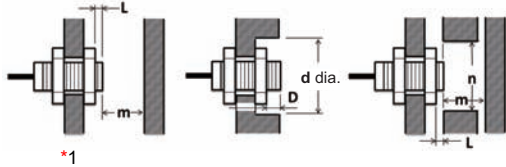

(Unit: mm)

### Shielded

Type	Size	Model	L	d	D	m	n
Triple distance model	M8	E2E-X3D□8	0	20	2	9	18
	M12	E2E-X7D□12	0	20	4	18	20
	M18	E2E-X11D□18	0	50	4	33	54
	M30	E2E-X20D□30	0	70	8	60	90

### Unshielded

Type	Size	Model	L	d	D	m	n
Triple distance model	M8	E2E-X6MD□8	10	30	13	18	30
	M12	E2E-X10MD□12	16	50	20	30	50
	M18	E2E-X20MD□18	31	90	35	60	80
	M30	E2E-X40MD□30	50 *1	170	55 *2	120	140

\*1. If you use the M30 Triple distance model of Unshielded Model, the panel thickness (t) is 4 mm or less.

\*2. Cannot be mounted if countersunk holes are used.

When the Proximity Sensor is mounted in metal, ensure that the minimum distances given in the following table are maintained.

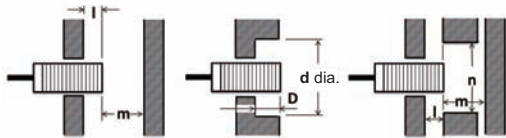

(Unit: mm)

### Shielded

Type	Size	Model	l	d	D	m	n
Triple distance model	M8	E2E-X3D□8	2	20	2	9	18
	M12	E2E-X7D□12	4	20	4	18	20
	M18	E2E-X11D□18	4	50	4	33	54
	M30	E2E-X20D□30	8	70	8	60	90

### Unshielded

Type	Size	Model	l	d	D	m	n
Triple distance model	M8	E2E-X6MD□8	13	30	13	18	30
	M12	E2E-X10MD□12	20	50	20	30	50
	M18	E2E-X20MD□18	35	90	35	60	80
	M30	E2E-X40MD□30	55	170	55	120	140

## Mutual Interference

When the Proximity Sensor is embedded in metal, ensure that the minimum distances given in the following table are maintained.

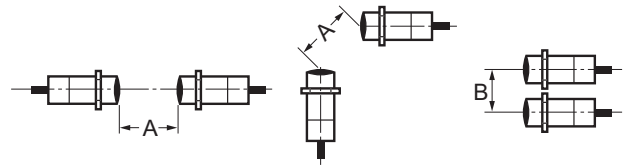

(Unit: mm)

### Shielded

Type	Size	Model	A	B
Triple distance model	M8	E2E-X3D□8	25	20
	M12	E2E-X7D□12	40	30
	M18	E2E-X11D□18	70	45
	M30	E2E-X20D□30	140	70

### Unshielded

Type	Size	Model	A	B
Triple distance model	M8	E2E-X6MD□8	80	60
	M12	E2E-X10MD□12	120	100
	M18	E2E-X20MD□18	200	120
	M30	E2E-X40MD□30	380	280

## Mounting

### Tightening Force

Do not tighten the sensor mounting nuts with excessive force.

Secure the mounting nuts to the corresponding torque values in the following table.

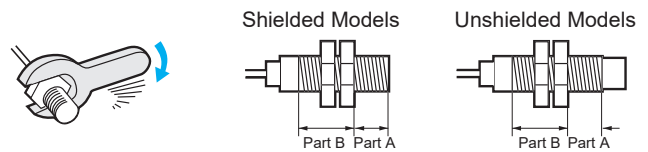

- Note:**
- The allowable tightening strength depends on the distance (A) from the edge of the head, as shown in the following table. (A is the distance from the edge of the head. B includes the nut on the head side. If the edge of the nut is in part A, the tightening torque for part A applies instead.)
  - The following strengths assume washers are being used.

### Triple distance model

Model	Part A		Part B
	Dimension (mm)	Torque	Torque
M8	Shielded	9	4 N·m
	Unshielded	3	
M12	Shielded	16	8 N·m
	Unshielded	9	
M18	Shielded	16	15 N·m
	Unshielded	3	
M30	Shielded	23	40 N·m
	Unshielded	8	

Dimensions

Sensor

DC 2-wire (Triple distance model)

Pre-wired Models  
Pre-wired Connector Models (Shielded)



Note: Refer to the figure below the table for the connections of the Pre-wired Connector Model.

E2E-X3D□8

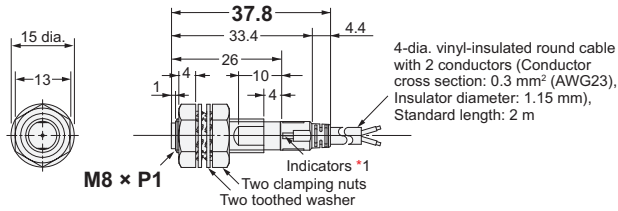

Pre-wired Models  
Pre-wired Connector Models (Unshielded)



Note: Refer to the figure below the table for the connections of the Pre-wired Connector Model.

E2E-X6MD□8

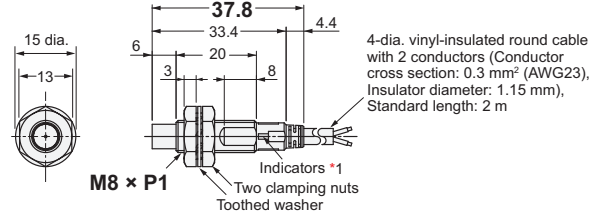

E2E-X7D□12

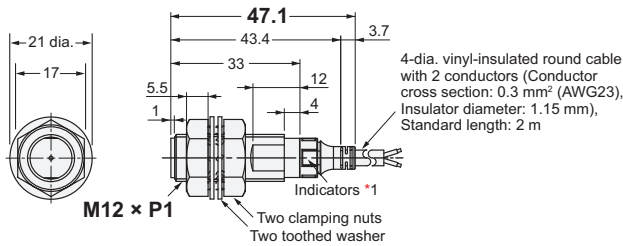

E2E-X10MD□12

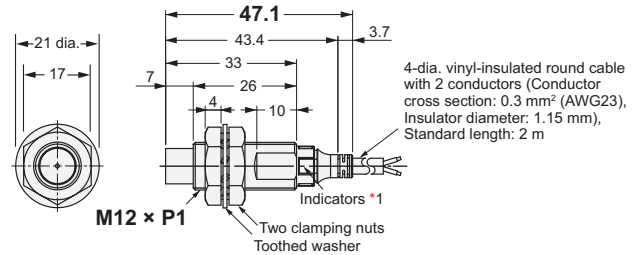

E2E-X11D□18

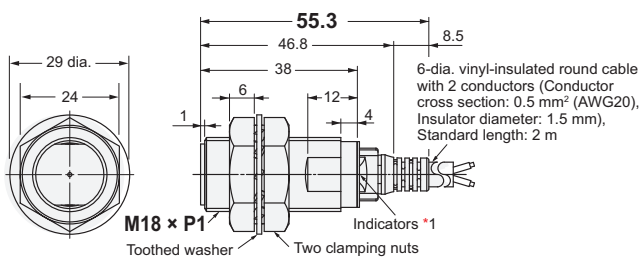

E2E-X20MD□18

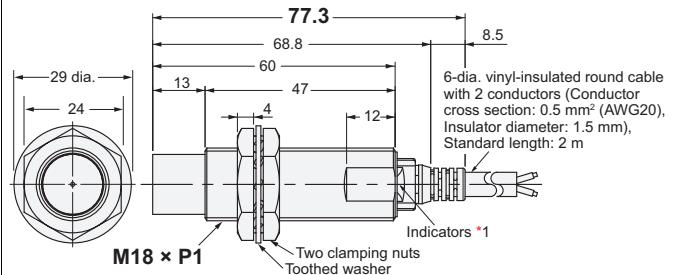

E2E-X20D□30

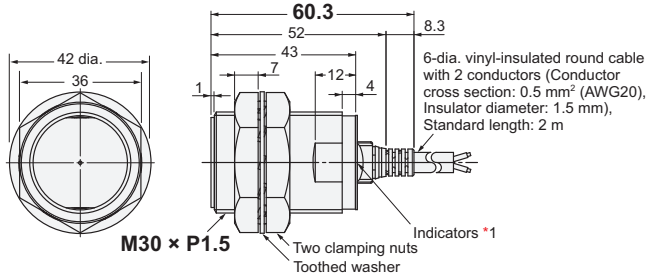

E2E-X40MD□L30

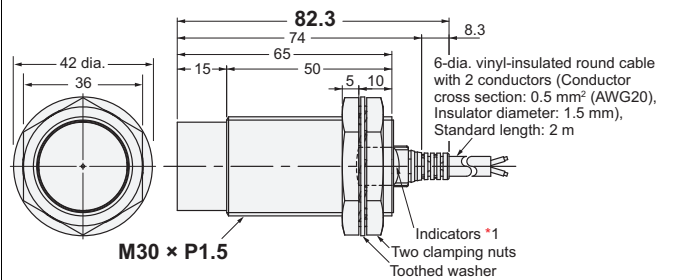

\*1. D1 Models: Operation indicator (Orange), Setting indicator (Green) / D2 Models: Operation indicator (Orange)

Pre-wired Connector Models (-M1TGJ)

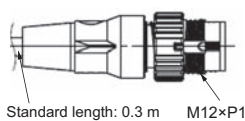

Note: Refer to the Pre-wired Model for the cable specifications of the Pre-wired Connector Model.

Mounting Hole Dimensions



Dimensions	F (mm)
M8	8.5 dia. <sup>+0.5</sup> / <sub>0</sub>
M12	12.5 dia. <sup>+0.5</sup> / <sub>0</sub>
M18	18.5 dia. <sup>+0.5</sup> / <sub>0</sub>
M30	30.5 dia. <sup>+0.5</sup> / <sub>0</sub>

Angle R of the Bending Wire



Dimensions	R (mm)
M8	12
M12	12
M18	18
M30	18

Wire pullout position



Dimensions	Sc (mm)
M8	- (0)
M12	- (0)
M18	2.5
M30	2.5

DC 2-wire Triple distance model

Standard/Double/Single distance model

DC 3-wire

XS5 NEXT Series

XS5

XS3

## Accessories (Sold Separately)

### e-jig (Mounting Sleeves)

#### Y92E-J8S12

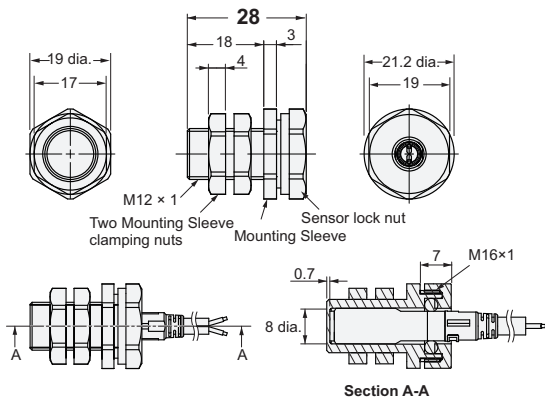

#### Y92E-J12S18

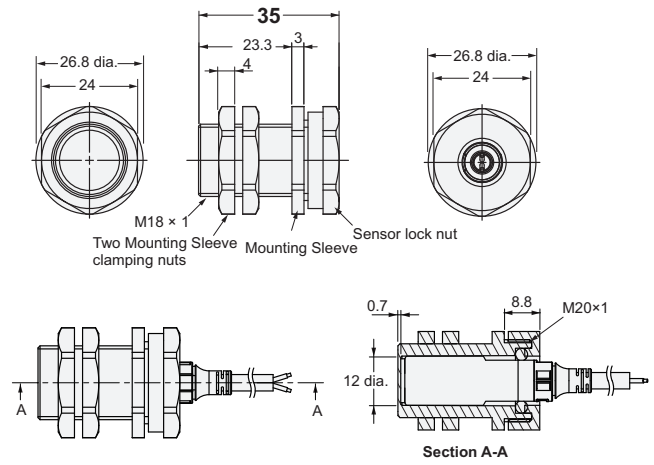

#### Y92E-J18S30

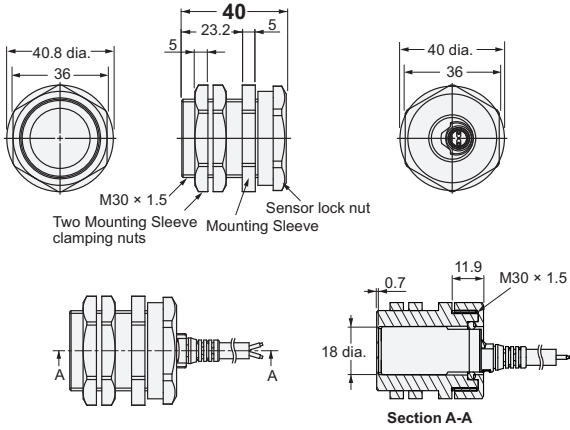

### Material

Mounting Sleeve	Polyetheretherketone (PEEK) / Polybutylene terephthalate (PBT)
Mounting Sleeve clamping nut	Polybutylene terephthalate (PBT)
Sensor lock nut	Polybutylene terephthalate (PBT)
Sensor lock O-ring	Material combining HNBR and fluororubber

### Tightening Force

Model	Torque	
	Mounting Sleeve clamping nut	Sensor lock nut
Y92E-J8S12	0.6 N·m	0.6 N·m
Y92E-J12S18	1.2 N·m	1.2 N·m
Y92E-J18S30	5 N·m	3.5 N·m

## Enhanced Usability Enables Installation without Special Skills and Shortens Commissioning and Recovery Time

- With high-brightness LED, the indicator is visible anywhere from 360°.
- Cables with enhanced oil resistance enabled 2-year oil resistance\*1.
- IP69K compliant for water resistance and wash resistance.
- UL certification (UL60947-5-2) and CSA certification (CSA C22.2 UL60947-5-2-14)

\*1. Refer to page 27 to 29 for details.

 Be sure to read *Safety Precautions* on page 33.



**Note:** Some models are not certified. For the most recent information on models that have been certified for safety standards, refer to your OMRON website.

## Model Number Legend

E2E - X (1) (2) D (3) (4) (5) - (6) - (7) (8) - (9) (10)

No.	Type	Code	Meaning
(1)	Sensing distance	Number	Sensing distance (Unit: mm) (R: Indication of decimal point)
(2)	Shielding	Blank	Shielded
		M	Unshielded
(3)	Operation mode	1	Normally open (NO)
		2	Normally closed (NC)
(4)	Oscillation frequency type	Blank	Standard frequency
		5	Different frequency
(5)	Body size	Blank	Standard
		L	Long-body
(6)	Connection method	Blank	Pre-wired Models
		M1	M12 Connector Models (Old pin arrangement)
		M1G	M12 Connector Models (IEC pin arrangement)
		M1J	M12 Pre-wired Standard Connector Models (Old pin arrangement)
		M1GJ	M12 Pre-wired Standard Connector Models (IEC pin arrangement)
		M1TJ	M12 Pre-wired Smartclick Connector Models (Old pin arrangement)
		M1TGJ	M12 Pre-wired Smartclick Connector Models (IEC pin arrangement)
		M1TGJR	M12 Pre-wired Smartclick Connector Models Robot (bending-resistant) cable (IEC pin arrangement)
(7)	Polarity	Blank	Polarity
		T	No polarity
(8)	Cable specifications (Only shown in the model number of Pre-wired Models.)	Blank	Standard PVC cable
		R	Robot (bending-resistant) PVC cable
(9)	New model	N	New model This is blank if the cable specification in number (8) is R.
(10)	Cable length	Number M	Cable length (Applicable to Pre-wired Models and Prewired Connector Models.)

**Note:** 1. The purpose of this model number legend is to provide understanding of the meaning of specifications from the model number.  
2. Pin arrangements vary depending on the model. Refer to *I/O Circuit Diagrams* on page 32 for details.

# E2E NEXT Series

## Ordering Information

### Sensors

DC 2-wire (Standard model) [Refer to *Dimensions* on page 35.]

#### Shielded Models

Size (Sensing distance)	Connection method	Body size	Polarity	Model	
				Operation mode: NO	Operation mode: NC
M8 (2mm)	Pre-wired (2 m)	38 mm	Yes	E2E-X2D1-N 2M *1 *2	E2E-X2D2-N 2M *1 *2
	M12 Pre-wired Smartclick Connector (0.3 m)	38 mm	Yes	E2E-X2D1-M1TGJ 0.3M *4 *5	---
	M12 Connector	43 mm	Yes	E2E-X2D1-M1G *5	E2E-X2D2-M1G *5
	M8 (4-pin) Connector	39 mm	Yes	E2E-X2D1-M3G	E2E-X2D2-M3G
M12 (3 mm)	Pre-wired (2 m)	47 mm	Yes	E2E-X3D1-N 2M *1 *2 *3	E2E-X3D2-N 2M *1 *2 *3
		69 mm		E2E-X3D1L 2M *1 *3	E2E-X3D2L 2M *1
	M12 Pre-wired Smartclick Connector (0.3 m)	47 mm	Yes	E2E-X3D1-M1TGJ 0.3M *4 *5	---
			No	E2E-X3D1-M1TJ-T 0.3M	---
	M12 Pre-wired Standard Connector (0.3 m)	47 mm	No	---	E2E-X3D2-M1GJ-T 0.3M
	M12 Connector	48 mm	Yes	E2E-X3D1-M1G *3 *5	E2E-X3D2-M1G *5
M18 (7 mm)	Pre-wired (2 m)	55 mm	Yes	E2E-X7D1-N 2M *1 *2 *3	E2E-X7D2-N 2M *1 *2 *3
		77 mm		E2E-X7D1L 2M *1 *3	E2E-X7D2L 2M *1
	M12 Pre-wired Smartclick Connector (0.3 m)	55 mm	Yes	E2E-X7D1-M1TGJ 0.3M *4 *5	---
			No	E2E-X7D1-M1TJ-T 0.3M	---
	M12 Pre-wired Standard Connector (0.3 m)	55 mm	No	---	E2E-X7D2-M1GJ-T 0.3M
	M12 Connector	53 mm	Yes	E2E-X7D1-M1G *3 *5	E2E-X7D2-M1G *5
M30 (10 mm)	Pre-wired (2 m)	60 mm	Yes	E2E-X10D1-N 2M *1 *2	E2E-X10D2-N 2M *1 *3
		82 mm		E2E-X10D1L 2M *1 *3	E2E-X10D2L 2M *1
	M12 Pre-wired Smartclick Connector (0.3 m)	60 mm	Yes	E2E-X10D1-M1TGJ 0.3M *3 *4 *5	---
			No	E2E-X10D1-M1TJ-T 0.3M	---
	M12 Connector	58 mm	Yes	E2E-X10D1-M1G *3 *5	E2E-X10D2-M1G *5

#### Unshielded Models

Size (Sensing distance)	Connection method	Body size	Polarity	Model	
				Operation mode: NO	Operation mode: NC
M8 (4 mm)	Pre-wired (2 m)	38 mm	Yes	E2E-X4MD1 2M *1 *2	E2E-X4MD2 2M *1 *2
	M12 Connector	43 mm	Yes	E2E-X4MD1-M1G *5	E2E-X4MD2-M1G *5
	M8 (4-pin) Connector	39 mm	Yes	E2E-X4MD1-M3G	E2E-X4MD2-M3G
M12 (8 mm)	Pre-wired (2 m)	47 mm	Yes	E2E-X8MD1 2M *1 *2	E2E-X8MD2 2M *1 *3
		69 mm		E2E-X8MD1L 2M *1 *3	E2E-X8MD2L 2M *1
	M12 Pre-wired Smartclick Connector (0.3 m)	47 mm	Yes	E2E-X8MD1-M1TGJ 0.3M *4 *5	---
	M12 Connector	48 mm	Yes	E2E-X8MD1-M1G *3 *5	E2E-X8MD2-M1G *5
M18 (14 mm)	Pre-wired (2 m)	55 mm	Yes	E2E-X14MD1 2M *1 *2 *3	E2E-X14MD2 2M *1 *2 *3
		77 mm		E2E-X14MD1L 2M *1 *3	E2E-X14MD2L 2M
	M12 Pre-wired Smartclick Connector (0.3 m)	55 mm	Yes	E2E-X14MD1-M1TGJ 0.3M *4 *5	---
		M12 Connector	53 mm	Yes	E2E-X14MD1-M1G *3 *5
M30 (20 mm)	Pre-wired (2 m)	60 mm	Yes	E2E-X20MD1 2M *1 *2 *3	E2E-X20MD2 2M *1 *3
		82 mm		E2E-X20MD1L 2M *1 *3	E2E-X20MD2L 2M *1
	M12 Pre-wired Smartclick Connector (0.3 m)	60 mm	Yes	E2E-X20MD1-M1TGJ 0.3M *4 *5	---
		M12 Connector	58 mm	Yes	E2E-X20MD1-M1G *3 *5

\*1. Models with 5-m cable length are also available with "5M" suffix. (Example: E2E-X2D1-N 5M)

\*2. Models with a 2-m or 5-m robot (bending-resistant) cables are also available with "-R" in the model number. (Example: E2E-X2D1-R 2M/E2E-X2D1-R 5M)

\*3. Models with different frequencies are also available. The model number is E2E-X□D□5. (Example: E2E-X3D15-N 2M/E2E-X3D15L 2M)

\*4. M12 Pre-wired Standard Connector Models with a 0.3-m cable are also available. The model numbers of models with IEC pin arrangement include "-M1GJ". (Example: E2E-X2D1-M1GJ 0.3M)

The model numbers of models with old pin arrangement include "-M1J". (Example: E2E-X2D1-M1J 0.3M)

Models with old pin arrangement of M12 Pre-wired Smartclick Connector Models are also available. The model numbers include "-M1TJ". (Example: E2E-X3D1-M1TJ 0.3M)

\*5. Models with old pin arrangement are also available. The model number is E2E-X□D□-M1. (Example: E2E-X2D1-M1)



## Sensors

DC 2-wire (Double distance model) [Refer to *Dimensions* on page 35.] **NEW**

## Shielded Models

Size (Sensing distance)	Connection method	Body size	Polarity	Model	
				Operation mode: NO	Operation mode: NC
M12 (4 mm)	Pre-wired (2 m)	47 mm	No	E2E-X4D1-T 2M *1	E2E-X4D2-T 2M *1
M18 (8 mm)	Pre-wired (2 m)	55 mm	No	E2E-X8D1-T 2M *1	E2E-X8D2-T 2M *1
M30 (15 mm)	Pre-wired (2 m)	60 mm	No	E2E-X15D1-T 2M *1	E2E-X15D2-T 2M *1

## Unshielded Models

Size (Sensing distance)	Connection method	Body size	Polarity	Model	
				Operation mode: NO	Operation mode: NC
M18 (16 mm)	Pre-wired (2 m)	77 mm	No	E2E-X16MD1L-T 2M *1	E2E-X16MD2L-T 2M
M30 (30 mm)	Pre-wired (2 m)	82 mm	No	E2E-X30MD1L-T 2M *1	E2E-X30MD2L-T 2M *1

\*1. Models with 5-m cable length are also available with "5M" suffix. (Example: E2E-X4D1-T 5M)

DC 2-wire (Single distance model) [Refer to *Dimensions* on page 38.]

## Shielded Models

Size (Sensing distance)	Connection method	Polarity	Model	
			Operation mode: NO	Operation mode: NC
M8 (1.5 mm)	Pre-wired (2 m) *2 *3	Yes	E2E-X1R5D1-N 2M	E2E-X1R5D2-N 2M
		No	E2E-X1R5D1-T-N 2M	E2E-X1R5D2-T-N 2M
	M12 Pre-wired Smartclick Connector (0.3 m) *4	Yes	E2E-X1R5D1-M1TGJ 0.3M	E2E-X1R5D2-M1TGJ 0.3M
		No	E2E-X1R5D1-M1TGJ-T 0.3M	E2E-X1R5D2-M1TGJ-T 0.3M
M12 (2.5 mm)	Pre-wired (2 m) *2 *3	Yes	E2E-X2R5D1-N 2M	E2E-X2R5D2-N 2M
		No	E2E-X2R5D1-T-N 2M	E2E-X2R5D2-T-N 2M
	M12 Pre-wired Smartclick Connector (0.3 m) *4	Yes	E2E-X2R5D1-M1TGJ 0.3M	E2E-X2R5D2-M1TGJ 0.3M
		No	E2E-X2R5D1-M1TGJ-T 0.3M	E2E-X2R5D2-M1TGJ-T 0.3M
M18 (5 mm)	Pre-wired (2 m) *2 *3	Yes	E2E-X5D1-N 2M	E2E-X5D2-N 2M
		No	E2E-X5D1-T-N 2M	E2E-X5D2-T-N 2M
	M12 Pre-wired Smartclick Connector (0.3 m) *4	Yes	E2E-X5D1-M1TGJ 0.3M	E2E-X5D2-M1TGJ 0.3M
		No	E2E-X5D1-M1TGJ-T 0.3M	E2E-X5D2-M1TGJ-T 0.3M

\*1. Models with 5-m cable length are also available with "5M" suffix. (Example: E2E-X1R5D1-N 5M)

\*2. Models with a 2-m or 5-m robot (bending-resistant) cables are also available with "-R" in the model number. (Example: E2E-X1R5D1-R-N 2M/ E2E-X1R5D1-R-N 5M)

\*3. Models with M12 Smartclick connector model robot (bending-resistant) cables are also available with "R" in the model number. (Example: E2E-X1R5D1-M1TGJR 0.3M/E2E-X1R5D1-M1TGJR-T 0.3M)

## E2E NEXT Series

### Accessories (Sold Separately)

#### Nut Sets

A Nut Set is included with the Sensor. Order a Nut Set when required, e.g., if you lose the nuts.

Model	Applicable Sensors	Applicable Sensor diameter	Set contents
Y92E-NWM08-E2E	E2E NEXT Series Standard model (Shielded/Unshielded Models) Single distance model (Shielded Models)	M8	Clamping nuts (bronze with nickel plating): 2 Toothed washer (iron with zinc plating): 1
Y92E-NWM12-E2E	E2E NEXT Series Standard model (Shielded/Unshielded Models) Double distance model (Shielded Models) Single distance model (Shielded Models)	M12	
Y92E-NWM18-E2E	E2E NEXT Series Standard model (Shielded/Unshielded Models) Double distance model (Shielded/Unshielded Models) Single distance model (Shielded Models)	M18	
Y92E-NWM30-E2E	E2E NEXT Series Standard model (Shielded/Unshielded Models) Double distance model (Shielded/Unshielded Models)	M30	

### Sensor I/O Connectors (Sold Separately)

For details of the connector, refer to XS5 NEXT Series Round Oil-resistant Connectors (M12 Smartclick) on page 84.

For details of the connector, refer to XS5 Series Round Water-resistant Connectors (M12 Smartclick) on page 87.

For details of the connector, refer to XS3 Series Round Water-resistant Connectors (M8) on page 91.

## Ratings and Specifications

## DC 2-wire (Standard model)

Item	Size		M8		M12		M18		M30	
	Shielded	Model	Shielded	Unshielded	Shielded	Unshielded	Shielded	Unshielded	Shielded	Unshielded
			E2E-X2D□	E2E-X4MD□	E2E-X3D□	E2E-X8MD□	E2E-X7D□	E2E-X14MD□	E2E-X10D□	E2E-X20MD□
<b>Sensing distance</b>			2 mm ±10%	4 mm ±10%	3 mm ±10%	8 mm ±10%	7 mm ±10%	14 mm ±10%	10 mm ±10%	20 mm ±10%
<b>Setting distance *1</b>			0 to 1.6 mm	0 to 3.2 mm	0 to 2.4 mm	0 to 6.4 mm	0 to 5.6 mm	0 to 11.2 mm	0 to 8 mm	0 to 16 mm
<b>Differential travel</b>			15% max. of sensing distance		10% max. of sensing distance					
<b>Detectable object</b>	Ferrous metal (The sensing distance decreases with non-ferrous metal. Refer to <i>Engineering Data</i> on page 30.)									
<b>Standard sensing object</b>			Iron, 8 × 8 × 1 mm	Iron, 20 × 20 × 1 mm	Iron, 12 × 12 × 1 mm	Iron, 30 × 30 × 1 mm	Iron, 18 × 18 × 1 mm	Iron, 30 × 30 × 1 mm	Iron, 30 × 30 × 1 mm	Iron, 54 × 54 × 1 mm
<b>Response frequency *2</b>			1.5 kHz	1 kHz	1 kHz	0.8 kHz	0.5 kHz	0.4 kHz	0.4 kHz	0.1 kHz
<b>Power supply voltage</b>	12 to 24 VDC (including 10% ripple (p-p)), Class 2									
<b>Leakage current</b>	0.8 mA max.									
<b>Control output</b>	<b>Load current</b>	3 to 100 mA								
	<b>Residual voltage</b>	Polarity: 3 V max. (Load current: 100 mA, Cable length: 2 m) No polarity: 5 V max. (Load current: 100 mA, Cable length: 2 m)								
<b>Indicator</b>	D1 Models: Operation indicator (orange), Setting indicator (green) D2 Models: Operation indicator (orange)									
<b>Operation mode</b>	D1 Models: NO    Refer to the timing charts under <i>I/O Circuit Diagrams</i> on page 32 for details. D2 Models: NC									
<b>Protection circuits</b>	Surge suppressor, Load short-circuit protection									
<b>Ambient temperature range</b>	Operating: -25 to 70°C, Storage: -40 to 85°C (with no icing or condensation)									
<b>Ambient humidity range</b>	Operating and Storage: 35% to 95% (with no condensation)									
<b>Temperature influence</b>	±10% max. of sensing distance at 23°C in the temperature range of -25 to 70°C									
<b>Voltage influence</b>	±1% max. of sensing distance at rated voltage in the rated voltage ±15% range									
<b>Insulation resistance</b>	50 MΩ min. (at 500 VDC) between current-carrying parts and case									
<b>Dielectric strength</b>	1,000 VAC, 50/60 Hz for 1 minute between current-carrying parts and case									
<b>Vibration resistance (destruction)</b>	10 to 55 Hz, 1.5-mm double amplitude for 2 hours each in X, Y, and Z directions									
<b>Shock resistance (destruction)</b>	500 m/s <sup>2</sup> 10 times each in X, Y, and Z directions				1,000 m/s <sup>2</sup> 10 times each in X, Y, and Z directions					
<b>Degree of protection</b>	Pre-wired Models/Pre-wired Connector Models: IP67 (IEC 60529), IP67G *3 (JIS C 0920 Annex 1) Passed OMRON's Oil-resistant Component Evaluation Standards *4 (Cutting oil type: specified in JIS K 2241:2000, Temperature: 35°C max.) and ISO 20653 (old standard: DIN 40050 PART9) IP69K									
<b>Connecting method</b>	Pre-wired Models (Standard cable length: 2 m), Pre-wired Connector Models (Standard cable length: 0.3 m), M8 Connector Models and M12 Connector Models									
<b>Weight *5 (packed state)</b>	<b>Pre-wired Models</b>	Approx. 60 g			Approx. 70 g		Approx. 130 g	Approx. 150 g	Approx. 180 g	Approx. 210 g
	<b>Pre-wired Connector Models</b>	Approx. 30 g			Approx. 40 g		Approx. 70 g	Approx. 90 g	Approx. 110 g	Approx. 140 g
	<b>Connector Models</b>	Approx. 40 g (M8/M12 Connector)			Approx. 55 g		Approx. 85 g	Approx. 80 g	Approx. 160 g	Approx. 150 g
<b>Materials</b>	<b>Case</b>	M8 Size: Stainless steel (SUS303), M12/M18/M30 Size: Nickel-plated brass								
	<b>Sensing surface</b>	Polybutylene terephthalate (PBT)								
	<b>Clamping nuts</b>	Nickel-plated brass								
	<b>Toothed washer</b>	Zinc-plated iron								
	<b>Cable</b>	Vinyl chloride (PVC)    Note: Material of Pre-wired Models and Pre-wired Connector Models.								
<b>Accessories</b>	Instruction manual, Clamping nuts, Toothed washer									

\*1. Use the Sensor within the range in which the setting indicator (green LED) is ON (except D2 Models).

\*2. The response frequency is an average value. Measurement conditions are as follows: standard sensing object, a distance of twice the standard.

\*3. The IP67G is the degree of protection which is defined according to the JIS (Japanese Industrial Standards). The IP67 indicates the same level of protection as defined by the IEC, and the G indicates that a device has resistance to oil.

\*4. The Oil-resistant Component Evaluation Standards are OMRON's own durability evaluation standards. 2-year oil resistance indicates the median value of the product design and the oil-resistance performance criterion result (=Typical value). The Pre-wired Connector Model verifies 2 years of oil resistance when mating with Round Oil-resistant Connectors XS5 NEXT series correctly. The degree of protection is not satisfied with the part where cable wires are uncovered for the Pre-wired Models.

\*5. Weight of the standard body-sized model.

Triple distance model

Standard/Double/Single distance model

DC 2-wire

DC 3-wire

XS5

XS5

# E2E NEXT Series

## DC 2-wire (Double distance model)

Item	Size Shielded Model	M12		M18		M30	
		Shielded	Unshielded	Shielded	Shielded	Unshielded	Unshielded
		E2E-X4D□	E2E-X8D□	E2E-X16MD□	E2E-X15D□	E2E-X30MD□	
Sensing distance		4 mm ±10%	8 mm ±10%	16 mm ±10%	15 mm ±10%	30 mm ±10%	
Setting distance *1		0 to 3.2 mm	0 to 6.4 mm	0 to 12.8 mm	0 to 12 mm	0 to 24 mm	
Differential travel		15% max. of sensing distance					
Detectable object		Ferrous metal (The sensing distance decreases with non-ferrous metal. Refer to <i>Engineering Data</i> on page 30.)					
Standard sensing object		Iron, 12 × 12 × 1 mm	Iron, 18 × 18 × 1 mm	Iron, 45 × 45 × 1 mm	Iron, 30 × 30 × 1 mm	Iron, 70 × 70 × 1 mm	
Response frequency *2		1 kHz	0.5 kHz	0.4 kHz	0.25 kHz	0.1 kHz	
Power supply voltage		12 to 24 VDC (including 10% ripple (p-p)), Class 2					
Leakage current		0.8 mA max.					
Control output	Load current	3 to 100 mA					
	Residual voltage	5 V max. (Load current: 100 mA, Cable length: 2 m)					
Indicator		D1 Models: Operation indicator (orange), Setting indicator (green) D2 Models: Operation indicator (orange)					
Operation mode		D1 Models: NO      Refer to the timing charts under <i>I/O Circuit Diagrams</i> on page 32 for details. D2 Models: NC					
Protection circuits		Surge suppressor, Load short-circuit protection					
Ambient temperature range		Operating: -25 to 70°C, Storage: -40 to 85°C (with no icing or condensation)					
Ambient humidity range		Operating and Storage: 35% to 95% (with no condensation)					
Temperature influence		±10% max. of sensing distance at 23°C in the temperature range of -25 to 70°C					
Voltage influence		±1% max. of sensing distance at rated voltage in the rated voltage ±15% range					
Insulation resistance		50 MΩ min. (at 500 VDC) between current-carrying parts and case					
Dielectric strength		1,000 VAC, 50/60 Hz for 1 minute between current-carrying parts and case					
Vibration resistance (destruction)		10 to 55 Hz, 1.5-mm double amplitude for 2 hours each in X, Y, and Z directions					
Shock resistance (destruction)		500 m/s <sup>2</sup> 10 times each in X, Y, and Z directions	1,000 m/s <sup>2</sup> 10 times each in X, Y, and Z directions				
Degree of protection		Pre-wired Models/Pre-wired Connector Models: IP67 (IEC 60529), IP67G *3 (JIS C 0920 Annex 1) Passed OMRON's Oil-resistant Component Evaluation Standards *4 (Cutting oil type: specified in JIS K 2241:2000, Temperature: 35°C max.) and ISO 20653 (old standard: DIN 40050 PART9) IP69K					
Connecting method		Pre-wired Models (Standard cable length: 2 m), Pre-wired Connector Models (Standard cable length: 0.3 m)					
Weight (packed state)	Pre-wired Models	Approx. 70 g	Approx. 130 g	Approx. 150 g	Approx. 180 g	Approx. 210 g	
	Pre-wired Connector Models	Approx. 40 g	Approx. 70 g	Approx. 90 g	Approx. 110 g	Approx. 140 g	
Materials	Case	Nickel-plated brass					
	Sensing surface	Polybutylene terephthalate (PBT)					
	Clamping nuts	Nickel-plated brass					
	Toothed washer	Zinc-plated iron					
	Cable	Vinyl chloride (PVC)					
Accessories		Instruction manual, Clamping nuts, Toothed washer					

\*1. Use the Sensor within the range in which the setting indicator (green LED) is ON (except D2 Models).

\*2. The response frequency is an average value. Measurement conditions are as follows: standard sensing object, a distance of twice the standard.

\*3. The IP67G is the degree of protection which is defined according to the JIS (Japanese Industrial Standards). The IP67 indicates the same level of protection as defined by the IEC, and the G indicates that a device has resistance to oil.

\*4. The Oil-resistant Component Evaluation Standards are OMRON's own durability evaluation standards. 2-year oil resistance indicates the median value of the product design and the oil-resistance performance criterion result (=Typical value). The Pre-wired Connector Model verifies 2 years of oil resistance when mating with Round Oil-resistant Connectors XS5 NEXT series correctly. The degree of protection is not satisfied with the part where cable wires are uncovered for the Pre-wired Models.

## DC 2-wire (Single distance model)

Item	Size Shielded Model	M8	M12	M18
		Shielded		
		E2E-X1R5D□	E2E-X2R5D□	E2E-X5D□
Sensing distance		1.5 mm ±10%	2.5 mm ±10%	5 mm ±10%
Setting distance *1		0 to 1.2 mm	0 to 2 mm	0 to 4 mm
Differential travel		10% max. of sensing distance		
Detectable object		Ferrous metal (The sensing distance decreases with non-ferrous metal. Refer to <i>Engineering Data</i> on page 30.)		
Standard sensing object		Iron, 10 × 10 × 1 mm	Iron, 12 × 12 × 1 mm	Iron, 18 × 18 × 1 mm
Response frequency *2		250 Hz	250 Hz	250 Hz
Power supply voltage		10 to 30 VDC, (including 10% ripple (p-p))		
Leakage current		0.8 mA max.		
Control output	Load current	3 to 100 mA		
	Residual voltage	Polarity: 3 V max. (Load current: 100 mA, Cable length: 2 m) No polarity: 5 V max. (Load current: 100 mA, Cable length: 2 m)		
Indicator		D1 Models: Operation indicator (orange), Setting indicator (green) D2 Models: Operation indicator (orange)		
Operation mode		D1 Models: NO      Refer to the timing charts under <i>I/O Circuit Diagrams</i> on page 32 for details. D2 Models: NC		
Protection circuits		Surge suppressor, Load short-circuit protection		
Ambient temperature range		Operating: -25 to 70°C, Storage: -40 to 85°C (with no icing or condensation)		
Ambient humidity range		Operating and Storage: 35% to 95% (with no condensation)		
Temperature influence		±10% max. of sensing distance at 23°C in the temperature range of -25 to 70°C		
Voltage influence		±1% max. of sensing distance at rated voltage in the rated voltage ±15% range		
Insulation resistance		50 MΩ min. (at 500 VDC) between current-carrying parts and case		
Dielectric strength		1,000 VAC, 50/60 Hz for 1 minute between current-carrying parts and case		
Vibration resistance (destruction)		10 to 55 Hz, 1.5-mm double amplitude for 2 hours each in X, Y, and Z directions		
Shock resistance (destruction)		500 m/s <sup>2</sup> 10 times each in X, Y, and Z directions	1,000 m/s <sup>2</sup> 10 times each in X, Y, and Z directions	
Degree of protection		Pre-wired Models/Pre-wired Connector Models: IP67 (IEC 60529), IP67G *3 (JIS C 0920 Annex 1) Passed OMRON's Oil-resistant Component Evaluation Standards *4 (Cutting oil type: specified in JIS K 2241:2000, Temperature: 35°C max.) and ISO 20653 (old standard: DIN 40050 PART9) IP69K		
Connecting method		Pre-wired Models (Standard cable length: 2 m) and Pre-wired Connector Models (Standard cable length: 0.3 m)		
Weight (packed state)	Pre-wired Models	Approx. 60 g	Approx. 70 g	Approx. 130 g
	Pre-wired Connector Models	Approx. 30 g	Approx. 40 g	Approx. 70 g
Materials	Case	Stainless steel (SUS303)	Nickel-plated brass	
	Sensing surface	Polybutylene terephthalate (PBT)		
	Clamping nuts	Nickel-plated brass		
	Toothed washer	Zinc-plated iron		
	Cable	Vinyl chloride (PVC)		
Accessories		Instruction manual, Clamping nuts, Toothed washer		

\*1. Use the Sensor within the range in which the setting indicator (green LED) is ON (except D2 Models).

\*2. The response frequency is an average value. Measurement conditions are as follows: standard sensing object, a distance of twice the standard.

\*3. The IP67G is the degree of protection which is defined according to the JIS (Japanese Industrial Standards). The IP67 indicates the same level of protection as defined by the IEC, and the G indicates that a device has resistance to oil.

\*4. The Oil-resistant Component Evaluation Standards are OMRON's own durability evaluation standards. 2-year oil resistance indicates the median value of the product design and the oil-resistance performance criterion result (=Typical value). The Pre-wired Connector Model verifies 2 years of oil resistance when mating with Round Oil-resistant Connectors XS5 NEXT series correctly. The degree of protection is not satisfied with the part where cable wires are uncovered for the Pre-wired Models.

# E2E NEXT Series

## Engineering Data (Reference Value)

### Sensing Area

#### Standard model

##### Shielded

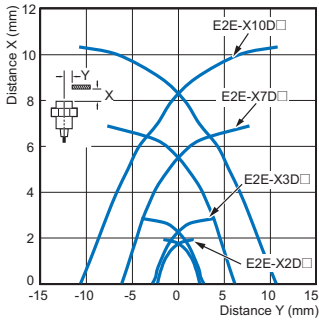

#### Double distance model

##### Shielded

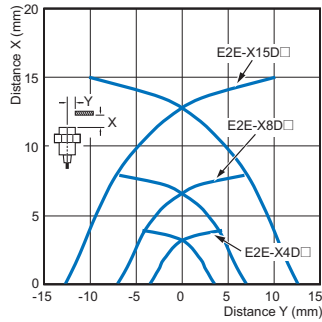

##### Unshielded

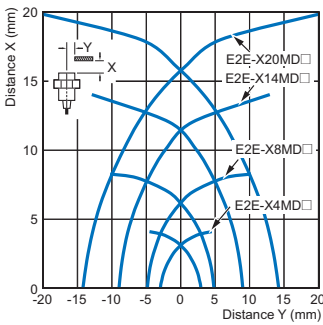

##### Unshielded

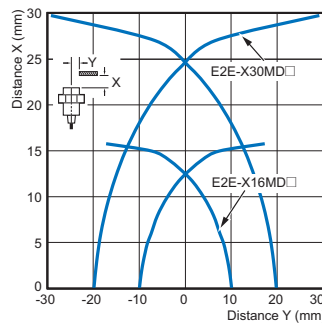

#### Single distance model

##### Shielded

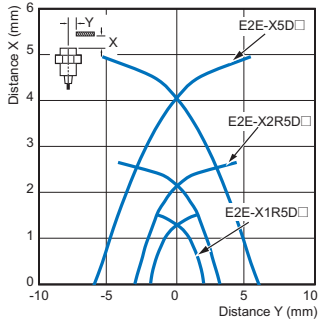

### Influence of Sensing Object Size and Materials

#### Standard model

##### Shielded

Size: M8 E2E-X2D

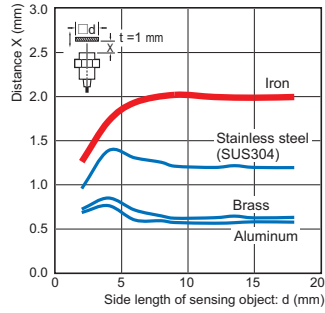

##### Unshielded

Size: M8 E2E-X4MD

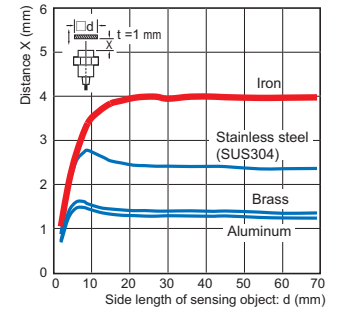

Size: M12 E2E-X3D

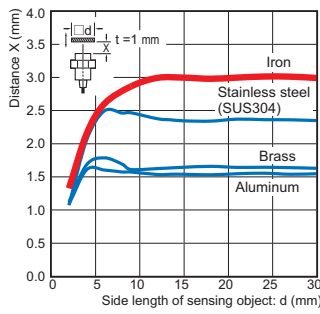

Size: M12 E2E-X8MD

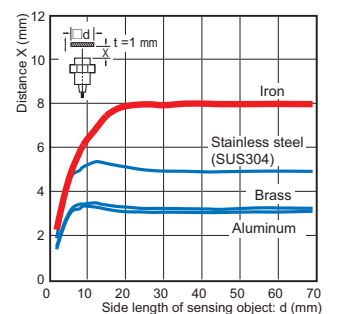

Size: M18 E2E-X7D

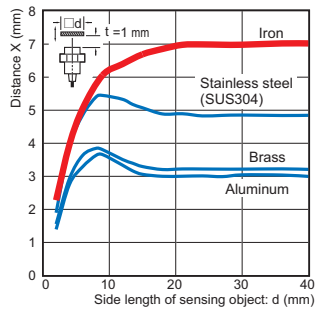

Size: M18 E2E-X14MD

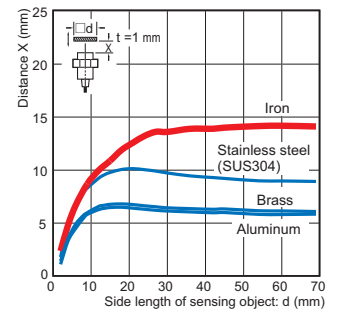

Size: M30 E2E-X10D

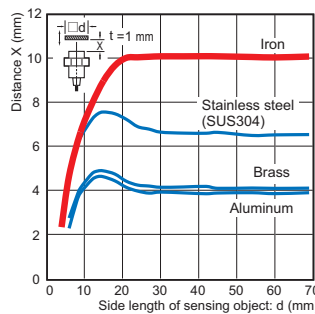

Size: M30 E2E-X20MD

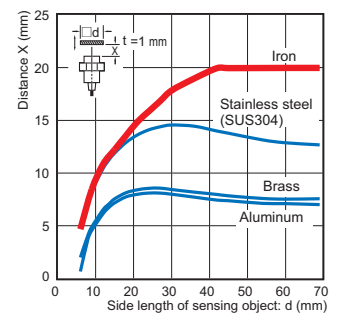

Influence of Sensing Object Size and Materials

Double distance model  
Shielded

Size: M12 E2E-X4D□

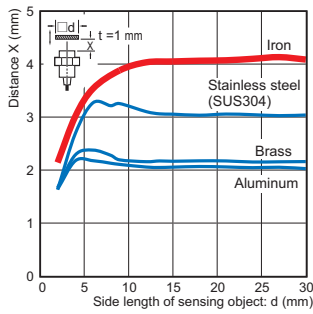

Unshielded

Size: M18 E2E-X16MD□

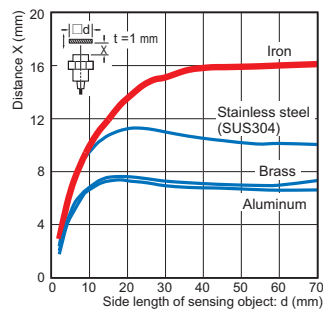

Single distance model  
Shielded

Size: M8 E2E-X1R5D□

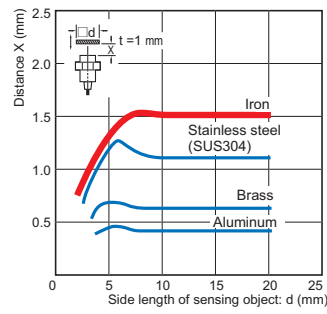

Leakage Current

Standard/Double distance/  
Single distance model  
Shielded/Unshielded  
E2E-X□(M)D□(-T)

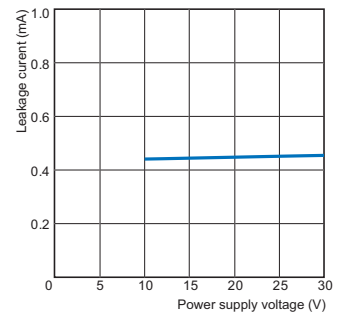

Size: M18 E2E-X8D□

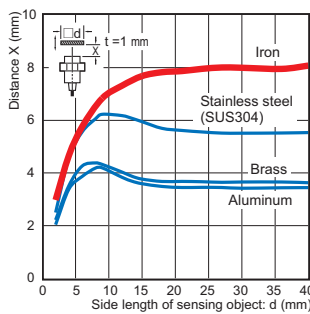

Size: M30 E2E-X30MD□

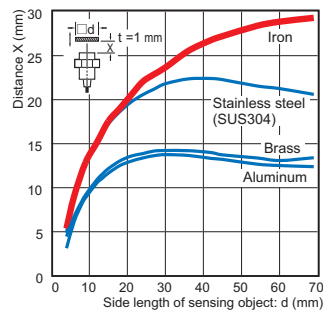

Size: M12 E2E-X2R5D□

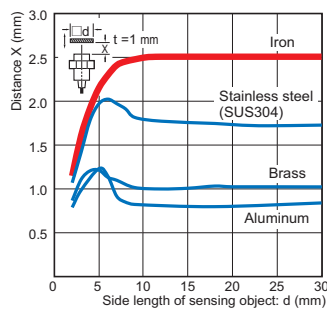

Residual Output Voltage  
Standard/Double distance/  
Single distance model  
Shielded/Unshielded  
E2E-X□(M)D□(-T)

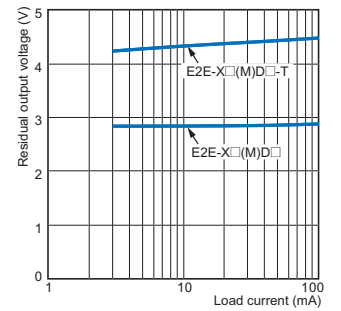

Size: M30 E2E-X15D□

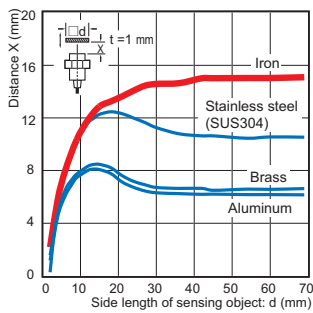

Size: M18 E2E-X5D□

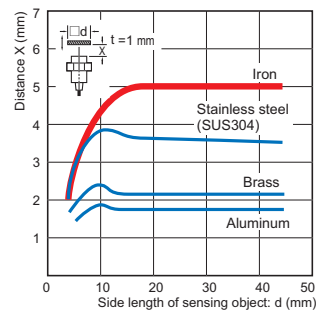

# E2E NEXT Series

## I/O Circuit Diagrams

### DC 2-wire (Standard/Double distance/Single distance model)

Operation mode	Model	Timing Chart	Output circuit
NO	E2E-X□D1 E2E-X□D1-M1(T)(J) E2E-X□D1-M3G		
	E2E-X□D1-M1(T)J		
	E2E-X□D1-T E2E-X□D1-M1(T)(J)-T (Standard/Double distance model) E2E-X□D1-M1(T)G(J)-T (Single distance model)		
	E2E-X□D1-M1(T)G(J)-T (Standard/Double distance model)		
NC	E2E-X□D2 E2E-X□D2-M1(T)G(J) E2E-X□D2-M3G		
	E2E-X□D2-M1(T)J		
	E2E-X□D2-T E2E-X□D2-M1(T)(J)-T (Standard/Double distance model) E2E-X□D2-M1(T)G(J)-T (Single distance model)		
	E2E-X□D2-M1(T)G(J)-T (Standard/Double distance model)		

**Note:** For the Pre-wired Connector Models, the core wire color and pin number are different.

### Connector Pin Arrangement

M12 Connector M12 Smartclick Connector	M8 (4-pin) Connector
-M1/M1G -M1T□□ 	-M3G 



## Safety Precautions

Be sure to read the precautions for all models in the website at: <http://www.ia.omron.com/>.

### Warning Indications

<b>⚠ WARNING</b>	<b>Warning level</b> Indicates a potentially hazardous situation which, if not avoided, will result in minor or moderate injury, or may result in serious injury or death. Additionally there may be significant property damage.
<b>Precautions for Safe Use</b>	Supplementary comments on what to do or avoid doing, to use the product safely.
<b>Precautions for Correct Use</b>	Supplementary comments on what to do or avoid doing, to prevent failure to operate, malfunction or undesirable effect on product performance.

### Meaning of Product Safety Symbols

	<b>General prohibition</b> Indicates the instructions of unspecified prohibited action.
	<b>Caution, explosion</b> Indicates the possibility of explosion under specific conditions.

### ⚠ WARNING

This product is not designed or rated for ensuring safety of persons either directly or indirectly. Do not use it for such purposes.



**Risk of explosion.**  
Do not connect sensor to AC power supply.



### Precautions for Safe Use

The following precautions must be observed to ensure safe operation.

- Do not use the product in an environment where flammable or explosive gas is present.
- Do not attempt to disassemble, repair, or modify the product.
- Do not use a voltage that exceeds the rated operating voltage range. Applying a voltage that is higher than the operating voltage range may result in damage or burnout.
- Be sure that the power supply polarity and other wiring is correct. Incorrect wiring may cause explosion or burnout.
- If the power supply is connected directly without a load, the internal elements may explode or burn. Be sure to insert a load when connecting the power supply.
- Dispose of the product according to applicable regulations (laws).

### Precautions for Correct Use

Do not use this product under ambient conditions that exceed the ratings.

#### Operating Environment

- Do not install the product in the following locations. Doing so may result in product failure or malfunction.
  - Outdoor locations directly subject to sunlight, rain, snow, water droplets, or oil.
  - Locations subject to atmospheres with chemical vapors, in particular solvents and acids.
  - Locations subject to corrosive gases.
- The Sensor may malfunction if used near ultrasonic cleaning equipment, high-frequency equipment, transceivers, cellular phones, inverters, or other devices that generate a high-frequency electric field. Please refer to the Precautions for Correct Use on the OMRON website ([www.ia.omron.com](http://www.ia.omron.com)) for typical measures.
- Laying the Proximity Sensor wiring in the same conduit or duct as high-voltage wires or power lines may result in incorrect operation and damage due to induction. Wire the Sensor using a separate conduit or independent conduit.
- Never use thinner or other solvents. Otherwise, the Sensor surface may be dissolved.
- The following conditions shall be observed if you use the product under an environment using cutting oil that may affect product's life and/or performance.
  - Usage under the cutting oil condition designated by the specification
  - Usage under the cutting oil dilution ratio recommended by its manufacturer
  - Usage in oil or water is prohibited
 Impact on the product life may differ depending on the oil you use. Before using the cutting oil, make sure that it should not cause deterioration or degradation of sealing components.

#### AND Connection of Proximity Sensors

Two or more sensors cannot be connected in series on the AND circuit. Use them via a relay as shown on the figure.

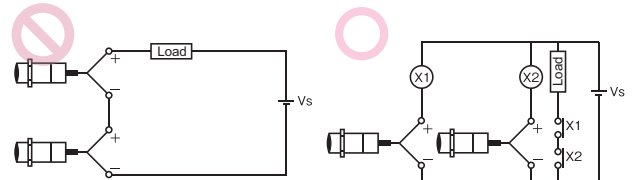

#### OR Wiring of Proximity Sensors

As a general principle, two or more sensors cannot be used in parallel on the OR circuit. It is possible only when sensors do not operate simultaneously and loads do not need to be maintained. When loads need to be maintained, use the sensors via a relay as shown on the figure.

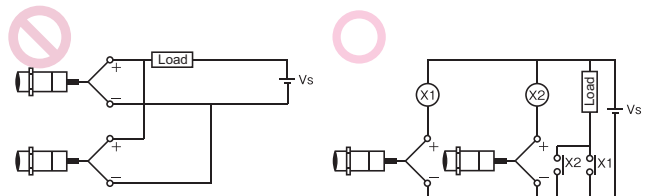

# E2E NEXT Series

## Design

### Influence of Surrounding Metal

When mounting the Proximity Sensor using a nut, only use the provided nut. And ensure that the minimum distances given in the following table are maintained.

When mounting the Proximity Sensor using a nut, only use the provided nut. Nuts that are supplied along with each Sensor are different. Refer to Dimensions for details on shapes.

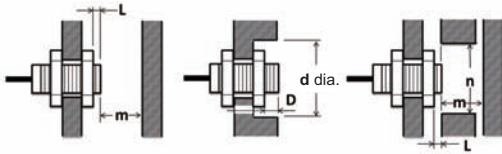

(Unit: mm)

### Shielded

Type	Size	Model	L	d	D	m	n
Standard model	M8	E2E-X2D□	0	8	0	4.5	12
	M12	E2E-X3D□	0	12	0	8	18
	M18	E2E-X7D□	0	18	0	20	27
	M30	E2E-X10D□	0	30	0	40	45
Double distance model	M12	E2E-X4D□	0	18	0	12	18
	M18	E2E-X8D□	0	27	0	24	27
	M30	E2E-X15D□	0	45	0	45	45
Single distance model	M8	E2E-X1R5D□	0	8	0	4.5	12
	M12	E2E-X2R5D□	0	12	0	8	18
	M18	E2E-X5D□	0	18	0	20	27

### Unshielded

Type	Size	Model	L	d	D	m	n
Standard model	M8	E2E-X4MD□	9	24	9	8	24
	M12	E2E-X8MD□	11	40	11	20	40
	M18	E2E-X14MD□	18	55	18	40	54
	M30	E2E-X20MD□	25	90	25	70	90
Double distance model	M18	E2E-X16MD□	21	70	21	48	70
	M30	E2E-X30MD□	40	120	40	90	120

When the Proximity Sensor is mounted in metal, ensure that the minimum distances given in the following table are maintained.

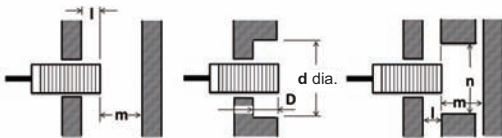

(Unit: mm)

### Shielded

Type	Size	Model	l	d	D	m	n
Standard model	M8	E2E-X2D□	0	8	0	4.5	12
	M12	E2E-X3D□	0	12	0	8	18
	M18	E2E-X7D□	0	18	0	20	27
	M30	E2E-X10D□	0	30	0	40	45
Double distance model	M12	E2E-X4D□	2.4	18	2.4	12	18
	M18	E2E-X8D□	3.6	27	3.6	24	27
	M30	E2E-X15D□	6	45	6	45	45
Single distance model	M8	E2E-X1R5D□	0	8	0	4.5	12
	M12	E2E-X2R5D□	0	12	0	8	18
	M18	E2E-X5D□	0	18	0	20	27

### Unshielded

Type	Size	Model	l	d	D	m	n
Standard model	M8	E2E-X4MD□	12	24	12	8	24
	M12	E2E-X8MD□	15	40	15	20	40
	M18	E2E-X14MD□	22	55	22	40	54
	M30	E2E-X20MD□	30	90	30	70	90
Double distance model	M18	E2E-X16MD□	25	70	25	48	70
	M30	E2E-X30MD□	45	120	45	90	120

## Mutual Interference

When installing two or more Proximity Sensors face-to-face or side-by-side, ensure that the minimum distances given in the following table are maintained.

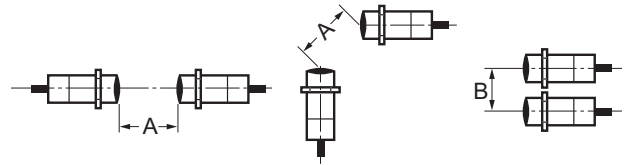

(Unit: mm)

### Shielded

Type	Size	Model	A	B
Standard model	M8	E2E-X2D□	20	15
	M12	E2E-X3D□	30(20)	20(12)
	M18	E2E-X7D□	50(30)	35(18)
	M30	E2E-X10D□	100(50)	70(35)
Double distance model	M12	E2E-X4D□	30	20
	M18	E2E-X8D□	60	35
	M30	E2E-X15D□	110	90
Single distance model	M8	E2E-X1R5D□	20	15
	M12	E2E-X2R5D□	30	20
	M18	E2E-X5D□	50	35

### Unshielded

Type	Size	Model	A	B
Standard model	M8	E2E-X4MD□	80	60
	M12	E2E-X8MD□	120(60)	100(50)
	M18	E2E-X14MD□	200(100)	110(60)
	M30	E2E-X20MD□	300(100)	200(100)
Double distance model	M18	E2E-X16MD□	200	120
	M30	E2E-X30MD□	350	300

- Note:**
1. Values in parentheses apply to Sensors operating at different frequencies.
  2. The values of mutual interference are provided for reference. Test the sensors on the actual machine or contact your OMRON sales representative to validate that there is no interference.

## Mounting

### Tightening Force

Do not tighten the sensor mounting nuts with excessive force. Secure the mounting nuts to the corresponding torque values in the following table.

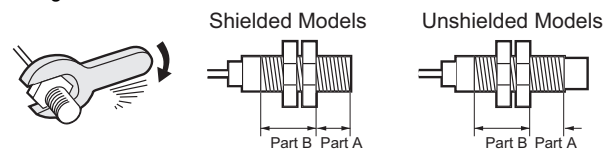

- Note:**
1. The allowable tightening strength depends on the distance from the edge of the head, as shown in the following table. (A is the distance from the edge of the head. B includes the nut on the head side. If the edge of the nut is in part A, the tightening torque for part A applies instead.)
  2. The following strengths assume washers are being used.

### Standard/Double distance model

Model	Part A		Part B Torque
	Dimension (mm)	Torque	
M8	Shielded	9	9 N·m
	Unshielded	3	
M12	---	---	30 N·m
M18	---	---	70 N·m
M30	---	---	180 N·m

### Single distance model

Model	Part A		Part B Torque
	Dimension (mm)	Torque	
M8	9	9 N·m	12 N·m
M12	---	---	30 N·m
M18	---	---	70 N·m

Dimensions

Sensor

DC 2-wire (Standard/Double distance model)

Pre-wired Models  
Pre-wired Connector Models  
(Shielded)



Note: Refer to the figure below the table for the connections of the Pre-wired Connector Model.

Pre-wired Models  
Pre-wired Connector Models  
(Unshielded)



Note: Refer to the figure below the table for the connections of the Pre-wired Connector Model.

E2E-X2D

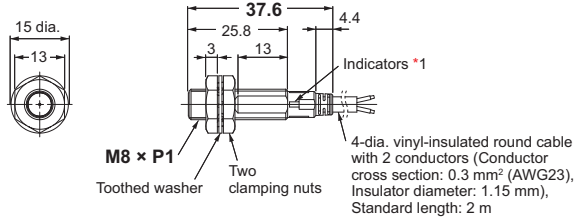

E2E-X4MD

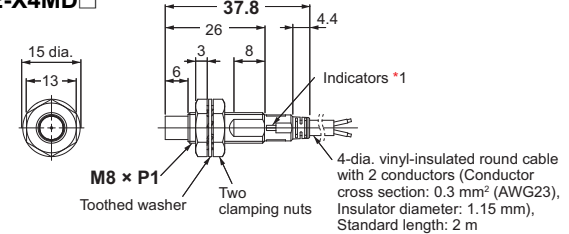

E2E-X3D

E2E-X4D

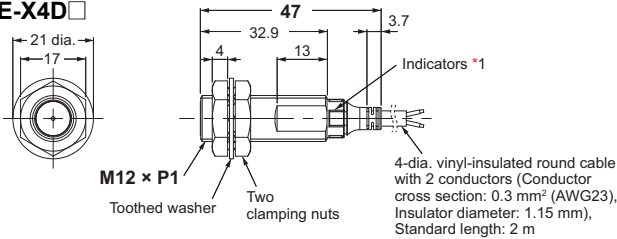

E2E-X8MD

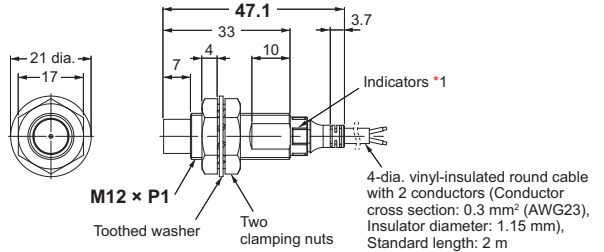

E2E-X7D

E2E-X8D

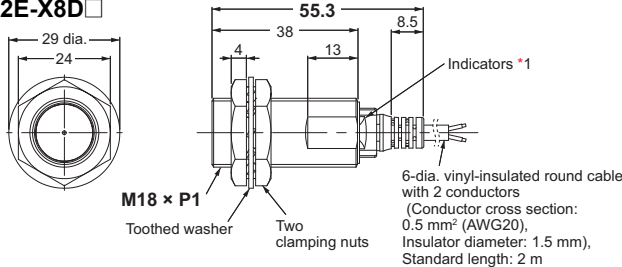

E2E-X14MD

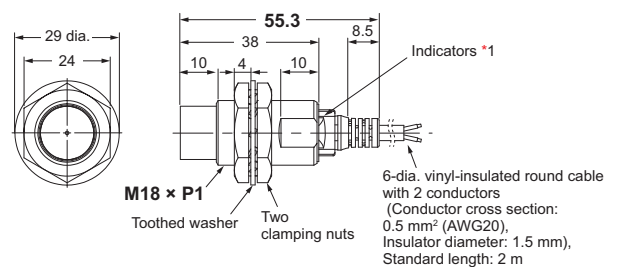

E2E-X10D

E2E-X15D

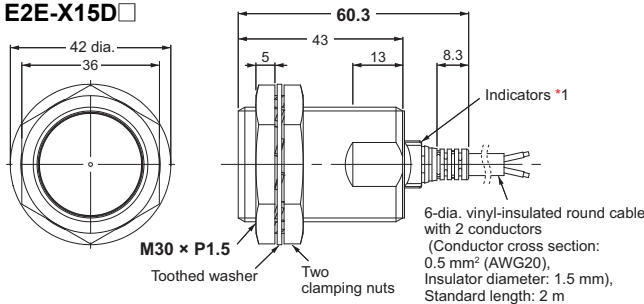

E2E-X20MD

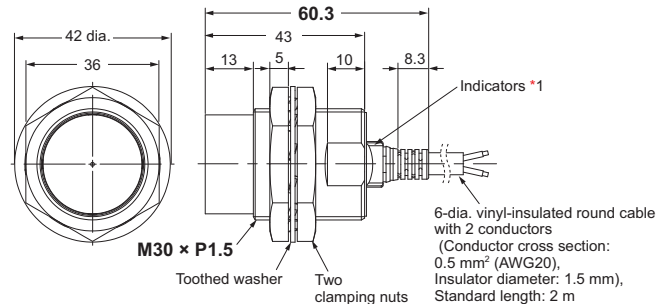

\*1. D1 Models: Operation indicator (Orange), Setting indicator (Green)/ D2 Models: Operation indicator (Orange)

Pre-wired Connector Models (-M1TGJ)

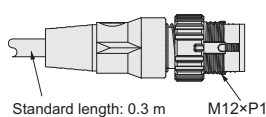

Note: Refer to the Pre-wired Model for the cable specifications of the Pre-wired Connector Model.

Mounting Hole Dimensions



Dimensions	F (mm)
M8	8.5 dia. <sup>+0.5</sup> / <sub>0</sub>
M12	12.5 dia. <sup>+0.5</sup> / <sub>0</sub>
M18	18.5 dia. <sup>+0.5</sup> / <sub>0</sub>
M30	30.5 dia. <sup>+0.5</sup> / <sub>0</sub>

Angle R of the Bending Wire

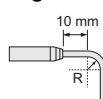

Dimensions	R (mm)
M8	12
M12	
M18	
M30	18

Wire pullout position



Dimensions	Sc (mm)
M8	-
M12	
M18	
M30	2.5

DC 2-wire Triple distance model

DC 2-wire Standard/Double/Single distance model

DC 3-wire

XS5 NEXT Series

XS5

XS3

# E2E NEXT Series

## Sensor

### DC 2-wire (Long-body Standard/Double distance model)

#### Pre-wired Models (Shielded)



#### Pre-wired Models (Unshielded)



#### E2E-X3D□L

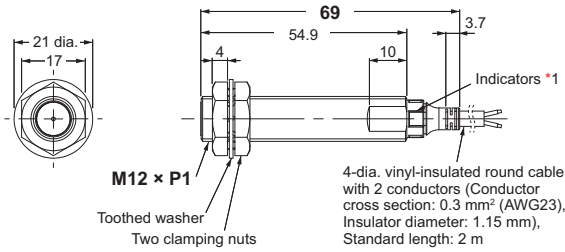

#### E2E-X8MD□L

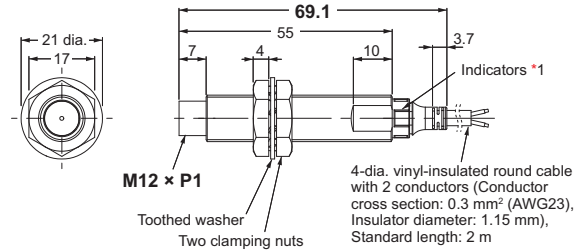

#### E2E-X7D□L

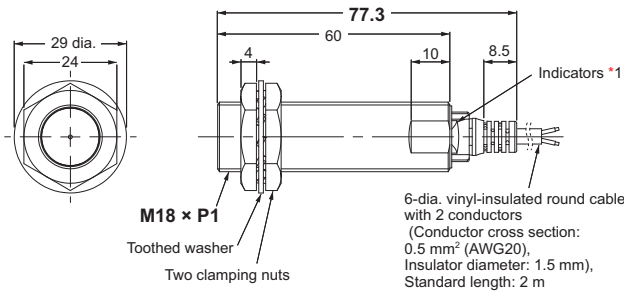

#### E2E-X14MD□L E2E-X16MD□L

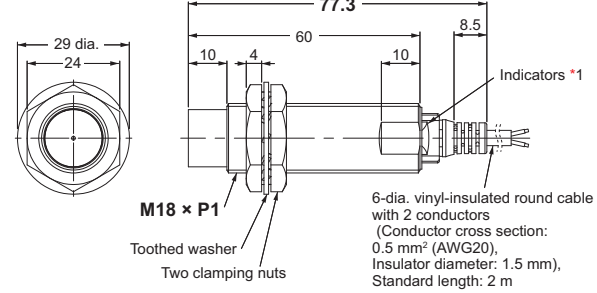

#### E2E-X10D□L

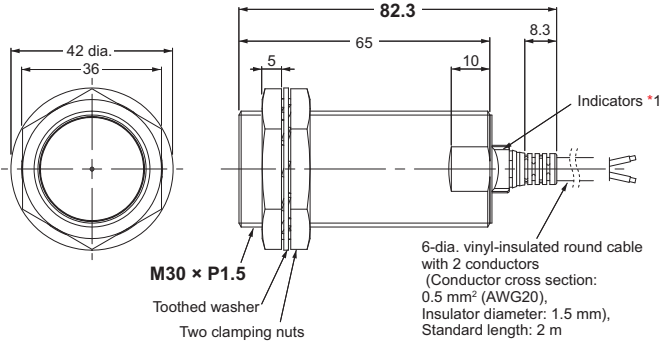

#### E2E-X20MD□L

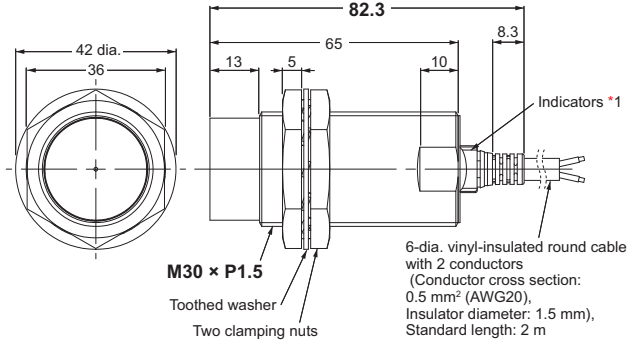

#### E2E-X30MD□L

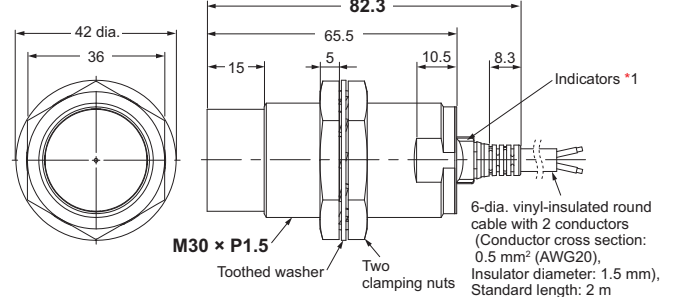

\*1. D1 Models: Operation indicator (Orange), Setting indicator (Green) / D2 Models: Operation indicator (Orange)

#### Mounting Hole Dimensions



Dimensions	F (mm)
M8	8.5 dia. <sup>+0.5</sup> / <sub>0</sub>
M12	12.5 dia. <sup>+0.5</sup> / <sub>0</sub>
M18	18.5 dia. <sup>+0.5</sup> / <sub>0</sub>
M30	30.5 dia. <sup>+0.5</sup> / <sub>0</sub>

#### Angle R of the Bending Wire

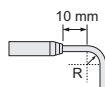

Dimensions	R (mm)
M8	12
M12	12
M18	18
M30	18

#### Wire pullout position



Dimensions	Sc (mm)
M8	- (0)
M12	- (0)
M18	2.5
M30	2.5

Sensor

DC 2-wire (Standard model)

M12 Connector Models (Shielded)



M12 Connector Models (Unshielded)



E2E-X2D□-M1/-M1G

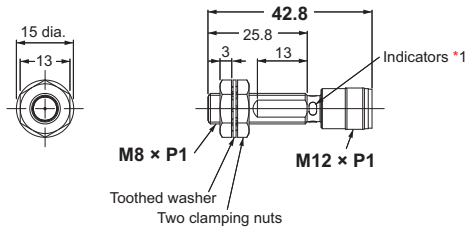

E2E-X4MD□-M1/-M1G

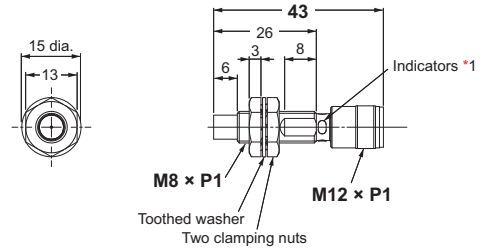

E2E-X3D□-M1/-M1G

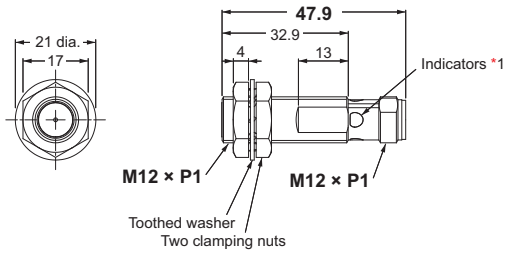

E2E-X8MD□-M1/-M1G

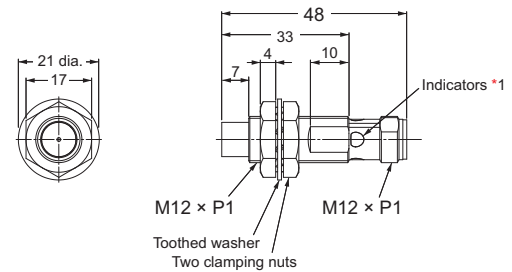

E2E-X7D□-M1/-M1G

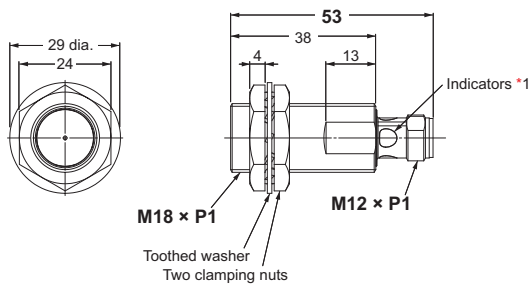

E2E-X14MD□-M1/-M1G

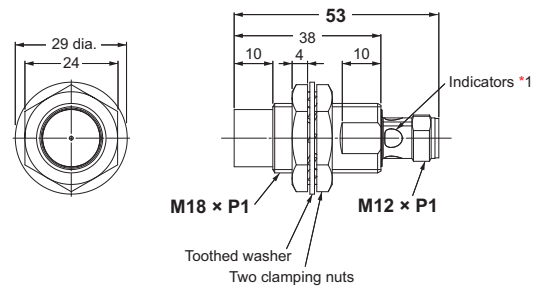

E2E-X10D□-M1/-M1G

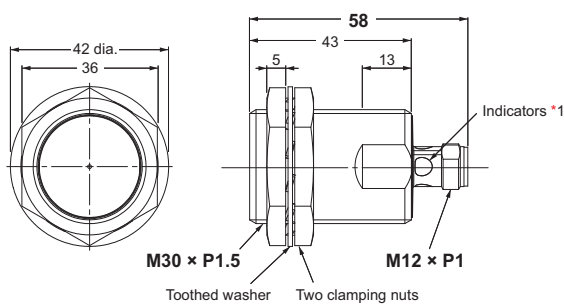

E2E-X20MD□-M1/-M1G

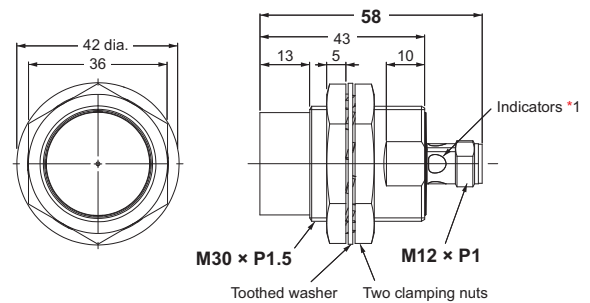

\*1. D1 Models: Operation indicator (Orange), Setting indicator (Green)/ D2 Models: Operation indicator (Orange)

Mounting Hole Dimensions



Dimensions	F (mm)
M8	8.5 dia. <sup>+0.5</sup> / <sub>0</sub>
M12	12.5 dia. <sup>+0.5</sup> / <sub>0</sub>
M18	18.5 dia. <sup>+0.5</sup> / <sub>0</sub>
M30	30.5 dia. <sup>+0.5</sup> / <sub>0</sub>

DC 2-wire Triple distance model

Standard/Double/Single distance model DC 2-wire

DC 3-wire

XS5 NEXT Series

XS5

XS3

# E2E NEXT Series

## Sensor

### DC 2-wire (Standard model)

#### M8 Connector Models (Shielded)



#### M8 Connector Models (Unshielded)



#### E2E-X2D□-M3G

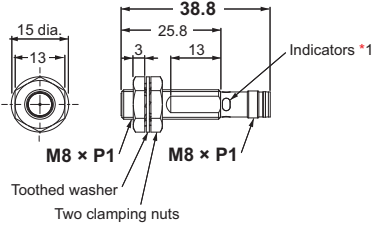

#### E2E-X4MD□-M3G

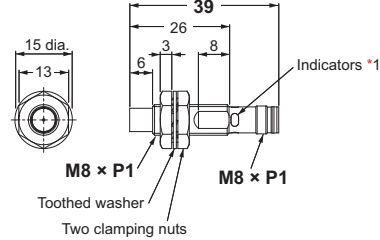

### DC 2-wire (Single distance model)

#### Pre-wired Models Pre-wired Connector Models (Shielded)



**Note: 1.**  
Refer to the figure below the table for the connections of the Pre-wired Connector Model.

#### E2E-X1R5D□

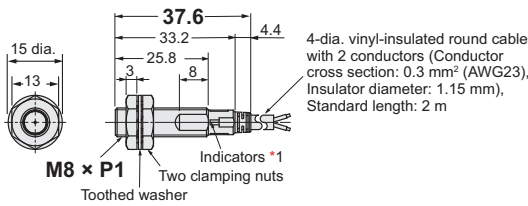

#### E2E-X2R5D□

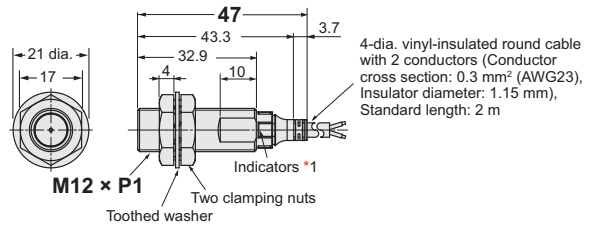

#### E2E-X5D□

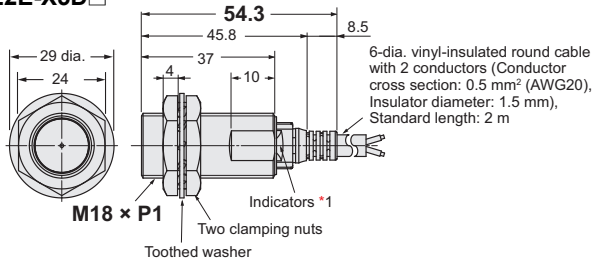

\*1. D1 Models: Operation indicator (Orange), Setting indicator (Green)/ D2 Models: Operation indicator (Orange)

#### Pre-wired Connector Models (-M1TGJ)

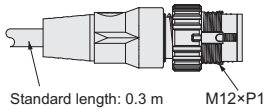

**Note:** Refer to the Pre-wired Model for the cable specifications of the Pre-wired Connector Model.

#### Mounting Hole Dimensions



Dimensions	F (mm)
M8	8.5 dia. $^{+0.5}_0$
M12	12.5 dia. $^{+0.5}_0$
M18	18.5 dia. $^{+0.5}_0$
M30	30.5 dia. $^{+0.5}_0$

#### Angle R of the Bending Wire

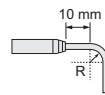

Dimensions	R (mm)
M8	12
M12	
M18	18
M30	

#### Wire pullout position



Dimensions	Sc (mm)
M8	- (0)
M12	
M18	2.5
M30	

## Enables easier and standardized designs previously not possible

- The world's longest sensing distance\*<sup>1</sup>  
Nearly double the sensing distance of previous
- With high-brightness LED, the indicator is visible anywhere from 360°.
- Only 10 Seconds\*<sup>2</sup> to Replace a Proximity Sensor with the "e-jig" (Mounting Sleeve).
- Cables with enhanced oil resistance enabled 2-year oil resistance\*<sup>3</sup>.
- IP69K compliant for water resistance and wash resistance
- Comes in a wide variation to make sensor selection easy
- UL certification (UL60947-5-2)\*<sup>4</sup> and  
CSA certification (CSA C22.2 UL60947-5-2-14)



For the most recent information on models that have been certified for safety standards, refer to your OMRON website.

\*1. Based on August 2022 OMRON investigation.

\*2. Time required to adjust the distance when installing a Sensor. Based on OMRON investigation.

\*3. Refer to *Ratings and Specifications* for details. However, E2E Connector Models is excluded.

\*4. M8 (4-pin) Connector Models are not UL certified.

Be sure to read *Safety Precautions* on page 72.

## Model Number Legend

E2E - X (1) (2) (3) (4) (5) (6) (7) (8) - (9) - (10) (11)

No.	Type	Code	Meaning
(1)	Sensing distance	Number	Sensing distance (Unit: mm) (R: Indication of decimal point)
(2)	Shielding	Blank	Shielded
		M	Unshielded
(3)	Output configuration	B	PNP open collector
		C	NPN open collector
(4)	Operation mode	1	Normally open (NO)
		2	Normally closed (NC)
		3	Normally open, Normally closed (NO+NC)
(5)	Oscillation frequency type	Blank	Standard frequency
		5	Different frequency
(6)	IO-Link baud rate	Blank	Non IO-Link compliant
		D	COM2 (38.4 kbps)
		T	COM3 (230.4 kbps)
(7)	Body size	Blank	Standard
		L	Long Body
(8)	Size	8	M8
		12	M12
		18	M18
		30	M30
(9)	Connection method	Blank	Pre-wired Models
		M1	M12 Connector Models
		M3	M8 (4-pin) Connector Models
		M5	M8 (3-pin) Connector Models
		M1TJ	M12 Pre-wired Smartclick Connector Models
		M1TJR	M12 Pre-wired Smartclick Connector Models Robot (bending-resistant) cable
(10)	Cable specifications (Only shown in the model number of Pre-wired Models.)	Blank	Standard PVC cable
		R	Robot (bending-resistant) cable
(11)	Cable length	Number M	Cable length

**Note:** The purpose of this model number legend is to provide understanding of the meaning of specifications from the model number.

Triple distance model

Standard/Double/Single distance model

DC 2-wire

DC 3-wire

XS5

XS5 NEXT Series

XS3

# E2E NEXT Series

## Ordering Information

### PREMIUM Model

DC 3-wire (Quadruple distance model) [Refer to *Dimensions* on page 75.]  
Shielded \*1

Size (Sensing distance)	Connection method	Body size	Operation mode	Model		
				PNP	NPN	
M8 (4 mm)	Pre-wired (2 m) *2	38 mm *3	NO	E2E-X4B1D8 2M	E2E-X4C18 2M	
			NC	E2E-X4B28 2M	E2E-X4C28 2M	
		48 mm	NO	E2E-X4B1DL8 2M	E2E-X4C1L8 2M	
			NC	E2E-X4B2L8 2M	E2E-X4C2L8 2M	
	M12 Pre-wired Smartclick Connector (0.3 m)	38 mm *4	NO	E2E-X4B1D8-M1TJ 0.3M	E2E-X4C18-M1TJ 0.3M	
			NC	E2E-X4B28-M1TJ 0.3M	E2E-X4C28-M1TJ 0.3M	
		48 mm	NO	E2E-X4B1DL8-M1TJ 0.3M	E2E-X4C1L8-M1TJ 0.3M	
			NC	E2E-X4B2L8-M1TJ 0.3M	E2E-X4C2L8-M1TJ 0.3M	
	M12 Connector	43 mm	NO	E2E-X4B1D8-M1	E2E-X4C18-M1	
			NC	E2E-X4B28-M1	E2E-X4C28-M1	
		53 mm	NO	E2E-X4B1DL8-M1	E2E-X4C1L8-M1	
			NC	E2E-X4B2L8-M1	E2E-X4C2L8-M1	
	M8 Connector (4-pin)	39 mm	NO	E2E-X4B1D8-M3	E2E-X4C18-M3	
			NC	E2E-X4B28-M3	E2E-X4C28-M3	
		49 mm	NO	E2E-X4B1DL8-M3	E2E-X4C1L8-M3	
			NC	E2E-X4B2L8-M3	E2E-X4C2L8-M3	
	M8 Connector (3-pin)	39 mm	NO	E2E-X4B1D8-M5	E2E-X4C18-M5	
			NC	E2E-X4B28-M5	E2E-X4C28-M5	
		49 mm	NO	E2E-X4B1DL8-M5	E2E-X4C1L8-M5	
			NC	E2E-X4B2L8-M5	E2E-X4C2L8-M5	
	M12 (9 mm)	Pre-wired (2 m) *2	47 mm *3	NO	E2E-X9B1D12 2M	E2E-X9C112 2M
				NC	E2E-X9B212 2M	E2E-X9C212 2M
			69 mm	NO	E2E-X9B1DL12 2M	E2E-X9C1L12 2M
				NC	E2E-X9B2L12 2M	E2E-X9C2L12 2M
M12 Pre-wired Smartclick Connector (0.3 m)		47 mm *4	NO	E2E-X9B1D12-M1TJ 0.3M	E2E-X9C112-M1TJ 0.3M	
			NC	E2E-X9B212-M1TJ 0.3M	E2E-X9C212-M1TJ 0.3M	
		69 mm	NO	E2E-X9B1DL12-M1TJ 0.3M	E2E-X9C1L12-M1TJ 0.3M	
			NC	E2E-X9B2L12-M1TJ 0.3M	E2E-X9C2L12-M1TJ 0.3M	
M12 Connector		48 mm	NO	E2E-X9B1D12-M1	E2E-X9C112-M1	
			NC	E2E-X9B212-M1	E2E-X9C212-M1	
		70 mm	NO	E2E-X9B1DL12-M1	E2E-X9C1L12-M1	
			NC	E2E-X9B2L12-M1	E2E-X9C2L12-M1	
M18 (14 mm)	Pre-wired (2 m) *2	55 mm *3	NO	E2E-X14B1D18 2M	E2E-X14C118 2M	
			NC	E2E-X14B218 2M	E2E-X14C218 2M	
		77 mm	NO	E2E-X14B1DL18 2M	E2E-X14C1L18 2M	
			NC	E2E-X14B2L18 2M	E2E-X14C2L18 2M	
	M12 Pre-wired Smartclick Connector (0.3 m)	55 mm *4	NO	E2E-X14B1D18-M1TJ 0.3M	E2E-X14C118-M1TJ 0.3M	
			NC	E2E-X14B218-M1TJ 0.3M	E2E-X14C218-M1TJ 0.3M	
		77 mm	NO	E2E-X14B1DL18-M1TJ 0.3M	E2E-X14C1L18-M1TJ 0.3M	
			NC	E2E-X14B2L18-M1TJ 0.3M	E2E-X14C2L18-M1TJ 0.3M	
	M12 Connector	53 mm	NO	E2E-X14B1D18-M1	E2E-X14C118-M1	
			NC	E2E-X14B218-M1	E2E-X14C218-M1	
		75 mm	NO	E2E-X14B1DL18-M1	E2E-X14C1L18-M1	
			NC	E2E-X14B2L18-M1	E2E-X14C2L18-M1	



PREMIUM Model

Size (Sensing distance)	Connection method	Body size	Operation mode	Model	
				PNP	NPN
M30 (23 mm)	Pre-wired (2 m) *2	60 mm *4	NO	E2E-X23B1D30 2M	E2E-X23C130 2M
			NC	E2E-X23B230 2M	E2E-X23C230 2M
		82 mm	NO	E2E-X23B1DL30 2M	E2E-X23C1L30 2M
			NC	E2E-X23B2L30 2M	E2E-X23C2L30 2M
	M12 Pre-wired Smartclick Connector (0.3 m)	60 mm *4	NO	E2E-X23B1D30-M1TJ 0.3M	E2E-X23C130-M1TJ 0.3M
			NC	E2E-X23B230-M1TJ 0.3M	E2E-X23C230-M1TJ 0.3M
		82 mm	NO	E2E-X23B1DL30-M1TJ 0.3M	E2E-X23C1L30-M1TJ 0.3M
			NC	E2E-X23B2L30-M1TJ 0.3M	E2E-X23C2L30-M1TJ 0.3M
	M12 Connector	58 mm	NO	E2E-X23B1D30-M1	E2E-X23C130-M1
			NC	E2E-X23B230-M1	E2E-X23C230-M1
		80 mm	NO	E2E-X23B1DL30-M1	E2E-X23C1L30-M1
			NC	E2E-X23B2L30-M1	E2E-X23C2L30-M1

\*1. When embedding the Proximity Sensor in metal, refer to *Influence of Surrounding Metal* on page 73.

\*2. Models with 5-m cable length are also available with "5M" suffix. (Example: E2E-X9B1D12 5M)

\*3. Models with 2-m and 5-m robot (bending-resistant) cables are also available with "-R" in the model number. (Example: E2E-X9B1D12-R 2M/ E2E-X9B1D12-R 5M)

\*4. Models with M12 Smartclick connector model robot (bending-resistant) cables are also available with "R" in the model number. (Example: E2E-X9B1D12-M1TJR 0.3M)

**Note:** 1. Models in    are equipped with IO-Link (COM2). For IO-Link (COM3), select a model number with the format of "E2E-X        T". (Example: E2E-X9B1T12 2M).

Operation mode NO can be changed to NC via IO-Link communications.

2. IO-Link is not supported for NC-type PNP outputs or all types of NPN outputs.

# E2E NEXT Series

## PREMIUM Model

DC 3-wire (Quadruple distance model) [Refer to *Dimensions* on page 76.]

Unshielded

Size (Sensing distance)	Connection method	Body size	Operation mode	Model		
				PNP	NPN	
M8 (8 mm)	Pre-wired (2 m) *1	38 mm *2	NO	E2E-X8MB1D8 2M	E2E-X8MC18 2M	
			NC	E2E-X8MB28 2M	E2E-X8MC28 2M	
		48 mm	NO	E2E-X8MB1DL8 2M	E2E-X8MC1L8 2M	
			NC	E2E-X8MB2L8 2M	E2E-X8MC2L8 2M	
	M12 Pre-wired Smartclick Connector (0.3 m)	38 mm *3	NO	E2E-X8MB1D8-M1TJ 0.3M	E2E-X8MC18-M1TJ 0.3M	
			NC	E2E-X8MB28-M1TJ 0.3M	E2E-X8MC28-M1TJ 0.3M	
		48 mm	NO	E2E-X8MB1DL8-M1TJ 0.3M	E2E-X8MC1L8-M1TJ 0.3M	
			NC	E2E-X8MB2L8-M1TJ 0.3M	E2E-X8MC2L8-M1TJ 0.3M	
	M12 Connector	43 mm	NO	E2E-X8MB1D8-M1	E2E-X8MC18-M1	
			NC	E2E-X8MB28-M1	E2E-X8MC28-M1	
		53 mm	NO	E2E-X8MB1DL8-M1	E2E-X8MC1L8-M1	
			NC	E2E-X8MB2L8-M1	E2E-X8MC2L8-M1	
	M8 Connector (4-pin)	39 mm	NO	E2E-X8MB1D8-M3	E2E-X8MC18-M3	
			NC	E2E-X8MB28-M3	E2E-X8MC28-M3	
		49 mm	NO	E2E-X8MB1DL8-M3	E2E-X8MC1L8-M3	
			NC	E2E-X8MB2L8-M3	E2E-X8MC2L8-M3	
	M8 Connector (3-pin)	39 mm	NO	E2E-X8MB1D8-M5	E2E-X8MC18-M5	
			NC	E2E-X8MB28-M5	E2E-X8MC28-M5	
		49 mm	NO	E2E-X8MB1DL8-M5	E2E-X8MC1L8-M5	
			NC	E2E-X8MB2L8-M5	E2E-X8MC2L8-M5	
	M12 (16 mm)	Pre-wired (2 m) *1	47 mm *2	NO	E2E-X16MB1D12 2M	E2E-X16MC112 2M
				NC	E2E-X16MB212 2M	E2E-X16MC212 2M
			69 mm	NO	E2E-X16MB1DL12 2M	E2E-X16MC1L12 2M
				NC	E2E-X16MB2L12 2M	E2E-X16MC2L12 2M
M12 Pre-wired Smartclick Connector (0.3 m)		47 mm *3	NO	E2E-X16MB1D12-M1TJ 0.3M	E2E-X16MC112-M1TJ 0.3M	
			NC	E2E-X16MB212-M1TJ 0.3M	E2E-X16MC212-M1TJ 0.3M	
		69 mm	NO	E2E-X16MB1DL12-M1TJ 0.3M	E2E-X16MC1L12-M1TJ 0.3M	
			NC	E2E-X16MB2L12-M1TJ 0.3M	E2E-X16MC2L12-M1TJ 0.3M	
M12 Connector		48 mm	NO	E2E-X16MB1D12-M1	E2E-X16MC112-M1	
			NC	E2E-X16MB212-M1	E2E-X16MC212-M1	
		70 mm	NO	E2E-X16MB1DL12-M1	E2E-X16MC1L12-M1	
			NC	E2E-X16MB2L12-M1	E2E-X16MC2L12-M1	
M18 (30 mm)	Pre-wired (2 m) *1	77 mm *2	NO	E2E-X30MB1DL18 2M	E2E-X30MC1L18 2M	
			NC	E2E-X30MB2L18 2M	E2E-X30MC2L18 2M	
	M12 Pre-wired Smartclick Connector (0.3 m)	77 mm *3	NO	E2E-X30MB1DL18-M1TJ 0.3M	E2E-X30MC1L18-M1TJ 0.3M	
			NC	E2E-X30MB2L18-M1TJ 0.3M	E2E-X30MC2L18-M1TJ 0.3M	
	M12 Connector	75 mm	NO	E2E-X30MB1DL18-M1	E2E-X30MC1L18-M1	
			NC	E2E-X30MB2L18-M1	E2E-X30MC2L18-M1	
M30 (50 mm)	Pre-wired (2 m) *1	97 mm *2	NO	E2E-X50MB1DL30 2M	E2E-X50MC1L30 2M	
			NC	E2E-X50MB2L30 2M	E2E-X50MC2L30 2M	
	M12 Pre-wired Smartclick Connector (0.3 m)	97 mm *3	NO	E2E-X50MB1DL30-M1TJ 0.3M	E2E-X50MC1L30-M1TJ 0.3M	
			NC	E2E-X50MB2L30-M1TJ 0.3M	E2E-X50MC2L30-M1TJ 0.3M	
	M12 Connector	95 mm	NO	E2E-X50MB1DL30-M1	E2E-X50MC1L30-M1	
			NC	E2E-X50MB2L30-M1	E2E-X50MC2L30-M1	

\*1. Models with 5-m cable length are also available (Example: E2E-X16MB1D12 5M)

\*2. Models with 2-m and 5-m robot (bending-resistant) cables are also available with "-R" in the model number. (Example: E2E-X16MB1D12-R 2M/E2E-X16MB1D12-R 5M)

\*3. Models with M12 Smartclick connector model robot (bending-resistant) cables are also available with "R" in the model number. (Example: E2E-X16MB1D12-M1TJR 0.3M)

**Note:** 1. Models in   are equipped with IO-Link (COM2). For IO-Link (COM3), select a model number with the format of "E2E-X□□□□□" (Example: E2E-X16MB1T12 2M).

Operation mode NO can be changed to NC via IO-Link communications.

2. IO-Link is not supported for NC-type PNP outputs or all types of NPN outputs.

**PREMIUM Model**

**DC 3-wire (Triple distance model) [Refer to Dimensions on page 75.]  
Shielded \*1**

Size (Sensing distance)	Connection method	Body size	Operation mode	Model		
				PNP	NPN	
M8 (3 mm)	Pre-wired (2 m) *2	38 mm *3	NO	E2E-X3B1D8 2M	E2E-X3C18 2M	
			NC	E2E-X3B28 2M	E2E-X3C28 2M	
		48 mm	NO	E2E-X3B1DL8 2M	E2E-X3C1L8 2M	
			NC	E2E-X3B2L8 2M	E2E-X3C2L8 2M	
	M12 Pre-wired Smartclick Connector (0.3 m)	38 mm *4	NO	E2E-X3B1D8-M1TJ 0.3M	E2E-X3C18-M1TJ 0.3M	
			NC	E2E-X3B28-M1TJ 0.3M	E2E-X3C28-M1TJ 0.3M	
		48 mm	NO	E2E-X3B1DL8-M1TJ 0.3M	E2E-X3C1L8-M1TJ 0.3M	
			NC	E2E-X3B2L8-M1TJ 0.3M	E2E-X3C2L8-M1TJ 0.3M	
	M12 Connector	43 mm	NO	E2E-X3B1D8-M1	E2E-X3C18-M1	
			NC	E2E-X3B28-M1	E2E-X3C28-M1	
		53 mm	NO	E2E-X3B1DL8-M1	E2E-X3C1L8-M1	
			NC	E2E-X3B2L8-M1	E2E-X3C2L8-M1	
	M8 Connector (4-pin)	39 mm	NO	E2E-X3B1D8-M3	E2E-X3C18-M3	
			NC	E2E-X3B28-M3	E2E-X3C28-M3	
		49 mm	NO	E2E-X3B1DL8-M3	E2E-X3C1L8-M3	
			NC	E2E-X3B2L8-M3	E2E-X3C2L8-M3	
	M8 Connector (3-pin)	39 mm	NO	E2E-X3B1D8-M5	E2E-X3C18-M5	
			NC	E2E-X3B28-M5	E2E-X3C28-M5	
		49 mm	NO	E2E-X3B1DL8-M5	E2E-X3C1L8-M5	
			NC	E2E-X3B2L8-M5	E2E-X3C2L8-M5	
	M12 (6 mm)	Pre-wired (2 m) *2	47 mm *3	NO	E2E-X6B1D12 2M	E2E-X6C112 2M
				NC	E2E-X6B212 2M	E2E-X6C212 2M
				NO+NC	E2E-X6B3D12 2M	E2E-X6C312 2M
			69 mm	NO	E2E-X6B1DL12 2M	E2E-X6C1L12 2M
NC				E2E-X6B2L12 2M	E2E-X6C2L12 2M	
NO+NC				E2E-X6B3DL12 2M	E2E-X6C3L12 2M	
M12 Pre-wired Smartclick Connector (0.3 m)		47 mm *4	NO	E2E-X6B1D12-M1TJ 0.3M	E2E-X6C112-M1TJ 0.3M	
			NC	E2E-X6B212-M1TJ 0.3M	E2E-X6C212-M1TJ 0.3M	
			NO+NC	E2E-X6B3D12-M1TJ 0.3M	E2E-X6C312-M1TJ 0.3M	
		69 mm	NO	E2E-X6B1DL12-M1TJ 0.3M	E2E-X6C1L12-M1TJ 0.3M	
			NC	E2E-X6B2L12-M1TJ 0.3M	E2E-X6C2L12-M1TJ 0.3M	
			NO+NC	E2E-X6B3DL12-M1TJ 0.3M	E2E-X6C3L12-M1TJ 0.3M	
M12 Connector		48 mm	NO	E2E-X6B1D12-M1	E2E-X6C112-M1	
			NC	E2E-X6B212-M1	E2E-X6C212-M1	
			NO+NC	E2E-X6B3D12-M1	E2E-X6C312-M1	
		70 mm	NO	E2E-X6B1DL12-M1	E2E-X6C1L12-M1	
			NC	E2E-X6B2L12-M1	E2E-X6C2L12-M1	
			NO+NC	E2E-X6B3DL12-M1	E2E-X6C3L12-M1	

# E2E NEXT Series

## PREMIUM Model

Size (Sensing distance)	Connection method	Body size	Operation mode	Model	
				PNP	NPN
M18 (12 mm)	Pre-wired (2 m) *2	55 mm *3	NO	E2E-X12B1D18 2M	E2E-X12C118 2M
			NC	E2E-X12B218 2M	E2E-X12C218 2M
			NO+NC	E2E-X12B3D18 2M	E2E-X12C318 2M
		77 mm	NO	E2E-X12B1DL18 2M	E2E-X12C1L18 2M
			NC	E2E-X12B2L18 2M	E2E-X12C2L18 2M
			NO+NC	E2E-X12B3DL18 2M	E2E-X12C3L18 2M
	M12 Pre-wired Smartclick Connector (0.3 m)	55 mm *4	NO	E2E-X12B1D18-M1TJ 0.3M	E2E-X12C118-M1TJ 0.3M
			NC	E2E-X12B218-M1TJ 0.3M	E2E-X12C218-M1TJ 0.3M
			NO+NC	E2E-X12B3D18-M1TJ 0.3M	E2E-X12C318-M1TJ 0.3M
		77 mm	NO	E2E-X12B1DL18-M1TJ 0.3M	E2E-X12C1L18-M1TJ 0.3M
			NC	E2E-X12B2L18-M1TJ 0.3M	E2E-X12C2L18-M1TJ 0.3M
			NO+NC	E2E-X12B3DL18-M1TJ 0.3M	E2E-X12C3L18-M1TJ 0.3M
	M12 Connector	53 mm	NO	E2E-X12B1D18-M1	E2E-X12C118-M1
			NC	E2E-X12B218-M1	E2E-X12C218-M1
			NO+NC	E2E-X12B3D18-M1	E2E-X12C318-M1
		75 mm	NO	E2E-X12B1DL18-M1	E2E-X12C1L18-M1
			NC	E2E-X12B2L18-M1	E2E-X12C2L18-M1
			NO+NC	E2E-X12B3DL18-M1	E2E-X12C3L18-M1
M30 (22 mm)	Pre-wired (2 m) *2	60 mm *3	NO	E2E-X22B1D30 2M	E2E-X22C130 2M
			NC	E2E-X22B230 2M	E2E-X22C230 2M
			NO+NC	E2E-X22B3D30 2M	E2E-X22C330 2M
		82 mm	NO	E2E-X22B1DL30 2M	E2E-X22C1L30 2M
			NC	E2E-X22B2L30 2M	E2E-X22C2L30 2M
			NO+NC	E2E-X22B3DL30 2M	E2E-X22C3L30 2M
	M12 Pre-wired Smartclick Connector (0.3 m)	60 mm *4	NO	E2E-X22B1D30-M1TJ 0.3M	E2E-X22C130-M1TJ 0.3M
			NC	E2E-X22B230-M1TJ 0.3M	E2E-X22C230-M1TJ 0.3M
			NO+NC	E2E-X22B3D30-M1TJ 0.3M	E2E-X22C330-M1TJ 0.3M
		82 mm	NO	E2E-X22B1DL30-M1TJ 0.3M	E2E-X22C1L30-M1TJ 0.3M
			NC	E2E-X22B2L30-M1TJ 0.3M	E2E-X22C2L30-M1TJ 0.3M
			NO+NC	E2E-X22B3DL30-M1TJ 0.3M	E2E-X22C3L30-M1TJ 0.3M
	M12 Connector	58 mm	NO	E2E-X22B1D30-M1	E2E-X22C130-M1
			NC	E2E-X22B230-M1	E2E-X22C230-M1
			NO+NC	E2E-X22B3D30-M1	E2E-X22C330-M1
		80 mm	NO	E2E-X22B1DL30-M1	E2E-X22C1L30-M1
			NC	E2E-X22B2L30-M1	E2E-X22C2L30-M1
			NO+NC	E2E-X22B3DL30-M1	E2E-X22C3L30-M1

\*1. When embedding the Proximity Sensor in metal, refer to *Influence of Surrounding Metal* on page 73.

\*2. Models with 5-m cable length are also available (Example: E2E-X6B1D12 5M)

\*3. Models with 2-m and 5-m robot (bending-resistant) cables are also available with "-R" in the model number. (Example: E2E-X6B1D12-R 2M/ E2E-X6B1D12-R 5M)

\*4. Models with M12 Smartclick connector model robot (bending-resistant) cables are also available with "R" in the model number. (Example: E2E-X6B1D12-M1TJR 0.3M)

**Note:** 1. Models in   are equipped with IO-Link (COM2). For IO-Link (COM3), select a model number with the format of "E2E-X□□□□T□" (Example: E2E-X6B1T12 2M).

Operation mode NO can be changed to NC via IO-Link communications.

2. IO-Link is not supported for NC-type PNP outputs or all types of NPN outputs.

PREMIUM Model

DC 3-wire (Triple distance model) [Refer to Dimensions on page 76.]  
Unshielded

Size (Sensing distance)	Connection method	Body size	Operation mode	Model		
				PNP	NPN	
M8 (6 mm)	Pre-wired (2 m) *1	38 mm *2	NO	E2E-X6MB1D8 2M	E2E-X6MC18 2M	
			NC	E2E-X6MB28 2M	E2E-X6MC28 2M	
		48 mm	NO	E2E-X6MB1DL8 2M	E2E-X6MC1L8 2M	
			NC	E2E-X6MB2L8 2M	E2E-X6MC2L8 2M	
		M12 Pre-wired Smartclick Connector (0.3 m)	38 mm *3	NO	E2E-X6MB1D8-M1TJ 0.3M	E2E-X6MC18-M1TJ 0.3M
				NC	E2E-X6MB28-M1TJ 0.3M	E2E-X6MC28-M1TJ 0.3M
	48 mm		NO	E2E-X6MB1DL8-M1TJ 0.3M	E2E-X6MC1L8-M1TJ 0.3M	
			NC	E2E-X6MB2L8-M1TJ 0.3M	E2E-X6MC2L8-M1TJ 0.3M	
	M12 Connector		43 mm	NO	E2E-X6MB1D8-M1	E2E-X6MC18-M1
				NC	E2E-X6MB28-M1	E2E-X6MC28-M1
		53 mm	NO	E2E-X6MB1DL8-M1	E2E-X6MC1L8-M1	
			NC	E2E-X6MB2L8-M1	E2E-X6MC2L8-M1	
	M8 Connector (4-pin)	39 mm	NO	E2E-X6MB1D8-M3	E2E-X6MC18-M3	
			NC	E2E-X6MB28-M3	E2E-X6MC28-M3	
		49 mm	NO	E2E-X6MB1DL8-M3	E2E-X6MC1L8-M3	
			NC	E2E-X6MB2L8-M3	E2E-X6MC2L8-M3	
	M8 Connector (3-pin)	39 mm	NO	E2E-X6MB1D8-M5	E2E-X6MC18-M5	
			NC	E2E-X6MB28-M5	E2E-X6MC28-M5	
		49 mm	NO	E2E-X6MB1DL8-M5	E2E-X6MC1L8-M5	
			NC	E2E-X6MB2L8-M5	E2E-X6MC2L8-M5	
	M12 (10 mm)	Pre-wired (2 m) *1	47 mm *2	NO	E2E-X10MB1D12 2M	E2E-X10MC112 2M
				NC	E2E-X10MB212 2M	E2E-X10MC212 2M
				NO+NC	E2E-X10MB3D12 2M	E2E-X10MC312 2M
			69 mm	NO	E2E-X10MB1DL12 2M	E2E-X10MC1L12 2M
NC				E2E-X10MB2L12 2M	E2E-X10MC2L12 2M	
NO+NC				E2E-X10MB3DL12 2M	E2E-X10MC3L12 2M	
M12 Pre-wired Smartclick Connector (0.3 m)			47 mm *3	NO	E2E-X10MB1D12-M1TJ 0.3M	E2E-X10MC112-M1TJ 0.3M
				NC	E2E-X10MB212-M1TJ 0.3M	E2E-X10MC212-M1TJ 0.3M
				NO+NC	E2E-X10MB3D12-M1TJ 0.3M	E2E-X10MC312-M1TJ 0.3M
			69 mm	NO	E2E-X10MB1DL12-M1TJ 0.3M	E2E-X10MC1L12-M1TJ 0.3M
				NC	E2E-X10MB2L12-M1TJ 0.3M	E2E-X10MC2L12-M1TJ 0.3M
				NO+NC	E2E-X10MB3DL12-M1TJ 0.3M	E2E-X10MC3L12-M1TJ 0.3M
M12 Connector		48 mm	NO	E2E-X10MB1D12-M1	E2E-X10MC112-M1	
			NC	E2E-X10MB212-M1	E2E-X10MC212-M1	
			NO+NC	E2E-X10MB3D12-M1	E2E-X10MC312-M1	
		70 mm	NO	E2E-X10MB1DL12-M1	E2E-X10MC1L12-M1	
			NC	E2E-X10MB2L12-M1	E2E-X10MC2L12-M1	
			NO+NC	E2E-X10MB3DL12-M1	E2E-X10MC3L12-M1	
M18 (20 mm)		Pre-wired (2 m) *1	77 mm *2	NO	E2E-X20MB1DL18 2M	E2E-X20MC1L18 2M
				NC	E2E-X20MB2L18 2M	E2E-X20MC2L18 2M
				NO+NC	E2E-X20MB3DL18 2M	E2E-X20MC3L18 2M
			77 mm *3	NO	E2E-X20MB1DL18-M1TJ 0.3M	E2E-X20MC1L18-M1TJ 0.3M
				NC	E2E-X20MB2L18-M1TJ 0.3M	E2E-X20MC2L18-M1TJ 0.3M
				NO+NC	E2E-X20MB3DL18-M1TJ 0.3M	E2E-X20MC3L18-M1TJ 0.3M
	M12 Connector	75 mm	NO	E2E-X20MB1DL18-M1	E2E-X20MC1L18-M1	
			NC	E2E-X20MB2L18-M1	E2E-X20MC2L18-M1	
			NO+NC	E2E-X20MB3DL18-M1	E2E-X20MC3L18-M1	

# E2E NEXT Series

## PREMIUM Model

Size (Sensing distance)	Connection method	Body size	Operation mode	Model	
				PNP	NPN
M30 (40 mm)	Pre-wired (2 m) *1	82 mm *2	NO	E2E-X40MB1DL30 2M	E2E-X40MC1L30 2M
			NC	E2E-X40MB2L30 2M	E2E-X40MC2L30 2M
			NO+NC	E2E-X40MB3DL30 2M	E2E-X40MC3L30 2M
	M12 Pre-wired Smartclick Connector (0.3 m)	82 mm *3	NO	E2E-X40MB1DL30-M1TJ 0.3M	E2E-X40MC1L30-M1TJ 0.3M
			NC	E2E-X40MB2L30-M1TJ 0.3M	E2E-X40MC2L30-M1TJ 0.3M
			NO+NC	E2E-X40MB3DL30-M1TJ 0.3M	E2E-X40MC3L30-M1TJ 0.3M
	M12 Connector	80 mm	NO	E2E-X40MB1DL30-M1	E2E-X40MC1L30-M1
			NC	E2E-X40MB2L30-M1	E2E-X40MC2L30-M1
			NO+NC	E2E-X40MB3DL30-M1	E2E-X40MC3L30-M1

\*1. Models with 5-m cable length are also available (Example: E2E-X10MB1D12 5M)

\*2. Models with 2-m and 5-m robot (bending-resistant) cables are also available with "-R" in the model number. (Example: E2E-X10MB1D12-R 2M/E2E-X10MB1D12-R 5M)

\*3. Models with M12 Smartclick connector model robot (bending-resistant) cables are also available with R" in the model number. (Example: E2E-X10MB1D12-M1TJR 0.3M)

**Note:** 1. Models in   are equipped with IO-Link (COM2). For IO-Link (COM3), select a model number with the format of "E2E-X      " (Example: E2E-X10MB1T12 2M).

Operation mode NO can be changed to NC via IO-Link communications.

2. IO-Link is not supported for NC-type PNP outputs or all types of NPN outputs.

BASIC Model

DC 3-wire (Double distance model) [Refer to Dimensions on page 79.]  
Shielded

Size (Sensing distance)	Connection method	Body size	Operation mode	Model		
				PNP	NPN	
M8 (2 mm)	Pre-wired (2 m) *1	38 mm *2	NO	E2E-X2B1D8 2M	E2E-X2C18 2M	
			NC	E2E-X2B28 2M	E2E-X2C28 2M	
		48 mm	NO	E2E-X2B1DL8 2M	E2E-X2C1L8 2M	
			NC	E2E-X2B2L8 2M	E2E-X2C2L8 2M	
	M12 Pre-wired Smartclick Connector (0.3 m)	38 mm *3	NO	E2E-X2B1D8-M1TJ 0.3M	E2E-X2C18-M1TJ 0.3M	
			NC	E2E-X2B28-M1TJ 0.3M	E2E-X2C28-M1TJ 0.3M	
		48 mm	NO	E2E-X2B1DL8-M1TJ 0.3M	E2E-X2C1L8-M1TJ 0.3M	
			NC	E2E-X2B2L8-M1TJ 0.3M	E2E-X2C2L8-M1TJ 0.3M	
	M12 Connector	43 mm	NO	E2E-X2B1D8-M1	E2E-X2C18-M1	
			NC	E2E-X2B28-M1	E2E-X2C28-M1	
		53 mm	NO	E2E-X2B1DL8-M1	E2E-X2C1L8-M1	
			NC	E2E-X2B2L8-M1	E2E-X2C2L8-M1	
	M8 Connector (4-pin)	39 mm	NO	E2E-X2B1D8-M3	E2E-X2C18-M3	
			NC	E2E-X2B28-M3	E2E-X2C28-M3	
		49 mm	NO	E2E-X2B1DL8-M3	E2E-X2C1L8-M3	
			NC	E2E-X2B2L8-M3	E2E-X2C2L8-M3	
	M8 Connector (3-pin)	39 mm	NO	E2E-X2B1D8-M5	E2E-X2C18-M5	
			NC	E2E-X2B28-M5	E2E-X2C28-M5	
		49 mm	NO	E2E-X2B1DL8-M5	E2E-X2C1L8-M5	
			NC	E2E-X2B2L8-M5	E2E-X2C2L8-M5	
	M12 (4 mm)	Pre-wired (2 m) *1	47 mm *2	NO	E2E-X4B1D12 2M	E2E-X4C112 2M
				NC	E2E-X4B212 2M	E2E-X4C212 2M
				NO+NC	E2E-X4B3D12 2M	E2E-X4C312 2M
			69 mm	NO	E2E-X4B1DL12 2M	E2E-X4C1L12 2M
NC				E2E-X4B2L12 2M	E2E-X4C2L12 2M	
NO+NC				E2E-X4B3DL12 2M	E2E-X4C3L12 2M	
M12 Pre-wired Smartclick Connector (0.3 m)		47 mm *3	NO	E2E-X4B1D12-M1TJ 0.3M	E2E-X4C112-M1TJ 0.3M	
			NC	E2E-X4B212-M1TJ 0.3M	E2E-X4C212-M1TJ 0.3M	
			NO+NC	E2E-X4B3D12-M1TJ 0.3M	E2E-X4C312-M1TJ 0.3M	
		69 mm	NO	E2E-X4B1DL12-M1TJ 0.3M	E2E-X4C1L12-M1TJ 0.3M	
			NC	E2E-X4B2L12-M1TJ 0.3M	E2E-X4C2L12-M1TJ 0.3M	
			NO+NC	E2E-X4B3DL12-M1TJ 0.3M	E2E-X4C3L12-M1TJ 0.3M	
M12 Connector		48 mm	NO	E2E-X4B1D12-M1	E2E-X4C112-M1	
			NC	E2E-X4B212-M1	E2E-X4C212-M1	
			NO+NC	E2E-X4B3D12-M1	E2E-X4C312-M1	
		70 mm	NO	E2E-X4B1DL12-M1	E2E-X4C1L12-M1	
			NC	E2E-X4B2L12-M1	E2E-X4C2L12-M1	
			NO+NC	E2E-X4B3DL12-M1	E2E-X4C3L12-M1	

Triple distance model

Standard/Double/Single distance model

DC 2-wire

DC 3-wire

DC 2-wire

DC 3-wire

DC 2-wire

# E2E NEXT Series

## BASIC Model

Size (Sensing distance)	Connection method	Body size	Operation mode	Model	
				PNP	NPN
M18 (8 mm)	Pre-wired (2 m) *1	55 mm *2	NO	E2E-X8B1D18 2M	E2E-X8C118 2M
			NC	E2E-X8B218 2M	E2E-X8C218 2M
			NO+NC	E2E-X8B3D18 2M	E2E-X8C318 2M
		77 mm	NO	E2E-X8B1DL18 2M	E2E-X8C1L18 2M
			NC	E2E-X8B2L18 2M	E2E-X8C2L18 2M
			NO+NC	E2E-X8B3DL18 2M	E2E-X8C3L18 2M
	M12 Pre-wired Smartclick Connector (0.3 m)	55 mm *3	NO	E2E-X8B1D18-M1TJ 0.3M	E2E-X8C118-M1TJ 0.3M
			NC	E2E-X8B218-M1TJ 0.3M	E2E-X8C218-M1TJ 0.3M
			NO+NC	E2E-X8B3D18-M1TJ 0.3M	E2E-X8C318-M1TJ 0.3M
		77 mm	NO	E2E-X8B1DL18-M1TJ 0.3M	E2E-X8C1L18-M1TJ 0.3M
			NC	E2E-X8B2L18-M1TJ 0.3M	E2E-X8C2L18-M1TJ 0.3M
			NO+NC	E2E-X8B3DL18-M1TJ 0.3M	E2E-X8C3L18-M1TJ 0.3M
	M12 Connector	53 mm	NO	E2E-X8B1D18-M1	E2E-X8C118-M1
			NC	E2E-X8B218-M1	E2E-X8C218-M1
			NO+NC	E2E-X8B3D18-M1	E2E-X8C318-M1
		75 mm	NO	E2E-X8B1DL18-M1	E2E-X8C1L18-M1
			NC	E2E-X8B2L18-M1	E2E-X8C2L18-M1
			NO+NC	E2E-X8B3DL18-M1	E2E-X8C3L18-M1
M30 (15 mm)	Pre-wired (2 m) *1	60 mm *2	NO	E2E-X15B1D30 2M	E2E-X15C130 2M
			NC	E2E-X15B230 2M	E2E-X15C230 2M
			NO+NC	E2E-X15B3D30 2M	E2E-X15C330 2M
		82 mm	NO	E2E-X15B1DL30 2M	E2E-X15C1L30 2M
			NC	E2E-X15B2L30 2M	E2E-X15C2L30 2M
			NO+NC	E2E-X15B3DL30 2M	E2E-X15C3L30 2M
	M12 Pre-wired Smartclick Connector (0.3 m)	60 mm *3	NO	E2E-X15B1D30-M1TJ 0.3M	E2E-X15C130-M1TJ 0.3M
			NC	E2E-X15B230-M1TJ 0.3M	E2E-X15C230-M1TJ 0.3M
			NO+NC	E2E-X15B3D30-M1TJ 0.3M	E2E-X15C330-M1TJ 0.3M
		82 mm	NO	E2E-X15B1DL30-M1TJ 0.3M	E2E-X15C1L30-M1TJ 0.3M
			NC	E2E-X15B2L30-M1TJ 0.3M	E2E-X15C2L30-M1TJ 0.3M
			NO+NC	E2E-X15B3DL30-M1TJ 0.3M	E2E-X15C3L30-M1TJ 0.3M
	M12 Connector	58 mm	NO	E2E-X15B1D30-M1	E2E-X15C130-M1
			NC	E2E-X15B230-M1	E2E-X15C230-M1
			NO+NC	E2E-X15B3D30-M1	E2E-X15C330-M1
		80 mm	NO	E2E-X15B1DL30-M1	E2E-X15C1L30-M1
			NC	E2E-X15B2L30-M1	E2E-X15C2L30-M1
			NO+NC	E2E-X15B3DL30-M1	E2E-X15C3L30-M1

\*1. Models with 5-m cable length are also available (Example: E2E-X2B1D8 5M)

\*2. Models with 2-m and 5-m robot (bending-resistant) cables are also available with "-R" in the model number. (Example: E2E-X2B1D8-R 2M/ E2E-X2B1D8-R 5M)

\*3. Models with M12 Smartclick connector model robot (bending-resistant) cables are also available with "R" in the model number. (Example: E2E-X4B1T12-M1TJR 0.3M)

**Note:** 1. Models in   are equipped with IO-Link (COM2). For IO-Link (COM3), select a model number with the format of "E2E-X    " (Example: E2E-X2B1T8 2M).

Operation mode NO can be changed to NC via IO-Link communications.

2. IO-Link is not supported for NC-type PNP outputs or all types of NPN outputs.



BASIC Model

DC 3-wire (Double distance model) [Refer to *Dimensions* on page 80.]  
Unshielded

Size (Sensing distance)	Connection method	Body size	Operation mode	Model		
				PNP	NPN	
M8 (4 mm)	Pre-wired (2 m) *1	38 mm *2	NO	E2E-X4MB1D8 2M	E2E-X4MC18 2M	
			NC	E2E-X4MB28 2M	E2E-X4MC28 2M	
		48 mm	NO	E2E-X4MB1DL8 2M	E2E-X4MC1L8 2M	
			NC	E2E-X4MB2L8 2M	E2E-X4MC2L8 2M	
		M12 Pre-wired Smartclick Connector (0.3 m)	38 mm *3	NO	E2E-X4MB1D8-M1TJ 0.3M	E2E-X4MC18-M1TJ 0.3M
				NC	E2E-X4MB28-M1TJ 0.3M	E2E-X4MC28-M1TJ 0.3M
	48 mm		NO	E2E-X4MB1DL8-M1TJ 0.3M	E2E-X4MC1L8-M1TJ 0.3M	
			NC	E2E-X4MB2L8-M1TJ 0.3M	E2E-X4MC2L8-M1TJ 0.3M	
	M12 Connector	43 mm	NO	E2E-X4MB1D8-M1	E2E-X4MC18-M1	
			NC	E2E-X4MB28-M1	E2E-X4MC28-M1	
		53 mm	NO	E2E-X4MB1DL8-M1	E2E-X4MC1L8-M1	
			NC	E2E-X4MB2L8-M1	E2E-X4MC2L8-M1	
			NO+NC	E2E-X4MB3DL8-M1	E2E-X4MC3L8-M1	
	M8 Connector (4-pin)	39 mm	NO	E2E-X4MB1D8-M3	E2E-X4MC18-M3	
			NC	E2E-X4MB28-M3	E2E-X4MC28-M3	
		49 mm	NO	E2E-X4MB1DL8-M3	E2E-X4MC1L8-M3	
			NC	E2E-X4MB2L8-M3	E2E-X4MC2L8-M3	
	M8 Connector (3-pin)	39 mm	NO	E2E-X4MB1D8-M5	E2E-X4MC18-M5	
			NC	E2E-X4MB28-M5	E2E-X4MC28-M5	
		49 mm	NO	E2E-X4MB1DL8-M5	E2E-X4MC1L8-M5	
			NC	E2E-X4MB2L8-M5	E2E-X4MC2L8-M5	
	M12 (8 mm)	Pre-wired (2 m) *1	47 mm *2	NO	E2E-X8MB1D12 2M	E2E-X8MC112 2M
				NC	E2E-X8MB212 2M	E2E-X8MC212 2M
NO+NC				E2E-X8MB3D12 2M	E2E-X8MC312 2M	
69 mm			NO	E2E-X8MB1DL12 2M	E2E-X8MC1L12 2M	
			NC	E2E-X8MB2L12 2M	E2E-X8MC2L12 2M	
			NO+NC	E2E-X8MB3DL12 2M	E2E-X8MC3L12 2M	
M12 Pre-wired Smartclick Connector (0.3 m)			47 mm *3	NO	E2E-X8MB1D12-M1TJ 0.3M	E2E-X8MC112-M1TJ 0.3M
				NC	E2E-X8MB212-M1TJ 0.3M	E2E-X8MC212-M1TJ 0.3M
				NO+NC	E2E-X8MB3D12-M1TJ 0.3M	E2E-X8MC312-M1TJ 0.3M
		69 mm	NO	E2E-X8MB1DL12-M1TJ 0.3M	E2E-X8MC1L12-M1TJ 0.3M	
			NC	E2E-X8MB2L12-M1TJ 0.3M	E2E-X8MC2L12-M1TJ 0.3M	
			NO+NC	E2E-X8MB3DL12-M1TJ 0.3M	E2E-X8MC3L12-M1TJ 0.3M	
M12 Connector		48 mm	NO	E2E-X8MB1D12-M1	E2E-X8MC112-M1	
			NC	E2E-X8MB212-M1	E2E-X8MC212-M1	
			NO+NC	E2E-X8MB3D12-M1	E2E-X8MC312-M1	
		70 mm	NO	E2E-X8MB1DL12-M1	E2E-X8MC1L12-M1	
			NC	E2E-X8MB2L12-M1	E2E-X8MC2L12-M1	
			NO+NC	E2E-X8MB3DL12-M1	E2E-X8MC3L12-M1	

Triple distance model

Standard/Double/Single distance model

DC 2-wire

DC 3-wire

DC 2-wire

DC 3-wire

DC 2-wire

# E2E NEXT Series

## BASIC Model

Size (Sensing distance)	Connection method	Body size	Operation mode	Model	
				PNP	NPN
M18 (16 mm)	Pre-wired (2 m) *1	55 mm *2	NO	E2E-X16MB1D18 2M	E2E-X16MC118 2M
			NC	E2E-X16MB218 2M	E2E-X16MC218 2M
			NO+NC	E2E-X16MB3D18 2M	E2E-X16MC318 2M
		77 mm	NO	E2E-X16MB1DL18 2M	E2E-X16MC1L18 2M
			NC	E2E-X16MB2L18 2M	E2E-X16MC2L18 2M
			NO+NC	E2E-X16MB3DL18 2M	E2E-X16MC3L18 2M
	M12 Pre-wired Smartclick Connector (0.3 m)	55 mm *3	NO	E2E-X16MB1D18-M1TJ 0.3M	E2E-X16MC118-M1TJ 0.3M
			NC	E2E-X16MB218-M1TJ 0.3M	E2E-X16MC218-M1TJ 0.3M
			NO+NC	E2E-X16MB3D18-M1TJ 0.3M	E2E-X16MC318-M1TJ 0.3M
		77 mm	NO	E2E-X16MB1DL18-M1TJ 0.3M	E2E-X16MC1L18-M1TJ 0.3M
			NC	E2E-X16MB2L18-M1TJ 0.3M	E2E-X16MC2L18-M1TJ 0.3M
			NO+NC	E2E-X16MB3DL18-M1TJ 0.3M	E2E-X16MC3L18-M1TJ 0.3M
	M12 Connector	53 mm	NO	E2E-X16MB1D18-M1	E2E-X16MC118-M1
			NC	E2E-X16MB218-M1	E2E-X16MC218-M1
			NO+NC	E2E-X16MB3D18-M1	E2E-X16MC318-M1
75 mm		NO	E2E-X16MB1DL18-M1	E2E-X16MC1L18-M1	
		NC	E2E-X16MB2L18-M1	E2E-X16MC2L18-M1	
		NO+NC	E2E-X16MB3DL18-M1	E2E-X16MC3L18-M1	
M30 (30 mm)	Pre-wired (2 m) *1	82 mm *2	NO	E2E-X30MB1DL30 2M	E2E-X30MC1L30 2M
			NC	E2E-X30MB2L30 2M	E2E-X30MC2L30 2M
			NO+NC	E2E-X30MB3DL30 2M	E2E-X30MC3L30 2M
	M12 Pre-wired Smartclick Connector (0.3 m)	82 mm *3	NO	E2E-X30MB1DL30-M1TJ 0.3M	E2E-X30MC1L30-M1TJ 0.3M
			NC	E2E-X30MB2L30-M1TJ 0.3M	E2E-X30MC2L30-M1TJ 0.3M
			NO+NC	E2E-X30MB3DL30-M1TJ 0.3M	E2E-X30MC3L30-M1TJ 0.3M
	M12 Connector	80 mm	NO	E2E-X30MB1DL30-M1	E2E-X30MC1L30-M1
			NC	E2E-X30MB2L30-M1	E2E-X30MC2L30-M1
			NO+NC	E2E-X30MB3DL30-M1	E2E-X30MC3L30-M1

\*1. Models with 5-m cable length are also available (Example: E2E-X8MB1D12 5M)

\*2. Models with 2-m and 5-m robot (bending-resistant) cables are also available with "-R" in the model number. (Example: E2E-X8MB1D12-R 2M/ E2E-X8MB1D12-R 5M)

\*3. Models with M12 Smartclick connector model robot (bending-resistant) cables are also available with "R" in the model number. (Example: E2E-X8MB1D12-M1TJR 0.3M)

**Note:** 1. Models in   are equipped with IO-Link (COM2). For IO-Link (COM3), select a model number with the format of "E2E-X□□□□□"  
(Example: E2E-X8MB1T12 2M).

Operation mode NO can be changed to NC via IO-Link communications.

2. IO-Link is not supported for NC-type PNP outputs or all types of NPN outputs.

BASIC Model

DC 3-wire (Single distance model) [Refer to Dimensions on page 79.]  
Shielded

Size (Sensing distance)	Connection method	Body size	Operation mode	Model		
				PNP	NPN	
M8 (1.5 mm)	Pre-wired (2 m) *1	38 mm *2	NO	E2E-X1R5B1D8 2M	E2E-X1R5C18 2M	
			NC	E2E-X1R5B28 2M	E2E-X1R5C28 2M	
		48 mm	NO	E2E-X1R5B1DL8 2M	E2E-X1R5C1L8 2M	
			NC	E2E-X1R5B2L8 2M	E2E-X1R5C2L8 2M	
		M12 Pre-wired Smartclick Connector (0.3 m)	38 mm *3	NO	E2E-X1R5B1D8-M1TJ 0.3M	E2E-X1R5C18-M1TJ 0.3M
				NC	E2E-X1R5B28-M1TJ 0.3M	E2E-X1R5C28-M1TJ 0.3M
	48 mm		NO	E2E-X1R5B1DL8-M1TJ 0.3M	E2E-X1R5C1L8-M1TJ 0.3M	
			NC	E2E-X1R5B2L8-M1TJ 0.3M	E2E-X1R5C2L8-M1TJ 0.3M	
	M12 Connector	43 mm	NO	E2E-X1R5B1D8-M1	E2E-X1R5C18-M1	
			NC	E2E-X1R5B28-M1	E2E-X1R5C28-M1	
		53 mm	NO	E2E-X1R5B1DL8-M1	E2E-X1R5C1L8-M1	
			NC	E2E-X1R5B2L8-M1	E2E-X1R5C2L8-M1	
			NO+NC	E2E-X1R5B3DL8-M1	E2E-X1R5C3L8-M1	
	M8 Connector (4-pin)	39 mm	NO	E2E-X1R5B1D8-M3	E2E-X1R5C18-M3	
			NC	E2E-X1R5B28-M3	E2E-X1R5C28-M3	
		49 mm	NO	E2E-X1R5B1DL8-M3	E2E-X1R5C1L8-M3	
			NC	E2E-X1R5B2L8-M3	E2E-X1R5C2L8-M3	
	M8 Connector (3-pin)	39 mm	NO	E2E-X1R5B1D8-M5	E2E-X1R5C18-M5	
			NC	E2E-X1R5B28-M5	E2E-X1R5C28-M5	
		49 mm	NO	E2E-X1R5B1DL8-M5	E2E-X1R5C1L8-M5	
			NC	E2E-X1R5B2L8-M5	E2E-X1R5C2L8-M5	
	M12 (2 mm)	Pre-wired (2 m) *1	47 mm *2	NO	E2E-X2B1D12 2M *4	E2E-X2C112 2M *4
				NC	E2E-X2B212 2M	E2E-X2C212 2M
NO+NC				E2E-X2B3D12 2M	E2E-X2C312 2M	
69 mm			NO	E2E-X2B1DL12 2M	E2E-X2C1L12 2M	
			NC	E2E-X2B2L12 2M	E2E-X2C2L12 2M	
			NO+NC	E2E-X2B3DL12 2M	E2E-X2C3L12 2M	
M12 Pre-wired Smartclick Connector (0.3 m)			47 mm *3	NO	E2E-X2B1D12-M1TJ 0.3M	E2E-X2C112-M1TJ 0.3M
				NC	E2E-X2B212-M1TJ 0.3M	E2E-X2C212-M1TJ 0.3M
				NO+NC	E2E-X2B3D12-M1TJ 0.3M	E2E-X2C312-M1TJ 0.3M
		69 mm	NO	E2E-X2B1DL12-M1TJ 0.3M	E2E-X2C1L12-M1TJ 0.3M	
			NC	E2E-X2B2L12-M1TJ 0.3M	E2E-X2C2L12-M1TJ 0.3M	
			NO+NC	E2E-X2B3DL12-M1TJ 0.3M	E2E-X2C3L12-M1TJ 0.3M	
M12 Connector		48 mm	NO	E2E-X2B1D12-M1	E2E-X2C112-M1	
			NC	E2E-X2B212-M1	E2E-X2C212-M1	
			NO+NC	E2E-X2B3D12-M1	E2E-X2C312-M1	
		70 mm	NO	E2E-X2B1DL12-M1	E2E-X2C1L12-M1	
			NC	E2E-X2B2L12-M1	E2E-X2C2L12-M1	
			NO+NC	E2E-X2B3DL12-M1	E2E-X2C3L12-M1	

Triple distance model

Standard/Double/Single distance model

DC 2-wire  
DC 2-wire

DC 3-wire

XS5 NEXT Series

XS5

XS3

# E2E NEXT Series

## BASIC Model

Size (Sensing distance)	Connection method	Body size	Operation mode	Model	
				PNP	NPN
M18 (5 mm)	Pre-wired (2 m) *1	55 mm *2	NO	E2E-X5B1D18 2M *4	E2E-X5C118 2M *4
			NC	E2E-X5B218 2M	E2E-X5C218 2M *4
			NO+NC	E2E-X5B3D18 2M	E2E-X5C318 2M
		77 mm	NO	E2E-X5B1DL18 2M	E2E-X5C1L18 2M
			NC	E2E-X5B2L18 2M	E2E-X5C2L18 2M
			NO+NC	E2E-X5B3DL18 2M	E2E-X5C3L18 2M
	M12 Pre-wired Smartclick Connector (0.3 m)	55 mm *3	NO	E2E-X5B1D18-M1TJ 0.3M	E2E-X5C118-M1TJ 0.3M
			NC	E2E-X5B218-M1TJ 0.3M	E2E-X5C218-M1TJ 0.3M
			NO+NC	E2E-X5B3D18-M1TJ 0.3M	E2E-X5C318-M1TJ 0.3M
		77 mm	NO	E2E-X5B1DL18-M1TJ 0.3M	E2E-X5C1L18-M1TJ 0.3M
			NC	E2E-X5B2L18-M1TJ 0.3M	E2E-X5C2L18-M1TJ 0.3M
			NO+NC	E2E-X5B3DL18-M1TJ 0.3M	E2E-X5C3L18-M1TJ 0.3M
	M12 Connector	53 mm	NO	E2E-X5B1D18-M1	E2E-X5C118-M1 *4
			NC	E2E-X5B218-M1	E2E-X5C218-M1
			NO+NC	E2E-X5B3D18-M1	E2E-X5C318-M1
		75 mm	NO	E2E-X5B1DL18-M1	E2E-X5C1L18-M1
			NC	E2E-X5B2L18-M1	E2E-X5C2L18-M1
			NO+NC	E2E-X5B3DL18-M1	E2E-X5C3L18-M1
M30 (10 mm)	Pre-wired (2 m) *1	60 mm *2	NO	E2E-X10B1D30 2M	E2E-X10C130 2M *4
			NC	E2E-X10B230 2M	E2E-X10C230 2M
			NO+NC	E2E-X10B3D30 2M	E2E-X10C330 2M
		82 mm	NO	E2E-X10B1DL30 2M	E2E-X10C1L30 2M
			NC	E2E-X10B2L30 2M	E2E-X10C2L30 2M
			NO+NC	E2E-X10B3DL30 2M	E2E-X10C3L30 2M
	M12 Pre-wired Smartclick Connector (0.3 m)	60 mm *3	NO	E2E-X10B1D30-M1TJ 0.3M	E2E-X10C130-M1TJ 0.3M *4
			NC	E2E-X10B230-M1TJ 0.3M	E2E-X10C230-M1TJ 0.3M
			NO+NC	E2E-X10B3D30-M1TJ 0.3M	E2E-X10C330-M1TJ 0.3M
		82 mm	NO	E2E-X10B1DL30-M1TJ 0.3M	E2E-X10C1L30-M1TJ 0.3M
			NC	E2E-X10B2L30-M1TJ 0.3M	E2E-X10C2L30-M1TJ 0.3M
			NO+NC	E2E-X10B3DL30-M1TJ 0.3M	E2E-X10C3L30-M1TJ 0.3M
	M12 Connector	58 mm	NO	E2E-X10B1D30-M1	E2E-X10C130-M1
			NC	E2E-X10B230-M1	E2E-X10C230-M1
			NO+NC	E2E-X10B3D30-M1	E2E-X10C330-M1
		80 mm	NO	E2E-X10B1DL30-M1	E2E-X10C1L30-M1
			NC	E2E-X10B2L30-M1	E2E-X10C2L30-M1
			NO+NC	E2E-X10B3DL30-M1	E2E-X10C3L30-M1

\*1. Models with 5-m cable length are also available (Example: E2E-X2B1D12 5M)

\*2. Models with 2-m and 5-m robot (bending-resistant) cables are also available with "-R" in the model number. (Example: E2E-X2B1D12-R 2M/ E2E-X2B1D12-R 5M)

\*3. Models with M12 Smartclick connector model robot (bending-resistant) cables are also available with R" in the model number. (Example: E2E-X2B1D12-M1TJR 0.3M)

\*4. Models with different frequencies are also available. The model number is E2E-X□□□5□ (Example: E2E-X2B15D12 2M).

**Note:** 1. Models in   are equipped with IO-Link (COM2). For IO-Link (COM3), select a model number with the format of "E2E-X□□□T□" (Example: E2E-X2B1T12 2M).

Operation mode NO can be changed to NC via IO-Link communications.

2. IO-Link is not supported for NC-type PNP outputs or all types of NPN outputs.

BASIC Model

DC 3-wire (Single distance model) [Refer to Dimensions on page 80.]  
Unshielded

Size (Sensing distance)	Connection method	Body size	Operation mode	Model			
				PNP	NPN		
M8 (2mm)	Pre-wired (2 m) *1	38 mm *2	NO	E2E-X2MB1D8 2M	E2E-X2MC18 2M		
			NC	E2E-X2MB28 2M	E2E-X2MC28 2M		
		48 mm	NO	E2E-X2MB1DL8 2M	E2E-X2MC1L8 2M		
			NC	E2E-X2MB2L8 2M	E2E-X2MC2L8 2M		
		M12 Pre-wired Smartclick Connector (0.3 m)	38 mm *3	NO	E2E-X2MB1D8-M1TJ 0.3M	E2E-X2MC18-M1TJ 0.3M	
				NC	E2E-X2MB28-M1TJ 0.3M	E2E-X2MC28-M1TJ 0.3M	
	48 mm		NO	E2E-X2MB1DL8-M1TJ 0.3M	E2E-X2MC1L8-M1TJ 0.3M		
			NC	E2E-X2MB2L8-M1TJ 0.3M	E2E-X2MC2L8-M1TJ 0.3M		
	M12 Connector	43 mm	NO	E2E-X2MB1D8-M1	E2E-X2MC18-M1		
			NC	E2E-X2MB28-M1	E2E-X2MC28-M1		
		53 mm	NO	E2E-X2MB1DL8-M1	E2E-X2MC1L8-M1		
			NC	E2E-X2MB2L8-M1	E2E-X2MC2L8-M1		
		NO+NC		E2E-X2MB3DL8-M1	E2E-X2MC3L8-M1		
	M8 Connector (4-pin)	39 mm	NO	E2E-X2MB1D8-M3	E2E-X2MC18-M3		
			NC	E2E-X2MB28-M3	E2E-X2MC28-M3		
		49 mm	NO	E2E-X2MB1DL8-M3	E2E-X2MC1L8-M3		
			NC	E2E-X2MB2L8-M3	E2E-X2MC2L8-M3		
		M8 Connector (3-pin)	39 mm	NO	E2E-X2MB1D8-M5	E2E-X2MC18-M5	
				NC	E2E-X2MB28-M5	E2E-X2MC28-M5	
	49 mm		NO	E2E-X2MB1DL8-M5	E2E-X2MC1L8-M5		
			NC	E2E-X2MB2L8-M5	E2E-X2MC2L8-M5		
	M12 (5mm)		Pre-wired (2 m) *1	47 mm *2	NO	E2E-X5MB1D12 2M	E2E-X5MC112 2M *4
					NC	E2E-X5MB212 2M	E2E-X5MC212 2M *4
NO+NC		E2E-X5MB3D12 2M			E2E-X5MC312 2M		
69 mm		NO		E2E-X5MB1DL12 2M	E2E-X5MC1L12 2M		
		NC		E2E-X5MB2L12 2M	E2E-X5MC2L12 2M		
		NO+NC		E2E-X5MB3DL12 2M	E2E-X5MC3L12 2M		
M12 Pre-wired Smartclick Connector (0.3 m)		47 mm *3		NO	E2E-X5MB1D12-M1TJ 0.3M	E2E-X5MC112-M1TJ 0.3M	
				NC	E2E-X5MB212-M1TJ 0.3M	E2E-X5MC212-M1TJ 0.3M	
				NO+NC	E2E-X5MB3D12-M1TJ 0.3M	E2E-X5MC312-M1TJ 0.3M	
		69 mm	NO	E2E-X5MB1DL12-M1TJ 0.3M	E2E-X5MC1L12-M1TJ 0.3M		
			NC	E2E-X5MB2L12-M1TJ 0.3M	E2E-X5MC2L12-M1TJ 0.3M		
			NO+NC	E2E-X5MB3DL12-M1TJ 0.3M	E2E-X5MC3L12-M1TJ 0.3M		
M12 Connector		48 mm	NO	E2E-X5MB1D12-M1	E2E-X5MC112-M1		
			NC	E2E-X5MB212-M1	E2E-X5MC212-M1		
			NO+NC	E2E-X5MB3D12-M1	E2E-X5MC312-M1		
		70 mm	NO	E2E-X5MB1DL12-M1	E2E-X5MC1L12-M1		
			NC	E2E-X5MB2L12-M1	E2E-X5MC2L12-M1		
			NO+NC	E2E-X5MB3DL12-M1	E2E-X5MC3L12-M1		

Triple distance model

Standard/Double/Single distance model

DC 3-wire

XS5 NEXT Series

XS5

XS3

# E2E NEXT Series

## BASIC Model

Size (Sensing distance)	Connection method	Body size	Operation mode	Model	
				PNP	NPN
M18 (10mm)	Pre-wired (2 m) *1	55 mm *2	NO	E2E-X10MB1D18 2M	E2E-X10MC118 2M *4
			NC	E2E-X10MB218 2M	E2E-X10MC218 2M *4
			NO+NC	E2E-X10MB3D18 2M	E2E-X10MC318 2M
		77 mm	NO	E2E-X10MB1DL18 2M	E2E-X10MC1L18 2M
			NC	E2E-X10MB2L18 2M	E2E-X10MC2L18 2M
			NO+NC	E2E-X10MB3DL18 2M	E2E-X10MC3L18 2M
	M12 Pre-wired Smartclick Connector (0.3 m)	55 mm *3	NO	E2E-X10MB1D18-M1TJ 0.3M	E2E-X10MC118-M1TJ 0.3M
			NC	E2E-X10MB218-M1TJ 0.3M	E2E-X10MC218-M1TJ 0.3M
			NO+NC	E2E-X10MB3D18-M1TJ 0.3M	E2E-X10MC318-M1TJ 0.3M
		77 mm	NO	E2E-X10MB1DL18-M1TJ 0.3M	E2E-X10MC1L18-M1TJ 0.3M
			NC	E2E-X10MB2L18-M1TJ 0.3M	E2E-X10MC2L18-M1TJ 0.3M
			NO+NC	E2E-X10MB3DL18-M1TJ 0.3M	E2E-X10MC3L18-M1TJ 0.3M
	M12 Connector	53 mm	NO	E2E-X10MB1D18-M1	E2E-X10MC118-M1 *4
			NC	E2E-X10MB218-M1	E2E-X10MC218-M1
			NO+NC	E2E-X10MB3D18-M1	E2E-X10MC318-M1
		75 mm	NO	E2E-X10MB1DL18-M1	E2E-X10MC1L18-M1
			NC	E2E-X10MB2L18-M1	E2E-X10MC2L18-M1
			NO+NC	E2E-X10MB3DL18-M1	E2E-X10MC3L18-M1
M30 (18mm)	Pre-wired (2 m) *1	60 mm *2	NO	E2E-X18MB1D30 2M *4	E2E-X18MC130 2M *4
			NC	E2E-X18MB230 2M	E2E-X18MC230 2M *4
			NO+NC	E2E-X18MB3D30 2M	E2E-X18MC330 2M
		82 mm	NO	E2E-X18MB1DL30 2M	E2E-X18MC1L30 2M
			NC	E2E-X18MB2L30 2M	E2E-X18MC2L30 2M
			NO+NC	E2E-X18MB3DL30 2M	E2E-X18MC3L30 2M
	M12 Pre-wired Smartclick Connector (0.3 m)	60 mm *3	NO	E2E-X18MB1D30-M1TJ 0.3M	E2E-X18MC130-M1TJ 0.3M
			NC	E2E-X18MB230-M1TJ 0.3M	E2E-X18MC230-M1TJ 0.3M
			NO+NC	E2E-X18MB3D30-M1TJ 0.3M	E2E-X18MC330-M1TJ 0.3M
		82 mm	NO	E2E-X18MB1DL30-M1TJ 0.3M	E2E-X18MC1L30-M1TJ 0.3M
			NC	E2E-X18MB2L30-M1TJ 0.3M	E2E-X18MC2L30-M1TJ 0.3M
			NO+NC	E2E-X18MB3DL30-M1TJ 0.3M	E2E-X18MC3L30-M1TJ 0.3M
	M12 Connector	58 mm	NO	E2E-X18MB1D30-M1	E2E-X18MC130-M1
			NC	E2E-X18MB230-M1	E2E-X18MC230-M1
			NO+NC	E2E-X18MB3D30-M1	E2E-X18MC330-M1
		80 mm	NO	E2E-X18MB1DL30-M1	E2E-X18MC1L30-M1
			NC	E2E-X18MB2L30-M1	E2E-X18MC2L30-M1
			NO+NC	E2E-X18MB3DL30-M1	E2E-X18MC3L30-M1

\*1. Models with 5-m cable length are also available (Example: E2E-X5MB1D12 5M)

\*2. Models with 2-m and 5-m robot (bending-resistant) cables are also available with "R" in the model number. (Example: E2E-X5MB1D12-R 2M/ E2E-X5MB1D12-R 5M)

\*3. Models with M12 Smartclick connector model robot (bending-resistant) cables are also available with R" in the model number. (Example: E2E-X5MB1D12-M1TJR 2M)

\*4. Models with different frequencies are also available. The model number is E2E-X□□□5□ (Example: E2E-X10MC1518 2M).

**Note:** 1. Models in   are equipped with IO-Link (COM2). For IO-Link (COM3), select a model number with the format of "E2E-X□□□T□" (Example: E2E-X5MB1T12 2M).

Operation mode NO can be changed to NC via IO-Link communications.

2. IO-Link is not supported for NC-type PNP outputs or all types of NPN outputs.

### Accessories (Sold Separately)

e-jig (Mounting Sleeves) [Refer to Dimensions on page 83.]

A Mounting Bracket is not provided with the Sensor. It must be ordered separately as required.

Appearance	Model	Applicable Sensor size	Applicable Sensor type
	Y92E-J8S12	M8	Triple distance model Shielded models Pre-wired models Standard body-sized
	Y92E-J12S18	M12	
	Y92E-J18S30	M18	

### Nut Sets

A Nut Set is included with the Sensor. Order a Nut Set when required, e.g., if you lose the nuts.

Model	Applicable Sensors	Applicable Sensor diameter	Set contents
Y92E-NWM08-E2EN	E2E NEXT Series Quadruple distance/Triple distance model (Shielded models)	M8	Clamping nuts (bronze with nickel plating): 2 Toothed washer (iron with zinc plating): 2
Y92E-NWM12-E2EN		M12	
Y92E-NWM18-E2EN		M18	
Y92E-NWM30-E2EN		M30	
Y92E-NWM08-E2E	E2E NEXT Series Quadruple distance/Triple distance model (Unshielded models) Double distance/Single distance model (Shielded/Unshielded models)	M8	Clamping nuts (bronze with nickel plating): 2 Toothed washer (iron with zinc plating): 1
Y92E-NWM12-E2E		M12	
Y92E-NWM18-E2E		M18	
Y92E-NWM30-E2E		M30	

### Sensor I/O Connectors (Sold Separately)

For details of the connector, refer to XS5 NEXT Series Round Oil-resistant Connectors (M12 Smartclick) on page 84.

For details of the connector, refer to XS5 Series Round Water-resistant Connectors (M12 Smartclick) on page 87.

For details of the connector, refer to XS3 Series Round Water-resistant Connectors (M8) on page 91.

Triple distance model  
DC 2-wire

Standard/Double/Single distance model  
DC 2-wire

DC 3-wire

XS5 NEXT Series

XS5

XS3

# E2E NEXT Series

## Ratings and Specifications

### PREMIUM Model

#### DC 3-wire (Quadruple/Triple distance model) Shielded

Item	Types Size Model	Quadruple distance model				Triple distance model			
		M8	M12	M18	M30	M8	M12	M18	M30
		<b>E2E-X4□8</b>	<b>E2E-X9□12</b>	<b>E2E-X14□18</b>	<b>E2E-X23□30</b>	<b>E2E-X3□8</b>	<b>E2E-X6□12</b>	<b>E2E-X12□18</b>	<b>E2E-X22□30</b>
<b>Sensing distance</b>		4 mm±10%	9 mm±10%	14 mm±10%	23 mm±10%	3 mm±10%	6 mm±10%	12 mm±10%	22 mm±10%
<b>Setting distance</b>		0 to 3 mm	0 to 6.8 mm	0 to 10.6 mm	0 to 17.6 mm	0 to 2.4 mm	0 to 4.8 mm	0 to 9.6 mm	0 to 16.8 mm
<b>Differential travel</b>		15% max. of sensing distance							
<b>Detectable object</b>		Ferrous metals (For non-ferrous metals, refer to the <i>Engineering Data</i> on page 64.)							
<b>Standard sensing object</b>		Iron, 12 × 12 × 1 mm	Iron, 27 × 27 × 1 mm	Iron, 42 × 42 × 1 mm	Iron, 69 × 69 × 1 mm	Iron, 9 × 9 × 1 mm	Iron, 18 × 18 × 1 mm	Iron, 36 × 36 × 1 mm	Iron, 66 × 66 × 1 mm
<b>Response frequency *1</b>		700 Hz	700 Hz	350 Hz	200 Hz	1,000 Hz	800 Hz	500 Hz	200 Hz
<b>Power supply voltage</b>		10 to 30 VDC (including 10% ripple (p-p)), Class 2							
<b>Current consumption</b>		1-output models: 16 mA max.				1-output models: 16 mA max., 2-output models: 20 mA max.			
<b>Output configuration</b>		B□ Models: PNP open collector, C□ Models: NPN open collector							
<b>Operation mode (with sensing object approaching)</b>		1-output models (B1, C1): NO (Normally open), 1-output models (B2, C2): NC (Normally closed)				1-output models (B1, C1): NO (Normally open), 1-output models (B2, C2): NC (Normally closed), 2-output models (B3, C3): NO+NC (Normally open, Normally closed)			
<b>Control output</b>	<b>Load current</b>	1-output models: 10 to 30 VDC, Class 2, 50 mA max.				1-output models: 10 to 30 VDC, Class 2, 100 mA max.		1-output models: 10 to 30 VDC, Class 2, 100 mA max., 2-output models: 10 to 30 VDC, Class 2, 50 mA max.	
	<b>Residual voltage</b>	1-output models: 2 V max. (Load current: 50 mA, Cable length: 2 m)				1-output models: 2 V max. (Load current: 100 mA, Cable length: 2 m)		1-output models: 2 V max. (Load current: 100 mA, Cable length: 2 m), 2-output models: 2 V max. (Load current: 50 mA, Cable length: 2 m)	
<b>Indicator *2</b>		In the Standard I/O mode (SIO mode): Operation indicator (orange, lit) and communication indicator (green, not lit) In the IO-Link communication mode (COM mode): Operation indicator (orange, lit) and communication indicator (green, blinking at 1 s intervals)							
<b>Protection circuits</b>		Power supply reverse polarity protection, Surge suppressor, Output short-circuit protection, Output reverse polarity protection							
<b>Ambient temperature range</b>		Operating: -25 to 60°C Storage: -25 to 70°C (with no icing or condensation)	Operating/Storage: -25 to 70°C (with no icing or condensation)						
<b>Ambient humidity range</b>		Operating/Storage: 35% to 95% (with no condensation)							
<b>Temperature influence</b>		-15% to 25% max. of sensing distance at 23°C in the temperature range of -25 to 60°C	±15% max. of sensing distance at 23°C in the temperature range of -25 to 70°C			±10% max. of sensing distance at 23°C in the temperature range of -25 to 70°C			
<b>Voltage influence</b>		±1% max. of sensing distance at rated voltage in the rated voltage ±15% range							
<b>Insulation resistance</b>		50 MΩ min. (at 500 VDC) between current-carrying parts and case							
<b>Dielectric strength</b>		1,000 VAC, 50/60 Hz for 1 minute between current-carrying parts and case							
<b>Vibration resistance (destruction)</b>		10 to 55 Hz, 1.5-mm double amplitude for 2 hours each in X, Y, and Z directions							
<b>Shock resistance (destruction)</b>		500 m/s <sup>2</sup> 10 times each in X, Y, and Z directions	1,000 m/s <sup>2</sup> 10 times each in X, Y, and Z directions			500 m/s <sup>2</sup> 10 times each in X, Y, and Z directions	1,000 m/s <sup>2</sup> 10 times each in X, Y, and Z directions		
<b>Degree of protection</b>		Pre-wired Models, Pre-wired Connector Models: IEC 60529: IP67, ISO 20653 (old standard: DIN 40050 PART9): IP69K, JIS C 0920 Annex 1: IP67G, Passed OMRON's Oil-resistant Component Evaluation Standards *3 (Cutting oil type: specified in JIS K 2241: 2000; Temperature: 35°C max.) Connector Models: IEC 60529: IP67, ISO 20653 (old standard: DIN 40050 PART9): IP69K							
<b>Connection method</b>		Pre-wired Models (Standard cable length: 2 m), Pre-wired Connector Models (Standard cable length: 0.3 m) and Connector Models (M12 Connector, M8 (4-pin) Connector and M8 (3-pin) Connector)							
<b>Weight *4 (packed state)</b>	<b>Pre-wired</b>	Approx. 85 g	Approx. 95 g	Approx. 180 g	Approx. 260 g	Approx. 85 g	Approx. 95 g	Approx. 180 g	Approx. 260 g
	<b>M12 Pre-wired Smartclick Connector</b>	Approx. 55 g	Approx. 70 g	Approx. 115 g	Approx. 200 g	Approx. 55 g	Approx. 70 g	Approx. 115 g	Approx. 200 g
	<b>Connector</b>	Approx. 40 g (M8/M12 Connector)	Approx. 55 g	Approx. 95 g	Approx. 180 g	Approx. 40 g (M8/M12 Connector)	Approx. 55 g	Approx. 95 g	Approx. 180 g



Item	Types Size Model	Quadruple distance model				Triple distance model			
		M8	M12	M18	M30	M8	M12	M18	M30
		E2E-X4□8	E2E-X9□12	E2E-X14□18	E2E-X23□30	E2E-X3□8	E2E-X6□12	E2E-X12□18	E2E-X22□30
Materials	Case	Nickel-plated brass							
	Sensing surface	Polybutylene terephthalat (PBT)							
	Clamping nuts	Nickel-plated brass							
	Toothed washers	Zinc-plated iron							
	Cable	Vinyl chloride (PVC) Note: Material of Pre-wired Models and Pre-wired Connector Models.							
Main IO-Link functions*2		Operation mode switching between NO and NC, self diagnosis enabling, excessive proximity judgment distance selecting, timer function of the control output and timer time selecting, instability output (IO-Link mode) ON delay timer time selecting function, monitor output, operating hours read-out, readout of the sensor internal temperature, and initial reset							
IO-Link Communication specifications*2	IO-Link specification	Ver 1.1							
	Baud rate	COM2 (38.4 kbps), COM3 (230.4 kbps)							
	Data length	PD size: 2 bytes, OD size: 1 byte (M-sequence type: TYPE_2_2)							
	Minimum cycle time	COM2: 2.3 ms, COM3: 0.4 ms							
Accessories		Instruction manual, Clamping nuts, Toothed washer							

- \*1. The response frequency is an average value. Measurement conditions are as follows: standard sensing object, a distance of twice the standard sensing object, and a set distance of half the sensing distance.
- \*2. IO-Link is not supported for NC-type PNP outputs or all types of NPN outputs.
- \*3. The Oil-resistant Component Evaluation Standards are OMRON's own durability evaluation standards.  
2-year oil resistance indicates the median value of the product design and the oil-resistance performance criterion result (=Typical value).  
The Pre-wired Connector Model verifies 2 years of oil resistance when mating with Round Oil-resistant Connectors XS5 NEXT series correctly.  
The degree of protection is not satisfied with the part where cable wires are uncovered for the Pre-wired Models.
- \*4. Weight of the standard body-sized model.

# E2E NEXT Series

## PREMIUM Model

### DC 3-wire (Quadruple/Triple distance model) Unshielded

Item	Types Size Model	Quadruple distance model				Triple distance model			
		M8	M12	M18	M30	M8	M12	M18	M30
		E2E-X8M□8	E2E-X16M□12	E2E-X30M□18	E2E-X50M□30	E2E-X6M□8	E2E-X10M□12	E2E-X20M□18	E2E-X40M□30
<b>Sensing distance</b>		8 mm±10%	16 mm±10%	30 mm±10%	50 mm±10%	6 mm±10%	10 mm±10%	20 mm±10%	40 mm±10%
<b>Setting distance</b>		0 to 6 mm	0 to 12.2 mm	0 to 23 mm	0 to 38.2 mm	0 to 4.8 mm	0 to 8 mm	0 to 16 mm	0 to 32 mm
<b>Differential travel</b>		15% max. of sensing distance							
<b>Detectable object</b>		Ferrous metals (For non-ferrous metals, refer to the <i>Engineering Data</i> on page 64.)							
<b>Standard sensing object</b>		Iron, 24 × 24 × 1 mm	Iron, 48 × 48 × 1 mm	Iron, 90 × 90 × 1 mm	Iron, 150 × 150 × 1 mm	Iron, 18 × 18 × 1 mm	Iron, 30 × 30 × 1 mm	Iron, 60 × 60 × 1 mm	Iron, 120 × 120 × 1 mm
<b>Response frequency *1</b>		500 Hz	400 Hz	200 Hz	100 Hz	800 Hz	400 Hz	200 Hz	100 Hz
<b>Power supply voltage</b>		10 to 30 VDC (including 10% ripple (p-p)), Class 2							
<b>Current consumption</b>		1-output models: 16 mA max.				1-output models: 16 mA max., 2-output models: 20 mA max.			
<b>Output configuration</b>		B□ Models: PNP open collector C□ Models: NPN open collector							
<b>Operation mode (with sensing object approaching)</b>		1-output models (B1, C1): NO (Normally open), 1-output models (B2, C2): NC (Normally closed)				1-output models (B1, C1): NO (Normally open), 1-output models (B2, C2): NC (Normally closed), 2-output models (B3, C3): NO+NC (Normally open, Normally closed)			
<b>Control output</b>	<b>Load current</b>	1-output models: 10 to 30 VDC, Class 2, 50 mA max.				1-output models: 10 to 30 VDC, Class 2, 100 mA max.		1-output models: 10 to 30 VDC, Class 2, 100 mA max., 2-output models: 10 to 30 VDC, Class 2, 50 mA max.	
	<b>Residual voltage</b>	1-output models: 2 V max. (Load current: 50 mA, Cable length: 2 m)				1-output models: 2 V max. (Load current: 100 mA, Cable length: 2 m)		1-output models: 2 V max. (Load current: 100 mA, Cable length: 2 m), 2-output models: 2 V max. (Load current: 50 mA, Cable length: 2 m)	
<b>Indicator *2</b>		In the Standard I/O mode (SIO mode): Operation indicator (orange, lit) and communication indicator (green, not lit) In the IO-Link communication mode (COM mode): Operation indicator (orange, lit) and communication indicator (green, blinking at 1 s intervals)							
<b>Protection circuits</b>		Power supply reverse polarity protection, Surge suppressor, Output short-circuit protection, Output reverse polarity protection							
<b>Ambient temperature range</b>		Operating/Storage: -25 to 70°C (with no icing or condensation)							
<b>Ambient humidity range</b>		Operating/Storage: 35% to 95% (with no condensation)							
<b>Temperature influence</b>		±15% max. of sensing distance at 23°C in the temperature range of -25 to 70°C				±10% max. of sensing distance at 23°C in the temperature range of -25 to 70°C			
<b>Voltage influence</b>		±1% max. of sensing distance at rated voltage in the rated voltage ±15% range							
<b>Insulation resistance</b>		50 MΩ min. (at 500 VDC) between current-carrying parts and case							
<b>Dielectric strength</b>		1,000 VAC, 50/60 Hz for 1 minute between current-carrying parts and case							
<b>Vibration resistance (destruction)</b>		10 to 55 Hz, 1.5-mm double amplitude for 2 hours each in X, Y, and Z directions							
<b>Shock resistance (destruction)</b>		500 m/s <sup>2</sup> 10 times each in X, Y, and Z directions	1,000 m/s <sup>2</sup> 10 times each in X, Y, and Z directions			500 m/s <sup>2</sup> 10 times each in X, Y, and Z directions	1,000 m/s <sup>2</sup> 10 times each in X, Y, and Z directions		
<b>Degree of protection</b>		Pre-wired Models, Pre-wired Connector Models: IEC 60529:IP67, ISO 20653 (old standard: DIN 40050 PART9): IP69K, JIS C 0920 Annex 1: IP67G, Passed OMRON's Oil-resistant Component Evaluation Standards *3 (Cutting oil type: specified in JIS K 2241: 2000; Temperature: 35°C max.) Connector Models: IEC 60529: IP67, ISO 20653 (old standard: DIN 40050 PART9): IP69K							
<b>Connection method</b>		Pre-wired Models (Standard cable length: 2 m), Pre-wired Connector Models (Standard cable length: 0.3 m) and Connector Models (M12 Connector, M8 (4-pin) Connector and M8 (3-pin) Connector)							
<b>Weight *4 (packed state)</b>	<b>Pre-wired</b>	Approx. 85 g	Approx. 95 g	Approx. 190 g	Approx. 310 g	Approx. 85 g	Approx. 95 g	Approx. 190 g	Approx. 280 g
	<b>M12 Pre-wired Smartclick Connector</b>	Approx. 55 g	Approx. 70 g	Approx. 125 g	Approx. 250 g	Approx. 55 g	Approx. 70 g	Approx. 125 g	Approx. 220 g
	<b>Connector</b>	Approx. 40 g (M8/M12 Connector)	Approx. 55 g	Approx. 105 g	Approx. 230 g	Approx. 40 g (M8/M12 Connector)	Approx. 55 g	Approx. 105 g	Approx. 200 g

Item	Types Size Model	Quadruple distance model				Triple distance model			
		M8	M12	M18	M30	M8	M12	M18	M30
		E2E-X8M□8	E2E-X16M□12	E2E-X30M□18	E2E-X50M□30	E2E-X6M□8	E2E-X10M□12	E2E-X20M□18	E2E-X40M□30
Materials	Case	Stainless (SUS303)	Nickel-plated brass			Stainless (SUS303)	Nickel-plated brass		
	Sensing surface	Polybutylene terephthalat (PBT)							
	Clamping nuts	Nickel-plated brass							
	Toothed washers	Zinc-plated iron							
	Cable	Vinyl chloride (PVC) Note: Material of Pre-wired Models and Pre-wired Connector Models.							
Main IO-Link functions*2		Operation mode switching between NO and NC, self diagnosis enabling, excessive proximity judgment distance selecting, timer function of the control output and timer time selecting, instability output (IO-Link mode) ON delay timer time selecting function, monitor output, operating hours read-out, readout of the sensor internal temperature, and initial reset							
IO-Link Communication specifications*2	IO-Link specification	Ver1.1							
	Baud rate	COM2 (38.4 kbps), COM3 (230.4 kbps)							
	Data length	PD size: 2 bytes, OD size: 1 byte (M-sequence type: TYPE_2_2)							
	Minimum cycle time	COM2: 2.3 ms, COM3: 0.4 ms							
Accessories		Instruction manual, Clamping nuts, Toothed washer							

- \*1. The response frequency is an average value. Measurement conditions are as follows: standard sensing object, a distance of twice the standard sensing object, and a set distance of half the sensing distance.
- \*2. IO-Link is not supported for NC-type PNP outputs or all types of NPN outputs.
- \*3. The Oil-resistant Component Evaluation Standards are OMRON's own durability evaluation standards. 2-year oil resistance indicates the median value of the product design and the oil-resistance performance criterion result (=Typical value). Actual performance can be expected to decline after two years on average from shipment. The Pre-wired Connector Model verifies 2 years of oil resistance when mating with Round Oil-resistant Connectors XS5 NEXT series correctly. The degree of protection is not satisfied with the part where cable wires are uncovered for the Pre-wired Models.
- \*4. Weight of the standard body-sized model.

Triple distance model  
DC 2-wire

Standard/Double/Single distance model  
DC 2-wire

DC 3-wire

XS5 NEXT Series

XS5

XS3

# E2E NEXT Series

## BASIC Model

### DC 3-wire (Double/Single distance model) Shielded

Item	Types Size Model	Double distance				Single distance			
		M8	M12	M18	M30	M8	M12	M18	M30
		E2E-X2□8	E2E-X4□12	E2E-X8□18	E2E-X15□30	E2E-X1R5□8	E2E-X2□12	E2E-X5□18	E2E-X10□30
<b>Sensing distance</b>		2 mm±10%	4 mm±10%	8 mm±10%	15 mm±10%	1.5 mm±10%	2 mm±10%	5 mm±10%	10 mm±10%
<b>Setting distance</b>		0 to 1.6 mm	0 to 3.2 mm	0 to 6.4 mm	0 to 12 mm	0 to 1.2 mm	0 to 1.6 mm	0 to 4 mm	0 to 8 mm
<b>Differential travel</b>		15% max. of sensing distance				10% max. of sensing distance			
<b>Detectable object</b>		Ferrous metals (For non-ferrous metals, refer to the <i>Engineering Data</i> on page 64.)							
<b>Standard sensing object</b>		Iron, 8 × 8 × 1 mm	Iron, 12 × 12 × 1 mm	Iron, 24 × 24 × 1 mm	Iron, 45 × 45 × 1 mm	Iron, 8 × 8 × 1 mm	Iron, 12 × 12 × 1 mm	Iron, 18 × 18 × 1 mm	Iron, 30 × 30 × 1 mm
<b>Response frequency *1</b>		1,500 Hz	1,000 Hz	500 Hz	250 Hz	2,000 Hz	1,500 Hz	600 Hz	400 Hz
<b>Power supply voltage</b>		10 to 30 VDC (including 10% ripple (p-p)), Class 2							
<b>Current consumption</b>		1-output models: 16 mA max. 2-output models: 20 mA max.							
<b>Output configuration</b>		B□ Models: PNP open collector C□ Models: NPN open collector							
<b>Operation mode (with sensing object approaching)</b>		1-output models (B1, C1): NO (Normally open), 1-output models (B2, C2): NC (Normally closed), 2-output models (B3, C3): NO+NC (Normally open, Normally closed) *3							
<b>Control output</b>	<b>Load current</b>	1-output models: 10 to 30 VDC, Class 2, 200 mA max., (-40 to 70°C), 100 mA max., (70 to 85°C) 2-output models: 10 to 30 VDC, Class 2, 50 mA max.	1-output models: 10 to 30 VDC, Class 2, 200 mA max., 2-output models: 10 to 30 VDC, Class 2, 100 mA max.			1-output models: 10 to 30 VDC, Class 2, 200 mA max., (-40 to 70°C), 100 mA max., (70 to 85°C) 2-output models: 10 to 30 VDC, Class 2, 50 mA max.	1-output models: 10 to 30 VDC, Class 2, 200 mA max., 2-output models: 10 to 30 VDC, Class 2, 100 mA max.		
	<b>Residual voltage</b>	1-output models: 2 V max. (Load current: 200 mA, Cable length: 2 m), 2-output models: 2 V max. (Load current: 50 mA, Cable length: 2 m)	1-output models: 2 V max. (Load current: 200 mA, Cable length: 2 m), 2-output models: 2 V max. (Load current: 100 mA, Cable length: 2 m)			1-output models: 2 V max. (Load current: 200 mA, Cable length: 2 m), 2-output models: 2 V max. (Load current: 50 mA, Cable length: 2 m)	1-output models: 2 V max. (Load current: 200 mA, Cable length: 2 m), 2-output models: 2 V max. (Load current: 100 mA, Cable length: 2 m)		
<b>Indicator *2</b>		In the Standard I/O mode (SIO mode): Operation indicator (orange, lit) and communication indicator (green, not lit) In the IO-Link communication mode (COM mode): Operation indicator (orange, lit) and communication indicator (green, blinking at 1 s intervals)							
<b>Protection circuits</b>		Power supply reverse polarity protection, Surge suppressor, Output short-circuit protection, Output reverse polarity protection							
<b>Ambient temperature range</b>		Operating/Storage: -40 to 85°C (with no icing or condensation) <b>Note:</b> The UL temperature rating for M12 Pre-wired Connector Models is -25 to 70°C.							
<b>Ambient humidity range</b>		Operating/Storage: 35% to 95% (with no condensation)							
<b>Temperature influence</b>		±15% max. of sensing distance at 23°C in the temperature range of -40 to 85°C ±10% max. of sensing distance at 23°C in the temperature range of -25 to 70°C							
<b>Voltage influence</b>		±1% max. of sensing distance at rated voltage in the rated voltage ±15% range							
<b>Insulation resistance</b>		50 MΩ min. (at 500 VDC) between current-carrying parts and case							
<b>Dielectric strength</b>		1,000 VAC, 50/60 Hz for 1 minute between current-carrying parts and case							
<b>Vibration resistance (destruction)</b>		10 to 55 Hz, 1.5-mm double amplitude for 2 hours each in X, Y, and Z directions							
<b>Shock resistance (destruction)</b>		500 m/s <sup>2</sup> 10 times each in X, Y, and Z directions	1,000 m/s <sup>2</sup> 10 times each in X, Y, and Z directions			500 m/s <sup>2</sup> 10 times each in X, Y, and Z directions	1,000 m/s <sup>2</sup> 10 times each in X, Y, and Z directions		
<b>Degree of protection</b>		Pre-wired Models, Pre-wired Connector Models: IEC 60529:IP67, ISO 20653 (old standard: DIN 40050 PART9): IP69K, JIS C 0920 Annex 1: IP67G, Passed OMRON's Oil-resistant Component Evaluation Standards *4 (Cutting oil type: specified in JIS K 2241:2000; Temperature: 35°C max.) Connector Models: IEC 60529: IP67, ISO 20653 (old standard: DIN 40050 PART9): IP69K							
<b>Connection method</b>		Pre-wired Models (Standard cable length: 2 m), Pre-wired Connector Models (Standard cable length: 0.3 m) and Connector Models (M12 Connector, M8 (4-pin) Connector and M8 (3-pin) Connector)							
<b>Weight *5 (packed state)</b>	<b>Pre-wired</b>	Approx. 85 g	Approx. 95 g	Approx. 170 g	Approx. 240 g	Approx. 85 g	Approx. 95 g	Approx. 170 g	Approx. 240 g
	<b>M12 Pre-wired Smartclick Connector</b>	Approx. 55 g	Approx. 70 g	Approx. 105 g	Approx. 170 g	Approx. 55 g	Approx. 70 g	Approx. 105 g	Approx. 170 g
	<b>Connector (M8/M12 Connector)</b>	Approx. 40 g	Approx. 55 g	Approx. 85 g	Approx. 160 g	Approx. 40 g	Approx. 55 g	Approx. 85 g	Approx. 160 g

Item	Types Size Model	Double distance				Single distance			
		M8	M12	M18	M30	M8	M12	M18	M30
		E2E-X2□8	E2E-X4□12	E2E-X8□18	E2E-X15□30	E2E-X1R5□8	E2E-X2□12	E2E-X5□18	E2E-X10□30
Materials	Case	Stainless (SUS303)	Nickel-plated brass			Stainless (SUS303)	Nickel-plated brass		
	Sensing surface	Polybutylene terephthalat (PBT)							
	Clamping nuts	Nickel-plated brass							
	Toothed washers	Zinc-plated iron							
	Cable	Vinyl chloride (PVC) Note: Material of Pre-wired Models and Pre-wired Connector Models.							
Main IO-Link functions *2		Operation mode switching between NO and NC, self diagnosis enabling, excessive proximity judgment distance selecting, timer function of the control output and timer time selecting, instability output (IO-Link mode) ON delay timer time selecting function, monitor output, operating hours read-out, readout of the sensor internal temperature, and initial reset							
IO-Link Communication specifications *2	IO-Link specification	Ver1.1							
	Baud rate	COM2 (38.4 kbps), COM3 (230.4 kbps)							
	Data length	PD size: 2 bytes, OD size: 1 byte (M-sequence type: TYPE_2_2)							
	Minimum cycle time	COM2: 2.3 ms, COM3: 0.4 ms							
Accessories		Instruction manual, Clamping nuts, Toothed washer							

- \*1. The response frequency is an average value. Measurement conditions are as follows: standard sensing object, a distance of twice the standard sensing object, and a set distance of half the sensing distance.
- \*2. IO-Link is not supported for NC-type PNP outputs or all types of NPN outputs.
- \*3. Dual-output specification for the M8-size models is only applicable to long-size M12 Connector models.
- \*4. The Oil-resistant Component Evaluation Standards are OMRON's own durability evaluation standards. 2-year oil resistance indicates the median value of the product design and the oil-resistance performance criterion result (=Typical value). Actual performance can be expected to decline after two years on average from shipment. The Pre-wired Connector Model verifies 2 years of oil resistance when mating with Round Oil-resistant Connectors XS5 NEXT series correctly. The degree of protection is not satisfied with the part where cable wires are uncovered for the Pre-wired Models.
- \*5. Weight of the standard body-sized model.

# E2E NEXT Series

## BASIC Model

### DC 3-wire (Double/Single distance model) Unshielded

Item	Types Size Model	Double distance model				Single distance model			
		M8	M12	M18	M30	M8	M12	M18	M30
		E2E-X4M□8	E2E-X8M□12	E2E-X16M□18	E2E-X30M□30	E2E-X2M□8	E2E-X5M□12	E2E-X10M□18	E2E-X18M□30
<b>Sensing distance</b>		4 mm±10%	8 mm±10%	16 mm±10%	30 mm±10%	2 mm±10%	5 mm±10%	10 mm±10%	18 mm±10%
<b>Setting distance</b>		0 to 3.2 mm	0 to 6.4 mm	0 to 12.8 mm	0 to 24 mm	0 to 1.6 mm	0 to 4 mm	0 to 8 mm	0 to 14.4 mm
<b>Differential travel</b>		15% max. of sensing distance				10% max. of sensing distance			
<b>Detectable object</b>		Ferrous metals (For non-ferrous metals, refer to the <i>Engineering Data</i> on page 64.)							
<b>Standard sensing object</b>		Iron, 12 × 12 × 1 mm	Iron, 24 × 24 × 1 mm	Iron, 48 × 48 × 1 mm	Iron, 90 × 90 × 1 mm	Iron, 8 × 8 × 1 mm	Iron, 15 × 15 × 1 mm	Iron, 30 × 30 × 1 mm	Iron, 54 × 54 × 1 mm
<b>Response frequency *1</b>		1,000 Hz	800 Hz	400 Hz	100 Hz	1,000 Hz	800 Hz	400 Hz	100 Hz
<b>Power supply voltage</b>		10 to 30 VDC (including 10% ripple (p-p)), Class 2							
<b>Current consumption</b>		1-output models: 16 mA max. 2-output models: 20 mA max.							
<b>Output configuration</b>		B□ Models: PNP open collector C□ Models: NPN open collector							
<b>Operation mode (with sensing object approaching)</b>		1-output models (B1, C1): NO (Normally open), 1-output models (B2, C3): NC (Normally closed) 2-output models (B3, C3): NO+NC (Normally open, Normally closed) *3							
<b>Control output</b>	<b>Load current</b>	1-output models: 10 to 30 VDC, Class 2, 200 mA max., (-40 to 70°C), 100 mA max., (70 to 85°C) 2-output models: 10 to 30 VDC, Class 2, 50 mA max.	1-output models: 10 to 30 VDC, Class 2, 200 mA max., 2-output models: 10 to 30 VDC, Class 2, 100 mA max.			1-output models: 10 to 30 VDC, Class 2, 200 mA max., (-40 to 70°C), 100 mA max., (70 to 85°C) 2-output models: 10 to 30 VDC, Class 2, 50 mA max.	1-output models: 10 to 30 VDC, Class 2, 200 mA max., 2-output models: 10 to 30 VDC, Class 2, 100 mA max.		
	<b>Residual voltage</b>	1-output models: 2 V max. (Load current: 200 mA, Cable length: 2 m), 2-output models: 2 V max. (Load current: 50 mA, Cable length: 2 m)	1-output models: 2 V max. (Load current: 200 mA, Cable length: 2 m), 2-output models: 2 V max. (Load current: 100 mA, Cable length: 2 m)			1-output models: 2 V max. (Load current: 200 mA, Cable length: 2 m), 2-output models: 2 V max. (Load current: 50 mA, Cable length: 2 m)	1-output models: 2 V max. (under load current of 200 mA with cable length of 2 m), 2-output models: 2 V max. (under load current of 100 mA with cable length of 2 m)		
<b>Indicator *2</b>		In the Standard I/O mode (SIO mode): Operation indicator (orange, lit) and communication indicator (green, not lit) In the IO-Link communication mode (COM mode): Operation indicator (orange, lit) and communication indicator (green, blinking at 1 s intervals)							
<b>Protection circuits</b>		Power supply reverse polarity protection, Surge suppressor, Output short-circuit protection, Output reverse polarity protection							
<b>Ambient temperature range</b>		Operating/Storage: -40 to 85°C (with no icing or condensation) <b>Note:</b> The UL temperature rating for M12 Pre-wired Connector Models is -25 to 70°C.							
<b>Ambient humidity range</b>		Operating/Storage: 35% to 95% (with no condensation)							
<b>Temperature influence</b>		±15% max. of sensing distance at 23°C in the temperature range of -40 to 85°C ±10% max. of sensing distance at 23°C in the temperature range of -25 to 70°C							
<b>Voltage influence</b>		±1% max. of sensing distance at rated voltage in the rated voltage ±15% range							
<b>Insulation resistance</b>		50 MΩ min. (at 500 VDC) between current-carrying parts and case							
<b>Dielectric strength</b>		1,000 VAC, 50/60 Hz for 1 minute between current-carrying parts and case							
<b>Vibration resistance (destruction)</b>		10 to 55 Hz, 1.5-mm double amplitude for 2 hours each in X, Y, and Z directions							
<b>Shock resistance (destruction)</b>		500 m/s <sup>2</sup> 10 times each in X, Y, and Z directions	1,000 m/s <sup>2</sup> 10 times each in X, Y, and Z directions			500 m/s <sup>2</sup> 10 times each in X, Y, and Z directions	1,000 m/s <sup>2</sup> 10 times each in X, Y, and Z directions		
<b>Degree of protection</b>		Pre-wired Models, Pre-wired Connector Models: IEC 60529:IP67, ISO 20653 (old standard: DIN 40050 PART9): IP69K, JIS C 0920 Annex 1: IP67G, Passed OMRON's Oil-resistant Component Evaluation Standards *4 (Cutting oil type: specified in JIS K 2241:2000; Temperature: 35°C max.) Connector Models: IEC 60529:IP67, ISO 20653 (old standard: DIN 40050 PART9): IP69K							
<b>Connection method</b>		Pre-wired Models (Standard cable length: 2 m), Pre-wired Connector Models (Standard cable length: 0.3 m) and Models (M12 Connector, M8 (4-pin) Connector and M8 (3-pin) Connector)							
<b>Weight *5 (packed state)</b>	<b>Pre-wired</b>	Approx. 85 g	Approx. 95 g	Approx. 170 g	Approx. 280 g	Approx. 85 g	Approx. 95 g	Approx. 170 g	Approx. 240 g
	<b>M12 Pre-wired Smartclick Connector</b>	Approx. 55 g	Approx. 70 g	Approx. 105 g	Approx. 220 g	Approx. 55 g	Approx. 70 g	Approx. 105 g	Approx. 170 g
	<b>Connector (M8/M12 Connector)</b>	Approx. 40 g	Approx. 55 g	Approx. 85 g	Approx. 200 g	Approx. 40 g	Approx. 55 g	Approx. 85 g	Approx. 160 g

Item	Types Size Model	Double distance model				Single distance model			
		M8	M12	M18	M30	M8	M12	M18	M30
		E2E-X4M□8	E2E-X8M□12	E2E-X16M□18	E2E-X30M□30	E2E-X2M□8	E2E-X5M□12	E2E-X10M□18	E2E-X18M□30
Materials	Case	Stainless (SUS303)	Nickel-plated brass			Stainless (SUS303)	Nickel-plated brass		
	Sensing surface	Polybutylene terephthalat (PBT)							
	Clamping nuts	Nickel-plated brass							
	Toothed washers	Zinc-plated iron							
	Cable	Vinyl chloride (PVC) Note: Material of Pre-wired Models and Pre-wired Connector Models.							
Main IO-Link functions *2		Operation mode switching between NO and NC, self diagnosis enabling, excessive proximity judgment distance selecting, timer function of the control output and timer time selecting, instability output (IO-Link mode) ON delay timer time selecting function, monitor output, operating hours read-out, readout of the sensor internal temperature, and initial reset							
IO-Link Communication specifications *2	IO-Link specification	Ver 1.1							
	Baud rate	COM2 (38.4 kbps), COM3 (230.4 kbps)							
	Data length	PD size: 2 bytes, OD size: 1 byte (M-sequence type: TYPE_2_2)							
	Minimum cycle time	COM2: 2.3 ms, COM3: 0.4 ms							
Accessories		Instruction manual, Clamping nuts, Toothed washer							

\*1. The response frequency is an average value. Measurement conditions are as follows: standard sensing object, a distance of twice the standard sensing object, and a set distance of half the sensing distance.

\*2. IO-Link is not supported for NC-type PNP outputs or all types of NPN outputs.

\*3. Dual-output specification for the M8-size models is only applicable to long-size M12 Connector models.

\*4. The Oil-resistant Component Evaluation Standards are OMRON's own durability evaluation standards. 2-year oil resistance indicates the median value of the product design and the oil-resistance performance criterion result (=Typical value). Actual performance can be expected to decline after two years on average from shipment. The Pre-wired Connector Model verifies 2 years of oil resistance when mating with Round Oil-resistant Connectors XS5 NEXT series correctly. The degree of protection is not satisfied with the part where cable wires are uncovered for the Pre-wired Models.

\*5. Weight of the standard body-sized model.

# E2E NEXT Series

## Engineering Data (Reference Value)

### Sensing Area

#### PREMIUM Model

##### Quadruple distance model

###### Shielded

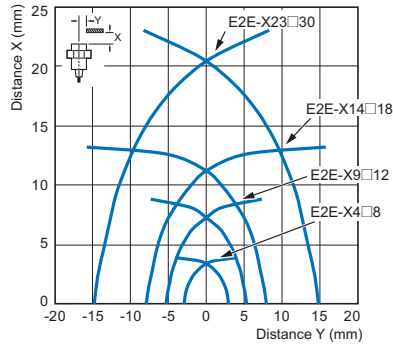

###### Unshielded

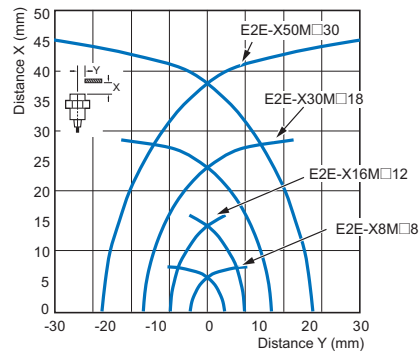

##### Triple distance model

###### Shielded

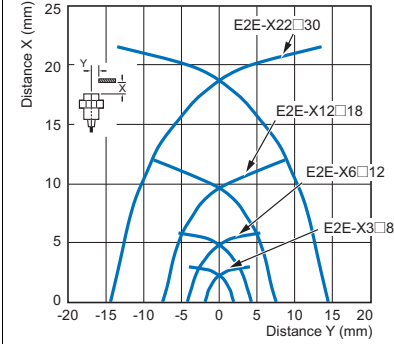

###### Unshielded

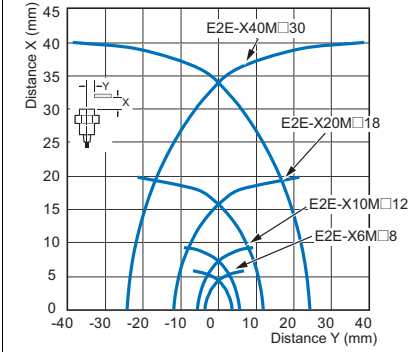

#### BASIC Model

##### Double distance model

###### Shielded

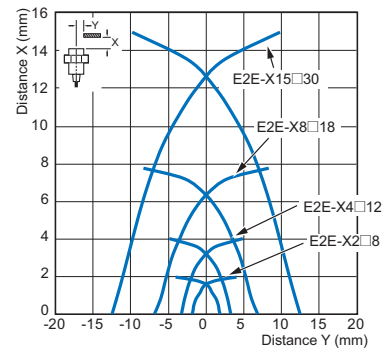

###### Unshielded

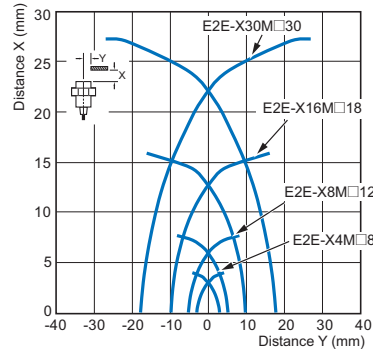

##### Single distance model

###### Shielded

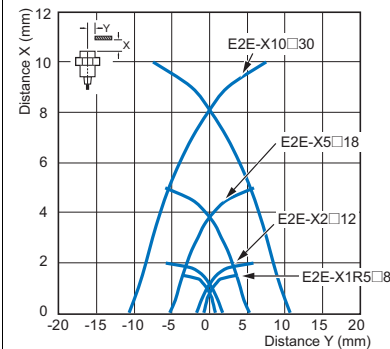

###### Unshielded

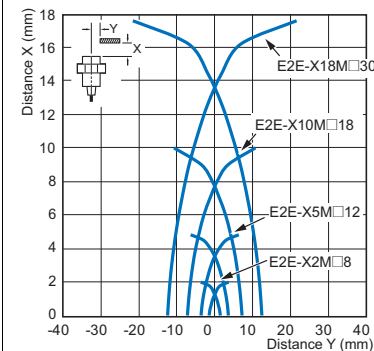



Influence of Sensing Object Size and Material

PREMIUM Model

Shielded

Quadruple distance model

Size: M8 E2E-X4□8

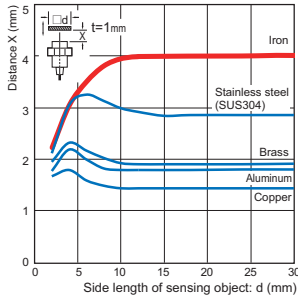

Size: M12 E2E-X9□12

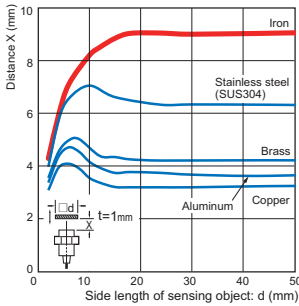

Size: M18 E2E-X14□18

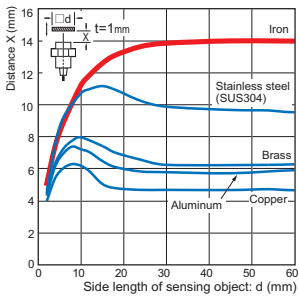

Size: M30 E2E-X23□30

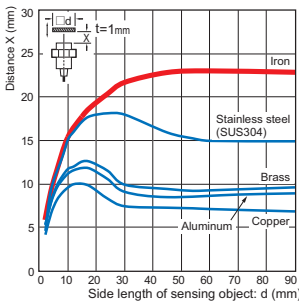

Triple distance model

Size: M8 E2E-X3□8

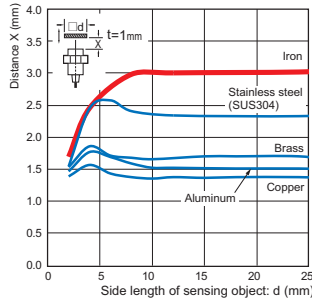

Size: M12 E2E-X6□12

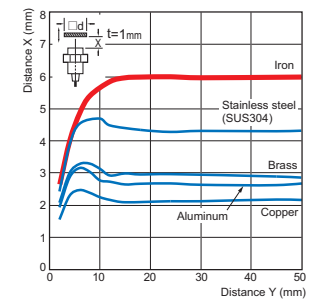

Size: M18 E2E-X12□18

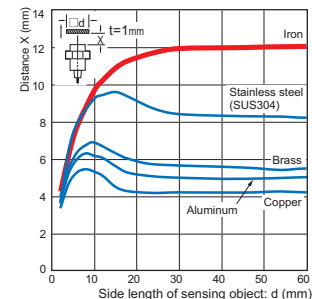

Size: M30 E2E-X22□30

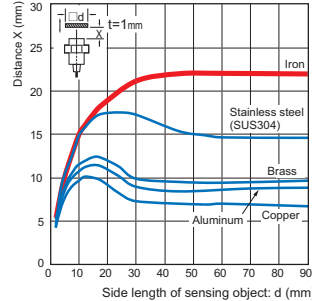

Unshielded

Quadruple distance model

Size: M8 E2E-X8M□8

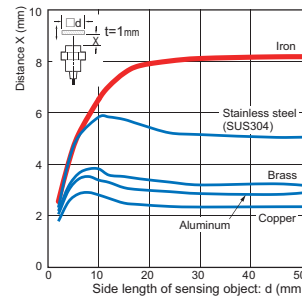

Size: M12 E2E-X16M□12

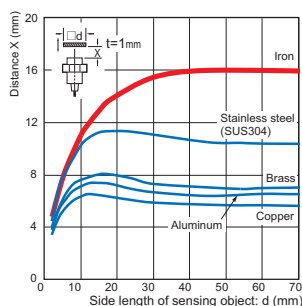

Size: M18 E2E-X30M□18

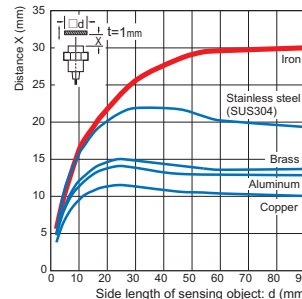

Size: M30 E2E-X50M□30

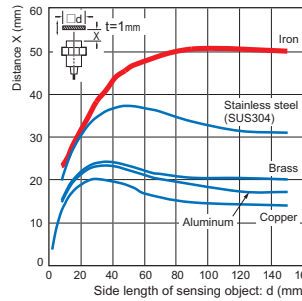

Triple distance model

Size: M8 E2E-X6M□8

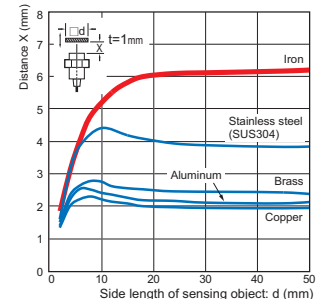

Size: M12 E2E-X10M□12

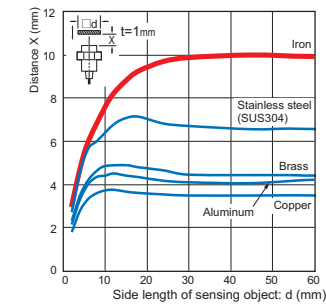

Size: M18 E2E-X20M□18

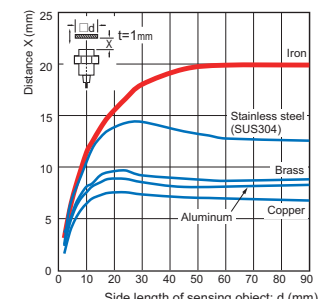

Size: M30 E2E-X40M□30

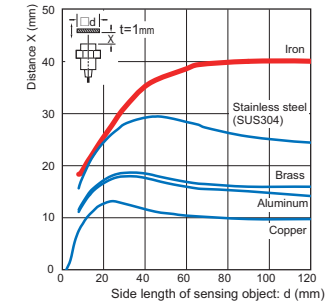

DC 2-wire Triple distance model

Standard/Double/Single distance model

DC 2-wire

DC 3-wire

XS5 NEXT Series

XS5

XS3



Monitor Output vs. Sensing Distance

PREMIUM Model

Shielded

Quadruple distance model

Size: M8 E2E-X4□8

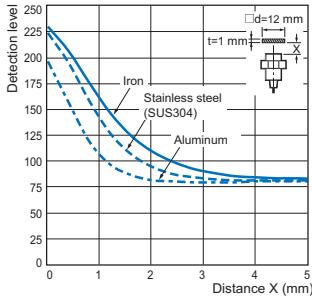

Triple model

Size: M8 E2E-X3□8

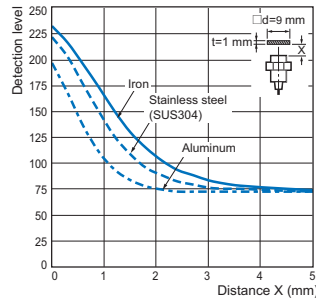

Unshielded

Quadruple distance model

Size: M8 E2E-X8M□8

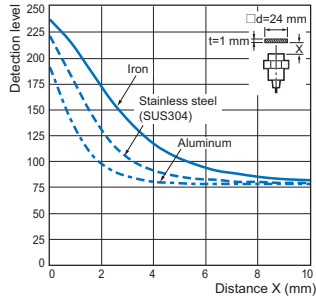

Triple distance model

Size: M8 E2E-X6M□8

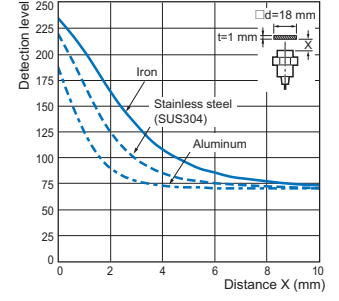

Size: M12 E2E-X9□12

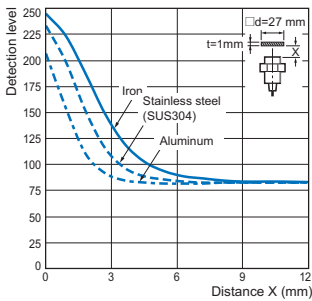

Size: M12 E2E-X6□12

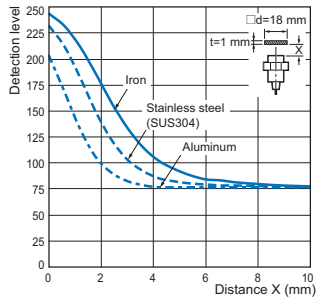

Size: M12 E2E-X16M□12

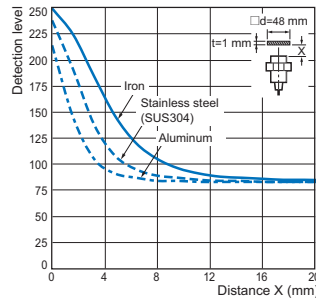

Size: M12 E2E-X10M□12

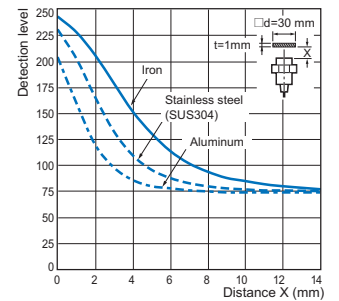

Size: M18 E2E-X14□18

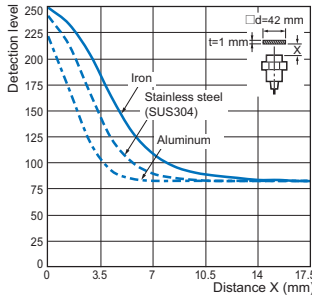

Size: M18 E2E-X12□18

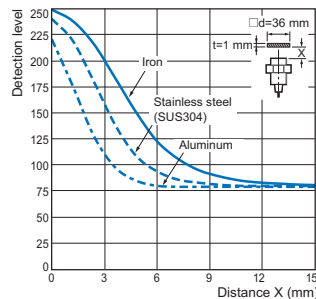

Size: M18 E2E-X30M□18

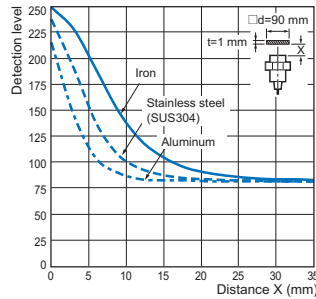

Size: M18 E2E-X20M□18

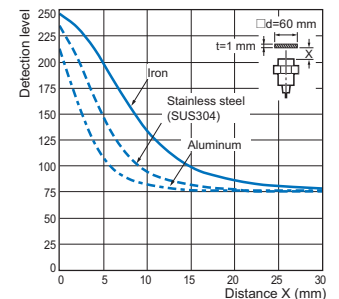

Size: M30 E2E-X23□30

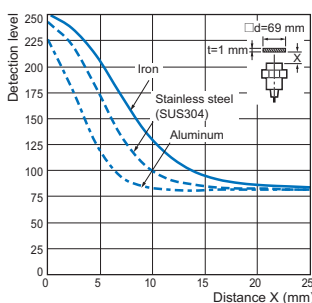

Size: M30 E2E-X22□30

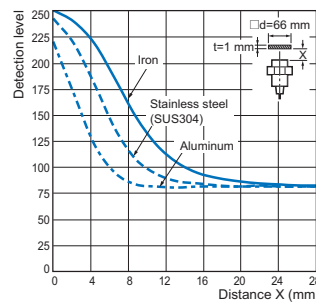

Size: M30 E2E-X50M□30

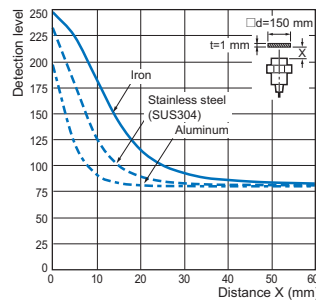

Size: M30 E2E-X40M□30

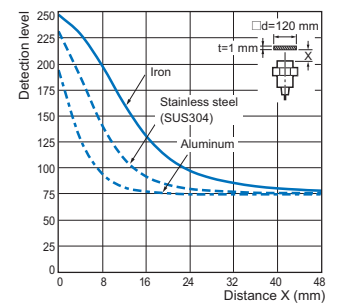

DC 2-wire Triple distance model

DC 2-wire Standard/Double/Single distance model

DC 3-wire

XS5 NEXT Series

XS5

XS3

## BASIC Model

### Shielded

#### Double distance model

Size: M8 E2E-X2□8

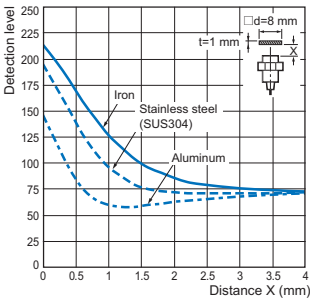

#### Single distance model

Size: M8 E2E-X1R5□8

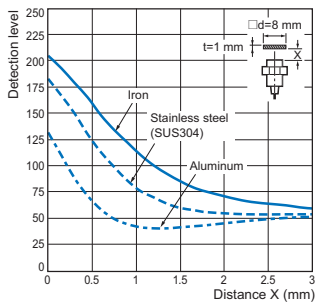

### Unshielded

#### Double distance model

Size: M8 E2E-X4M□8

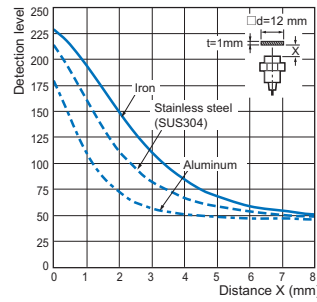

#### Single distance model

Size: M8 E2E-X2M□8

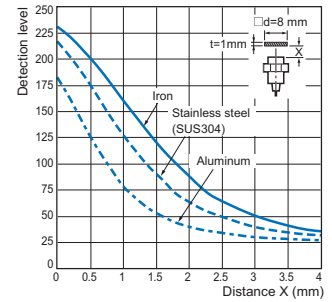

Size: M12 E2E-X4□12

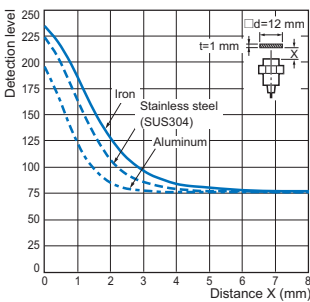

Size: M12 E2E-X2□12

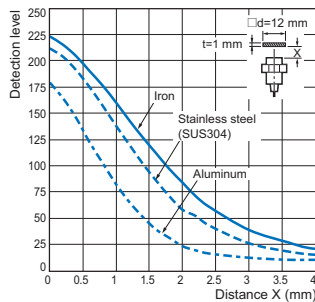

Size: M12 E2E-X8M□12

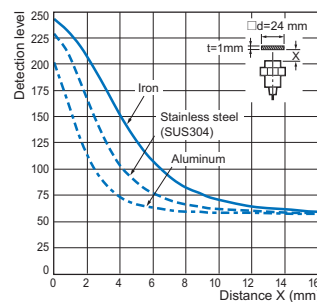

Size: M12 E2E-X5M□12

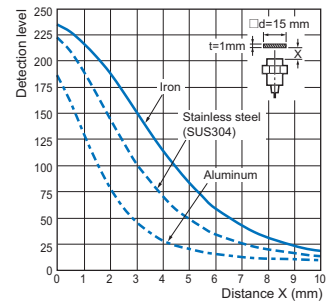

Size: M18 E2E-X8□18

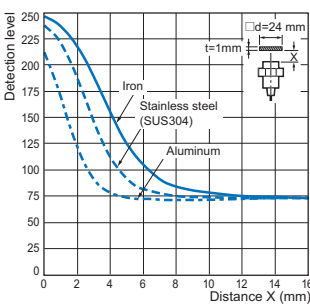

Size: M18 E2E-X5□18

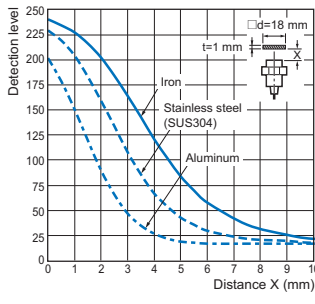

Size: M18 E2E-X16M□18

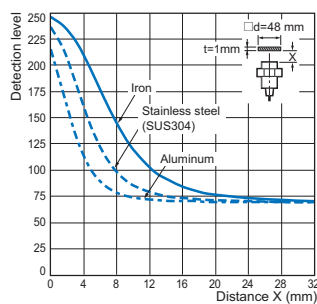

Size: M18 E2E-X10M□18

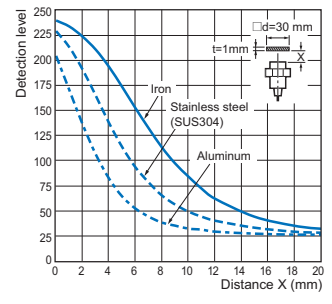

Size: M30 E2E-X15□30

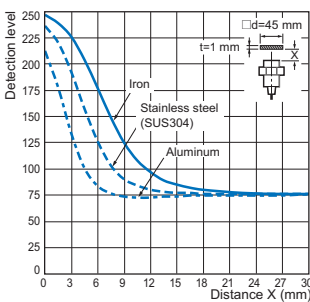

Size: M30 E2E-X10□30

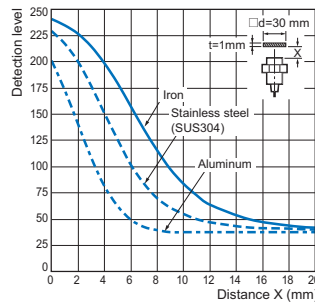

Size: M30 E2E-X30M□30

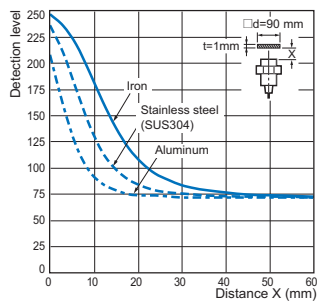

Size: M30 E2E-X18M□30

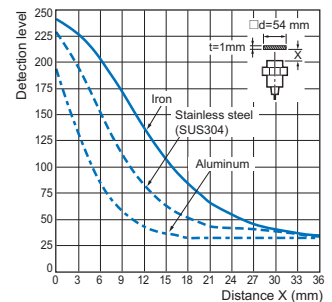

I/O Circuit Diagrams/Timing charts

DC 3-wire  
PNP output

Operation mode	Model	Output circuit	
		Standard I/O mode (SIO mode) When using as a general	IO-Link Communication mode (COM mode) When using the Sensor connected to IO-Link Master Unit *1
NO	E2E-□B1		
NC	E2E-□B2	<p>Note: M8 (3-pin) Connector: (1)(4)(3)</p>	---
NO+NC	E2E-□B3		

\*1. In the IO-Link mode, the cord between the IO-Link master and sensor must have a length of 20 m or less.

\*2. This is the factory setting. For models with IO-Link, the operation mode can be changed by the IO-Link communications.

Connector Pin Arrangement

M12 Connector M12 Smartclick Connector	M8 (4-pin) Connector	M8 (3-pin) Connector

DC 2-wire  
Triple distance model

DC 2-wire  
Standard/Double/Single distance model

DC 3-wire

XS5 NEXT Series

XS5

XS3

## PNP output

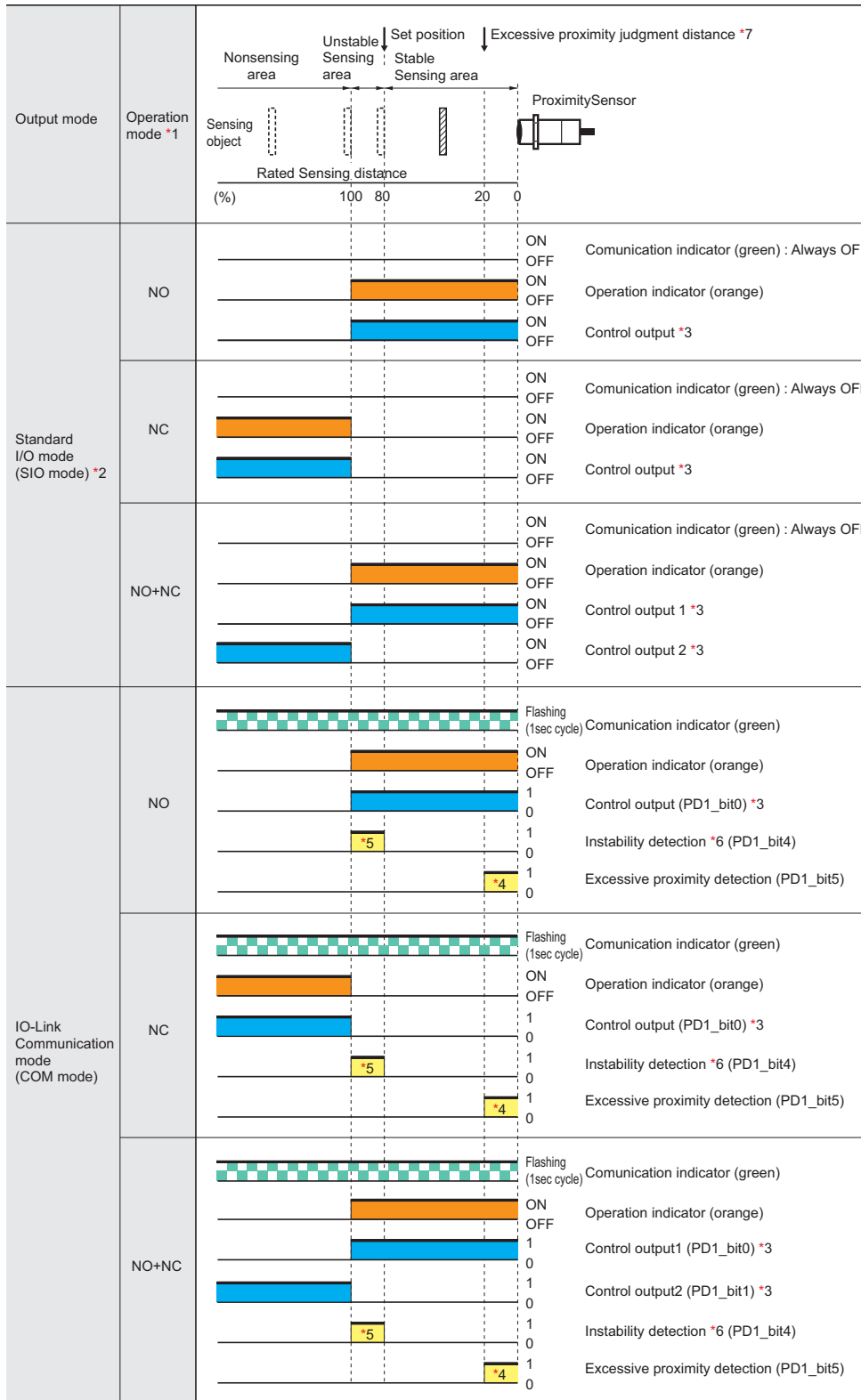

\*3. The timer function of the control output can be set up by the IO-Link communications. (It is able to select ON delay, OFF delay, or one-shot function and select a timer time of 1 to 16,383ms (T).)

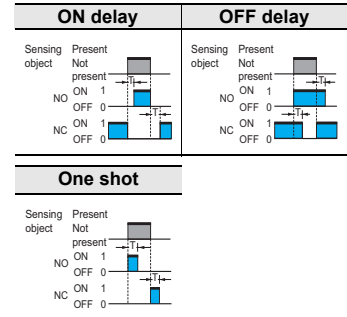

\*4. The excessive proximity diagnosis function can be selected by the IO-Link communications.

\*5. The instability detection diagnosis can be selected by the IO-Link communications.

\*6. The judgment time for the instability detection diagnosis can be selected by the IO-Link communications. (For the ON delay timer function, the setting can be selected from 0 (invalid), 10, 50, 100, 300, 500, or 1000 ms.)

\*7. The judgment distance of the excessive proximity diagnosis function can be selected by the IO-Link communications. (The distance can be selected as a combination of the material of the object detected, such as iron, aluminum, or SUS and the judgment distance of approximately 10, 20, or 30%. However, it is not allowed to select a combination of aluminum and 30%.)

Please contact your OMRON sales representative regarding the IO-Link setup file (IODD file).

Please contact your OMRON sales representative regarding assignment of data.

\*1. This is the factory setting. For models with IO-Link, the operation mode can be changed by the IO-Link communications.

\*2. If using a model with IO-Link as a general sensor or using a model without IO-Link, it operates in the standard I/O mode (SIO mode).

NPN output

Operation mode	Model	Output circuit
NO	E2E-□C1	<p>DC10 to 30V Brown (1) +V Blue (3) 0V Black (4) OUT</p>
NC	E2E-□C2	<p>DC10 to 30V Brown (1) +V Blue (3) 0V Black (2) OUT</p> <p>Note: M8 (3-pin) Connector: (1)(4)(3)</p>
NO+NC	E2E-□C3	<p>DC10 to 30V Brown (1) +V Blue (3) 0V Black (4)(NO) OUT White (2)(NC) OUT2</p>

DC 2-wire  
Triple distance model

DC 2-wire  
Standard/Double/Single distance model

DC 3-wire

Connector Pin Arrangement

M12 Connector M12 Smartclick Connector	M8 (4-pin) Connector	M8 (3-pin) Connector

XS5 NEXT Series

Operation mode	Sensing area		Proximity Sensor	Output	
	Nonsensing area	Stable sensing area		ON/OFF	Output Name
NO				ON OFF	Operation indicator (orange)
NC				ON OFF	Control output
NO+NC				ON OFF ON OFF	Operation indicator (orange) Control output 1 Control output 2

XS5

XS3

## Safety Precautions

Be sure to read the precautions for all models in the website at: <http://www.ia.omron.com/>.

### Warning Indications

<b>⚠ WARNING</b>	<b>Warning level</b> Indicates a potentially hazardous situation which, if not avoided, will result in minor or moderate injury, or may result in serious injury or death. Additionally there may be significant property damage.
<b>Precautions for Safe Use</b>	Supplementary comments on what to do or avoid doing, to use the product safely.
<b>Precautions for Correct Use</b>	Supplementary comments on what to do or avoid doing, to prevent failure to operate, malfunction or undesirable effect on product performance.

### Meaning of Product Safety Symbols

	<b>General prohibition</b> Indicates the instructions of unspecified prohibited action.
	<b>Caution, explosion</b> Indicates the possibility of explosion under specific conditions.

**⚠ WARNING**

**This product is not designed or rated for ensuring safety of persons either directly or indirectly. Do not use it for such purposes.**

---

**Otherwise, explosion may result. Never use the product with an AC power supply.**

### Precautions for Safe Use

The following precautions must be observed to ensure safe operation.

1. Do not use the product in environments subject to flammable or explosive gases.
2. Do not attempt to disassemble, repair, or modify the product.
3. Do not use a voltage that exceeds the rated operating voltage range.  
Applying a voltage that is higher than the operating voltage range may result in explosion or fire.
4. Be sure that the power supply polarity and other wiring is correct. Incorrect wiring may cause explosion or fire.
5. If the power supply is connected directly without a load, the internal elements may explode or burn.
6. Dispose of the product according to applicable regulations (laws).

### Precautions for Correct Use

Do not use the product in any atmosphere or environment that exceeds the ratings.

#### Operating Environment

1. Do not install the Sensor in the following locations.
  - (1) Outdoor locations directly subject to sunlight, rain, snow, water droplets, or oil.
  - (2) Locations subject to atmospheres with chemical vapors, in particular solvents and acids.
  - (3) Locations subject to corrosive gases.
2. The Sensor may malfunction if used near ultrasonic cleaning equipment, high-frequency equipment, transceivers, cellular phones, inverters, or other devices that generate a high-frequency electric field. Please refer to the Precautions for Correct Use on the OMRON website ([www.ia.omron.com](http://www.ia.omron.com)) for typical measures.
3. Laying the Proximity Sensor wiring in the same conduit or duct as high-voltage wires or power lines may result in incorrect operation and damage due to induction. Wire the Sensor using a separate conduit or independent conduit.
4. Never use thinner or other solvents. Otherwise, the Sensor surface may be dissolved.
5. The following conditions shall be observed if you use the product under an environment using cutting oil that may affect product's life and/or performance.
  - Usage under the cutting oil condition designated by the specification
  - Usage under the cutting oil dilution ratio recommended by its manufacturer
  - Usage in oil or water is prohibited
 Impact on the product life may differ depending on the oil you use. Before using the cutting oil, make sure that it should not cause deterioration or degradation of sealing components.
6. When turning on the power by influence of temperature environment, an output mis-pulse sometimes occurs. After the sensor has passed for 300 msec after turning on, please use in the stable state.
7. The sensor is adjusted with a high degree of accuracy, so do not use in the environment with sudden temperature change.
8. Operation check is performed using an OMRON's IO-Link master. If using an IO-Link master from another company, perform the operation check in advance.



**Design**

**Influence of Surrounding Metal**

When mounting the Proximity Sensor using a nut, only use the provided nut. And ensure that the minimum distances given in the following table are maintained.

When mounting the Proximity Sensor using a nut, only use the provided nut. Nuts that are supplied along with each Sensor are different. Refer to Dimensions for details on shapes.

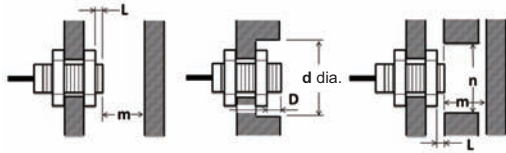

(Unit: mm)

**Shielded**

Type	Model	L	d	D	m	n
Quadruple distance model	E2E-X4□8	3	30	3	12	20
	E2E-X9□12	2	40	2	27	30
	E2E-X14□18	2	60	2	42	70
	E2E-X23□30	2	100	2	69	100
Triple distance model	E2E-X3□8	0	20	0	9	18
	E2E-X6□12	0	20	0	18	20
	E2E-X12□18	0	50	0	36	54
	E2E-X22□30	0	70	0	66	90
Double distance model	E2E-X2□8	0	8	0	4.5	12
	E2E-X4□12	0	18	0	12	18
	E2E-X8□18	0	27	0	24	27
	E2E-X15□30	0	45	0	45	45
Single distance model	E2E-X1R5□8	0	8	0	4.5	12
	E2E-X2□12	0	12	0	8	18
	E2E-X5□18	0	18	0	20	27
	E2E-X10□30	0	30	0	40	45

**Unshielded**

Models	Model	L	d	D	m	n
Quadruple distance model	E2E-X8M□8	12	40	12	24	40
	E2E-X16M□12	21	70	21	48	80
	E2E-X30M□18	46	130	46	90	110
	E2E-X50M□30	60	200	60	150	180
Triple distance model	E2E-X6M□8	10	30	10	18	30
	E2E-X10M□12	16	50	16	30	50
	E2E-X20M□18	31	90	31	60	80
	E2E-X40M□30 *	50	170	50	120	140
Double distance model	E2E-X4M□8	9	24	9	8	24
	E2E-X8M□12	11	40	11	20	40
	E2E-X16M□18	21	70	21	48	70
	E2E-X30M□30	40	120	40	90	120
Single distance model	E2E-X2M□8	6	24	6	8	24
	E2E-X5M□12	11	40	11	20	36
	E2E-X10M□18	18	55	18	40	54
	E2E-X18M□30	25	90	25	70	90

\* If you use the model E2E-X40M□30, the panel thickness (t) is 4 mm or less.

When the Proximity Sensor is mounted in metal, ensure that the minimum distances given in the following table are maintained.

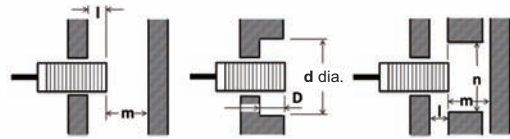

(Unit: mm)

**Shielded**

Models	Model	l	d	D	m	n
Quadruple distance model	E2E-X4□8	4	30	4	12	20
	E2E-X9□12	6	40	6	27	30
	E2E-X14□18	7	60	7	42	70
	E2E-X23□30	9	100	9	69	100
Triple distance model	E2E-X3□8	2	20	2	9	18
	E2E-X6□12	4	20	4	18	20
	E2E-X12□18	4	50	4	36	54
	E2E-X22□30	8	70	8	66	90
Double distance model	E2E-X2□8	0	8	0	4.5	12
	E2E-X4□12	2.4	18	2.4	12	18
	E2E-X8□18	3.6	27	3.6	24	27
	E2E-X15□30	6	45	6	45	45
Single distance model	E2E-X1R5□8	0	8	0	4.5	12
	E2E-X2□12	0	12	0	8	18
	E2E-X5□18	0	18	0	20	27
	E2E-X10□30	0	30	0	40	45

**Unshielded**

Models	Model	l	d	D	m	n
Quadruple distance model	E2E-X8M□8	15	40	15	24	40
	E2E-X16M□12	25	70	25	48	80
	E2E-X30M□18	50	130	50	90	110
	E2E-X50M□30	65	200	65	150	180
Triple distance model	E2E-X6M□8	13	30	13	18	30
	E2E-X10M□12	20	50	20	30	50
	E2E-X20M□18	35	90	35	60	80
	E2E-X40M□30 *	55	170	55	120	140
Double distance model	E2E-X4M□8	12	24	12	8	24
	E2E-X8M□12	15	40	15	20	40
	E2E-X16M□18	25	70	25	48	70
	E2E-X30M□30	45	120	45	90	120
Single distance model	E2E-X2M□8	6	24	6	8	24
	E2E-X5M□12	15	40	15	20	36
	E2E-X10M□18	22	55	22	40	54
	E2E-X18M□30	30	90	30	70	90

\* If you use the model E2E-X40M□30, the panel thickness (t) is 4 mm or less.

## Mutual Interference

When installing two or more Proximity Sensors face-to-face or side-by-side, ensure that the minimum distances given in the following table are maintained.

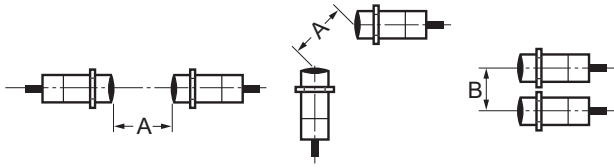

(Unit: mm)

### Shielded

Models	Model	Item	
		A	B
Quadruple distance model	E2E-X4□8	40	20
	E2E-X9□12	60	35
	E2E-X14□18	90	50
	E2E-X23□30	150	90
Triple distance model	E2E-X3□8	25	20
	E2E-X6□12	40	30
	E2E-X12□18	70	45
	E2E-X22□30	150	90
Double distance model	E2E-X2□8	20	15
	E2E-X4□12	30	20
	E2E-X8□18	60	35
Single distance model	E2E-X15□30	110	90
	E2E-X1R5□8	20	15
	E2E-X2□12	30	20
	E2E-X5□18	50	35
	E2E-X10□30	100	70

### Unshielded

Models	Model	Item	
		A	B
Quadruple distance model	E2E-X8M□8	80	60
	E2E-X16M□12	160	120
	E2E-X30M□18	360	300
	E2E-X50M□30	700	480
Triple distance model	E2E-X6M□8	80	60
	E2E-X10M□12	120	100
	E2E-X20M□18	200	120
	E2E-X40M□30	380	300
Double distance model	E2E-X4M□8	80	60
	E2E-X8M□12	120	100
	E2E-X16M□18	200	120
	E2E-X30M□30	350	300
Single distance model	E2E-X2M□8	80	60
	E2E-X5M□12	120	100
	E2E-X10M□18	200	110
	E2E-X18M□30	300	200

## Mounting

### Tightening Force

Do not tighten the sensor mounting nuts with excessive force. Secure the mounting nuts to the corresponding torque values in the following table.

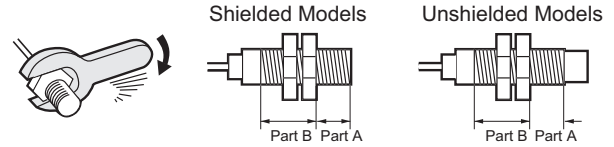

- Note:** 1. The allowable tightening strength depends on the distance from the edge of the head, as shown in the following table. (A is the distance from the edge of the head. B includes the nut on the head side. If the edge of the nut is in part A, the tightening torque for part A applies instead.)  
2. The following strengths assume washers are being used.

### Quadruple distance model, Triple distance model, Spatter-resistant Triple distance model

Size	Shielded	Part A		Part B
		Dimension (mm)	Torque	Torque
M8	Shielded	9	4 N·m	10 N·m
	Unshielded	3		
M12	Shielded	16	8 N·m	15 N·m
	Unshielded	9	6 N·m	
M18	Shielded	16	15 N·m	60 N·m
	Unshielded	3		
M30	Shielded	23	40 N·m	80 N·m
	Unshielded	8		

### Double distance model, Single distance model, Spatter-resistant Triple distance model, Spatter-resistant Single distance model

Size	Shielded	Part A		Part B
		Dimension (mm)	Torque	Torque
M8	Shielded	9	9 N·m	12 N·m
	Unshielded	3		
M12	---	---	30 N·m	
M18	---	---	70 N·m	
M30	---	---	180 N·m	

## Dimensions

### Sensor PREMIUM Model

#### DC 3-wire (Quadruple/Triple distance model)

Pre-wired Models  
Pre-wired Connector Models  
(Shielded)



Note: Refer to the figure below the table for the connections of the Pre-wired Connector Model.

#### DC 3-wire (Long-body Quadruple/Triple distance model)

Pre-wired Models  
Pre-wired Connector Models  
(Shielded)



Note: Refer to the figure below the table for the connections of the Pre-wired Connector Model.

#### E2E-X□8

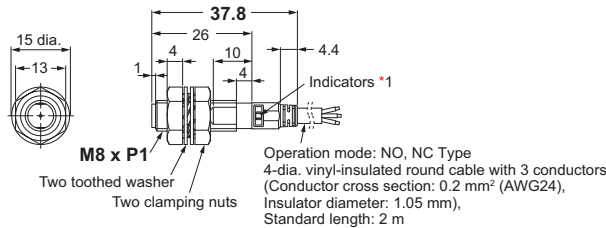

#### E2E-X□L8

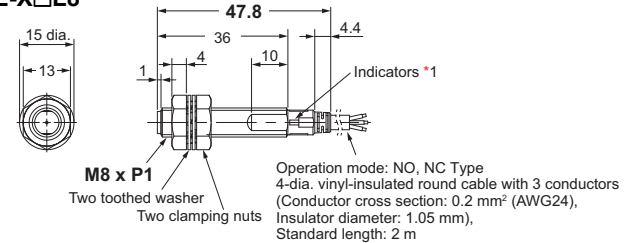

#### E2E-X□12

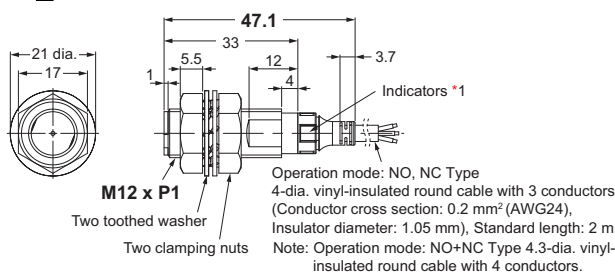

#### E2E-X□L12

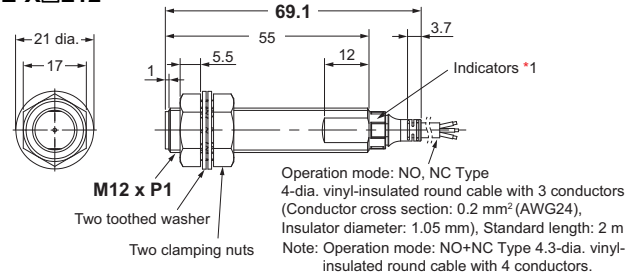

#### E2E-X□18

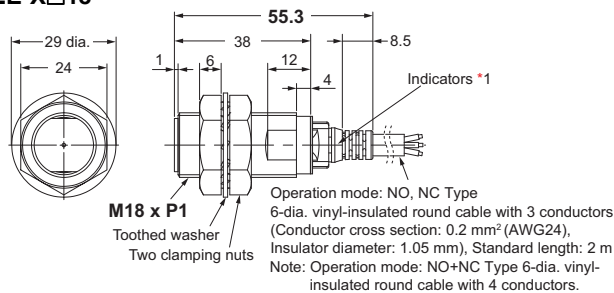

#### E2E-X□L18

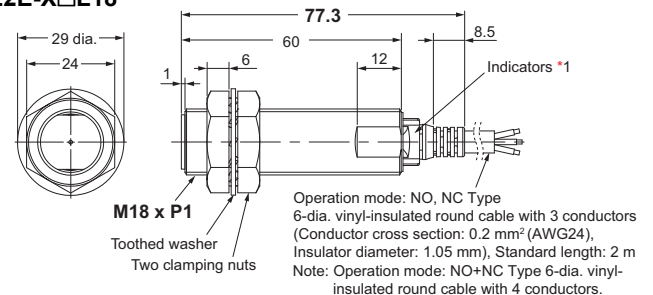

#### E2E-X□30

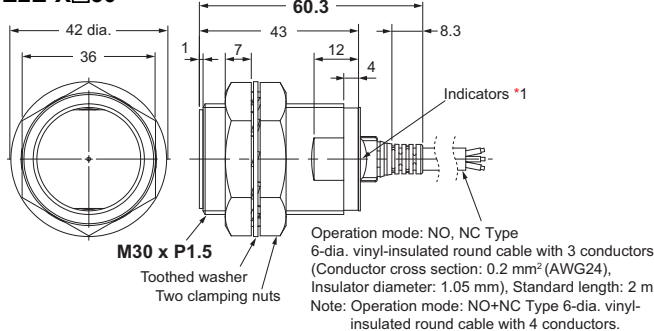

#### E2E-X□L30

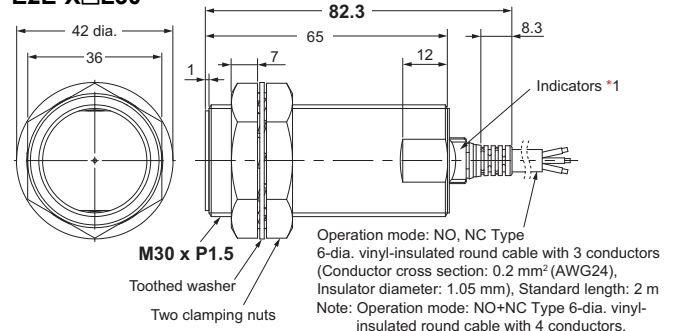

\*1. Standard I/O mode (SIO mode): Operation indicator (orange/ON), communication indicator (green/OFF)  
IO-Link Communication mode (COM mode): Operation indicator (orange/ON), communication indicator (green/Flashing (1sec cycle))

#### Pre-wired Connector Models (-M1TJ)

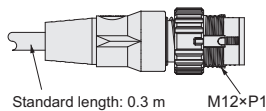

Note: Refer to the Pre-wired Model for the cable specifications of the Pre-wired Connector Model.

#### Mounting Hole Dimensions



Dimensions	F (mm)
M8	8.5 dia. $^{+0.5}_0$
M12	12.5 dia. $^{+0.5}_0$
M18	18.5 dia. $^{+0.5}_0$
M30	30.5 dia. $^{+0.5}_0$

#### Angle R of the Bending Wire

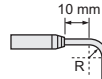

Dimensions	R (mm)
M8	12
M12	12
M18	18
M30	18

#### Wire pullout position



Dimensions	Sc (mm)
M8	- (0)
M12	- (0)
M18	- (0)
M30	2.5

# E2E NEXT Series

## Sensors PREMIUM Model

### DC 3-wire (Quadruple/Triple distance model)

#### Pre-wired Models

#### Pre-wired Connector Models (Unshielded)



**Note:**  
Refer to the figure below the table for the connections of the Pre-wired Connector Model.

#### E2E-X□M□8

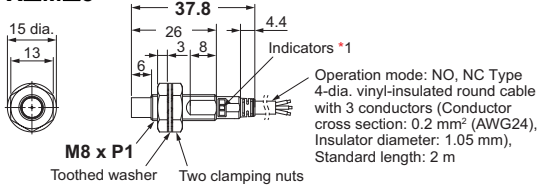

#### E2E-X□M□12

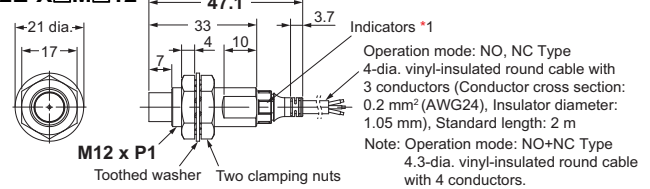

### DC 3-wire (Long-body Quadruple/Triple distance model)

#### Pre-wired Models

#### Pre-wired Connector Models (Unshielded)



**Note:**  
Refer to the figure below the table for the connections of the Pre-wired Connector Model.

#### E2E-X□M□L8

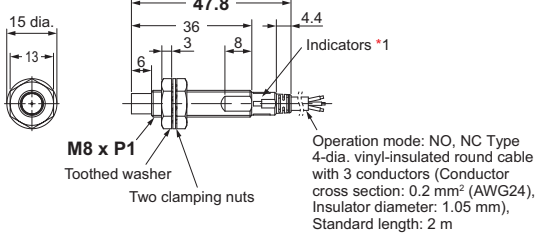

#### E2E-X□M□L12

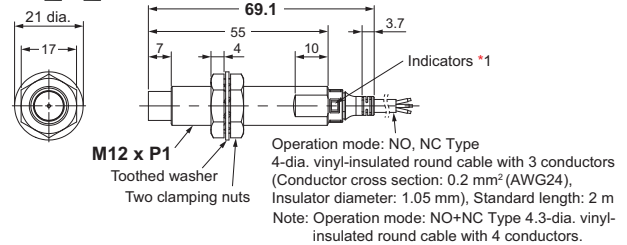

#### E2E-X□M□L18

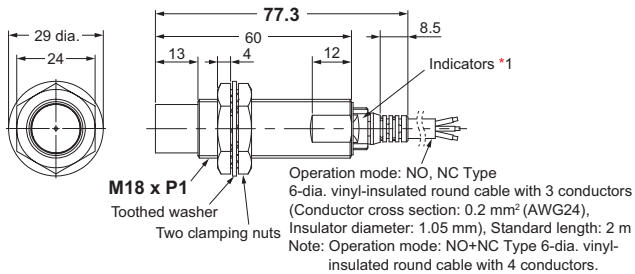

#### E2E-X40M□L30

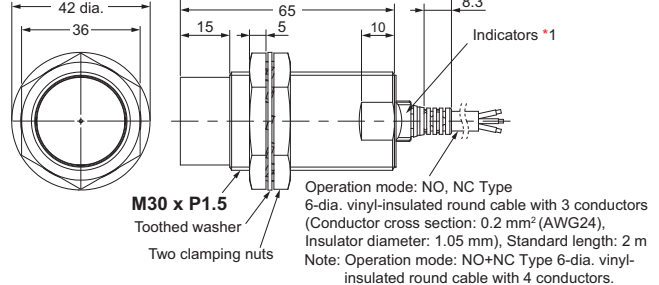

#### E2E-X50M□L30

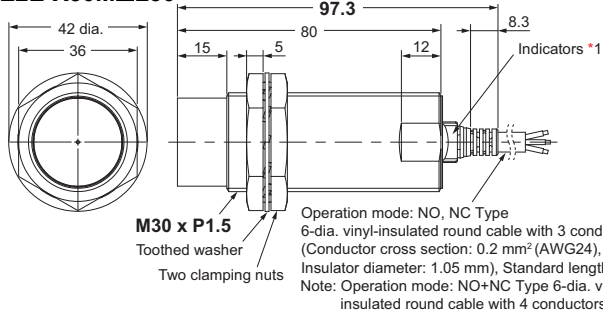

\*1. Standard I/O mode (SIO mode): Operation indicator (orange/ON), communication indicator (green/OFF)  
IO-Link Communication mode (COM mode): Operation indicator (orange/ON), communication indicator (green/Flashing (1sec cycle))

#### Pre-wired Connector Models (-M1TJ)

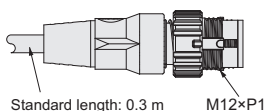

**Note:** Refer to the Pre-wired Model for the cable specifications of the Pre-wired Connector Model.

#### Mounting Hole Dimensions



Dimensions	F (mm)
M8	8.5 dia. <sup>+0.5</sup> / <sub>0</sub>
M12	12.5 dia. <sup>+0.5</sup> / <sub>0</sub>
M18	18.5 dia. <sup>+0.5</sup> / <sub>0</sub>
M30	30.5 dia. <sup>+0.5</sup> / <sub>0</sub>

#### Angle R of the Bending Wire

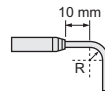

Dimensions	R (mm)
M8	12
M12	12
M18	18
M30	18

#### Wire pullout position



Dimensions	Sc (mm)
M8	- (0)
M12	- (0)
M18	2.5
M30	2.5

**Sensors** PREMIUM Model

**DC 3-wire (Quadruple/Triple distance model)**  
**Connector Models**  
**(Shielded)**



**DC 3-wire (Long-body Quadruple/Triple distance model)**  
**Connector Models**  
**(Shielded)**



**E2E-X□8-M3/M5**

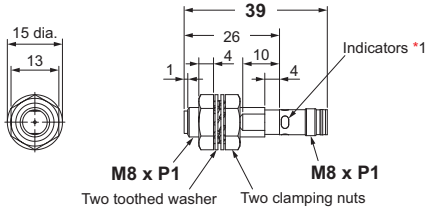

**E2E-X□L8-M3/M5**

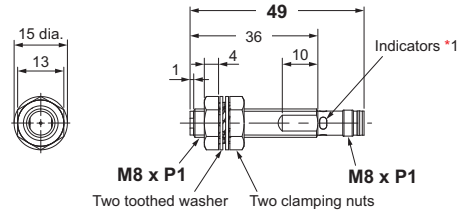

**E2E-X□8-M1**

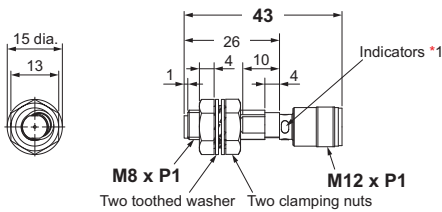

**E2E-X□L8-M1**

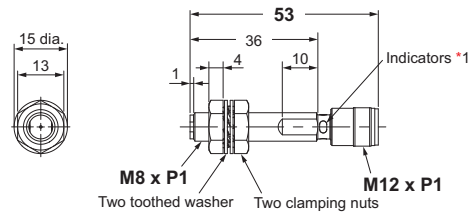

**E2E-X□12-M1**

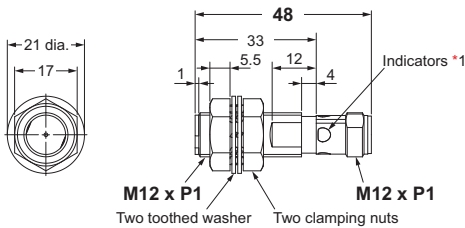

**E2E-X□L12-M1**

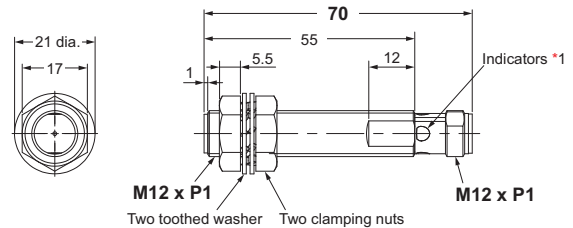

**E2E-X□18-M1**

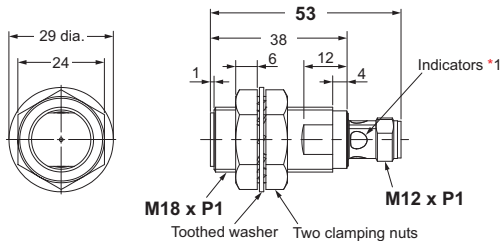

**E2E-X□L18-M1**

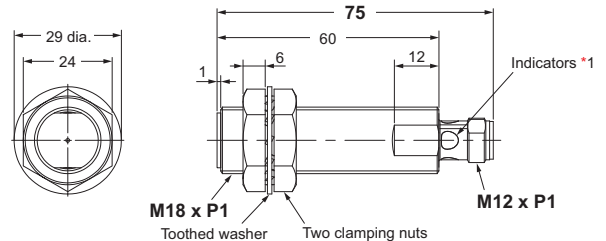

**E2E-X□30-M1**

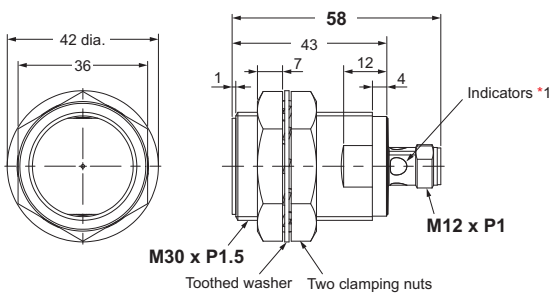

**E2E-X□L30-M1**

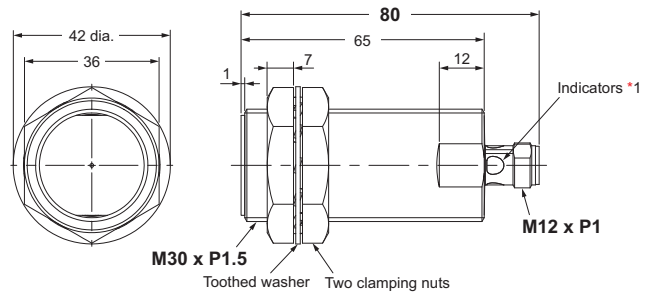

\*1. Standard I/O mode (SIO mode): Operation indicator (orange/ON), communication indicator (green/OFF)  
 IO-Link Communication mode (COM mode): Operation indicator (orange/ON), communication indicator (green/Flashing (1sec cycle))

**Mounting Hole Dimensions**



Dimensions	F (mm)
<b>M8</b>	8.5 dia. $^{+0.5}_0$
<b>M12</b>	12.5 dia. $^{+0.5}_0$
<b>M18</b>	18.5 dia. $^{+0.5}_0$
<b>M30</b>	30.5 dia. $^{+0.5}_0$

DC 2-wire Triple distance model

Standard/Double/Single distance model

DC 3-wire

XS5 NEXT Series

XS5

XS3

# E2E NEXT Series

## Sensors PREMIUM Model

### DC 3-wire (Quadruple/Triple distance model)

Connector Models  
(Unshielded)



### DC 3-wire (Long-body Quadruple/Triple distance model)

Connector Models  
(Unshielded)



#### E2E-X□M□8-M3/M5

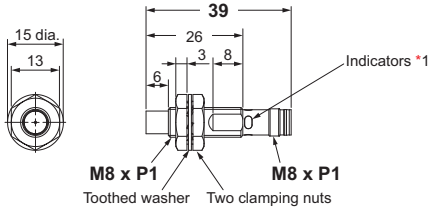

#### E2E-X□M□L8-M3/M5

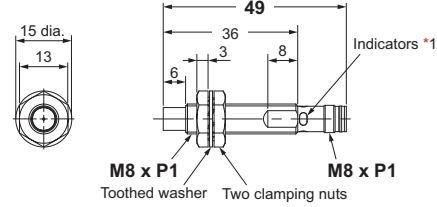

#### E2E-X□M□8-M1

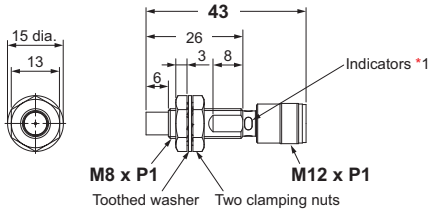

#### E2E-X□M□L8-M1

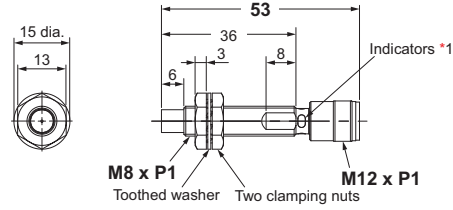

#### E2E-X□M□12-M1

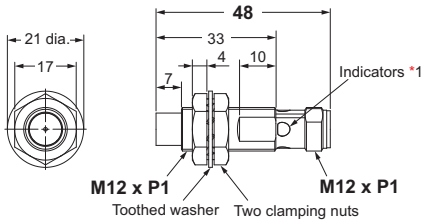

#### E2E-X□M□L12-M1

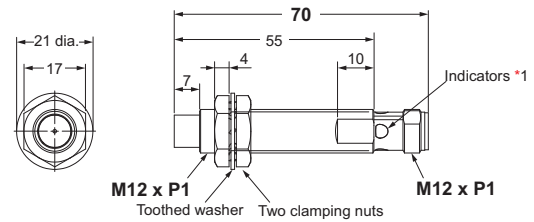

\*1. Standard I/O mode (SIO mode): Operation indicator (orange/ON), communication indicator (green/OFF)  
IO-Link Communication mode (COM mode): Operation indicator (orange/ON), communication indicator (green/Flashing (1sec cycle))

#### Mounting Hole Dimensions



Dimensions	F (mm)
M8	8.5 dia. $^{+0.5}_0$
M12	12.5 dia. $^{+0.5}_0$
M18	18.5 dia. $^{+0.5}_0$
M30	30.5 dia. $^{+0.5}_0$

#### E2E-X□M□L18-M1

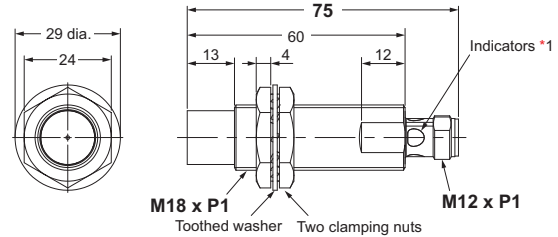

#### E2E-X40M□L30-M1

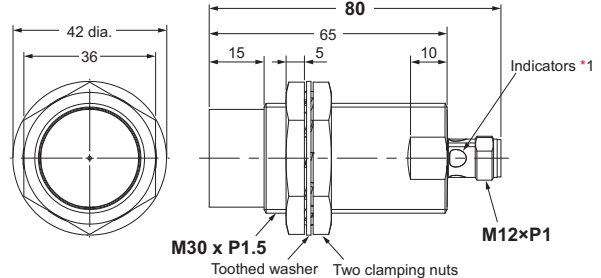

#### E2E-X50M□L30-M1

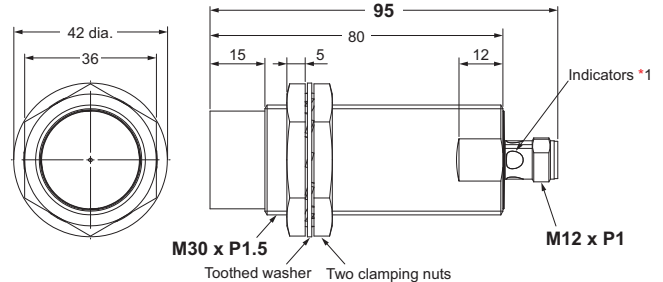

**Sensors** BASIC Model

**DC 3-wire (Double/Single distance model)**  
**Pre-wired Models**  
**Pre-wired Connector Models**  
**(Shielded)**



**Note:** Refer to the figure below the table for the connections of the Pre-wired Connector Model.

**DC 3-wire (Long-body Double/Single distance model)**  
**Pre-wired Models**  
**Pre-wired Connector Models**  
**(Shielded)**



**Note:** Refer to the figure below the table for the connections of the Pre-wired Connector Model.

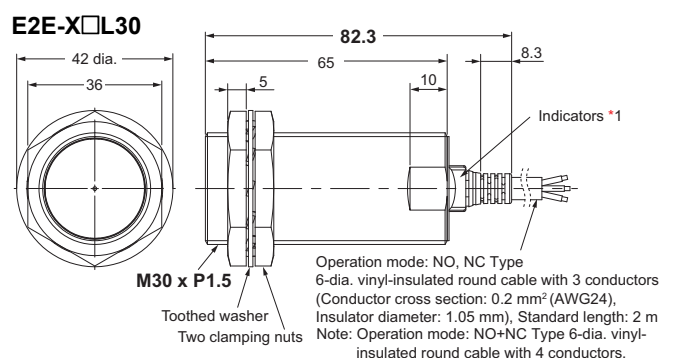
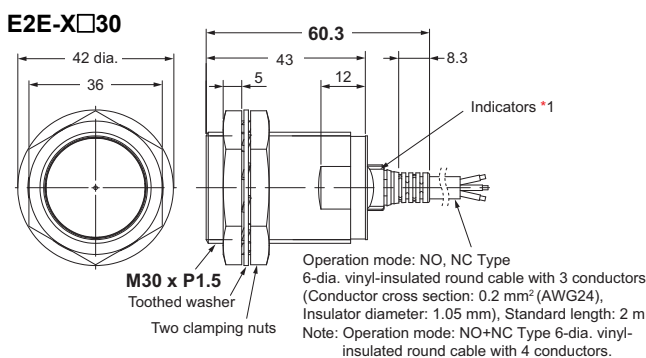
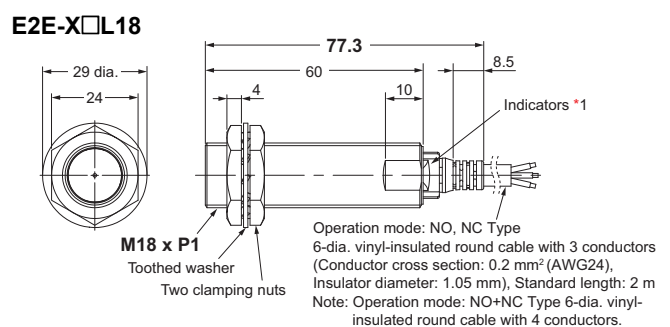
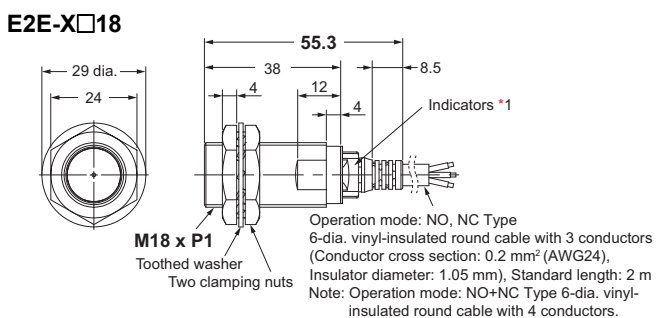
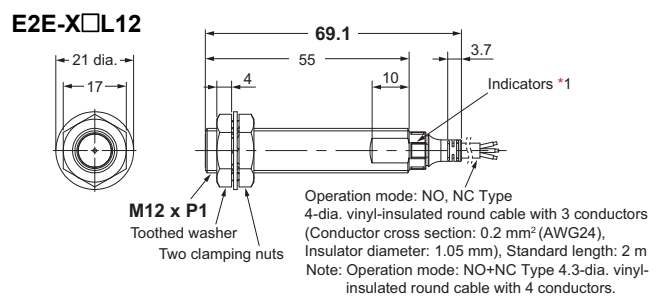
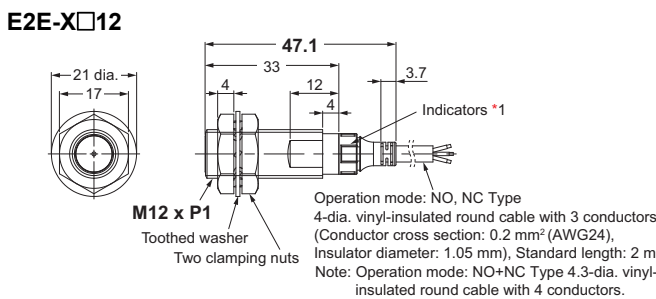
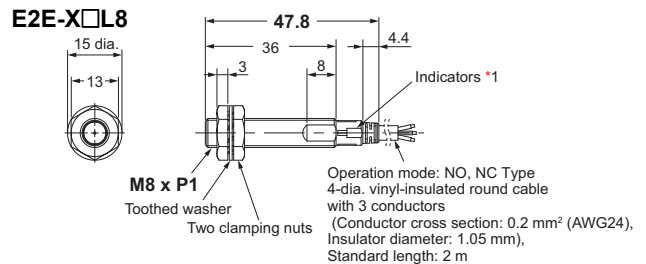
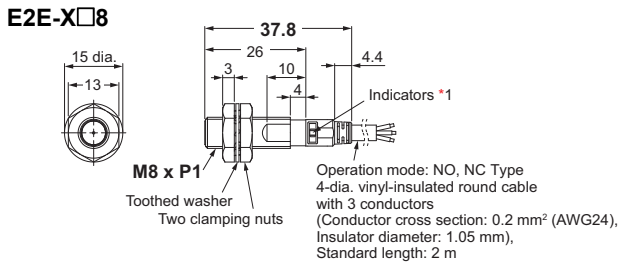

\*1. Standard I/O mode (SIO mode): Operation indicator (orange/ON), communication indicator (green/OFF)  
 IO-Link Communication mode (COM mode): Operation indicator (orange/ON), communication indicator (green/Flashing (1sec cycle))

**Pre-wired Connector Models (-M1TJ)**

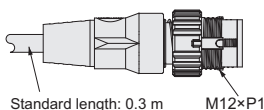

**Note:** Refer to the Pre-wired Model for the cable specifications of the Pre-wired Connector Model.

**Mounting Hole Dimensions**



Dimensions	F (mm)
M8	8.5 dia. <sup>+0.5</sup> / <sub>0</sub>
M12	12.5 dia. <sup>+0.5</sup> / <sub>0</sub>
M18	18.5 dia. <sup>+0.5</sup> / <sub>0</sub>
M30	30.5 dia. <sup>+0.5</sup> / <sub>0</sub>

**Angle R of the Bending Wire**

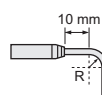

Dimensions	R (mm)
M8	12
M12	12
M18	18
M30	18

**Wire pullout position**



Dimensions	Sc (mm)
M8	-(0)
M12	-(0)
M18	2.5
M30	2.5

# E2E NEXT Series

## Sensors **BASIC Model**

### DC 3-wire (Double/Single distance model)

**Pre-wired Models**  
**Pre-wired Connector Models**  
**(Unshielded)**



**Note:**  
Refer to the figure below the table for the connections of the Pre-wired Connector Model.

### DC 3-wire (Long-body Double/Single distance model)

**Pre-wired Models**  
**Pre-wired Connector Models**  
**(Unshielded)**



**Note:**  
Refer to the figure below the table for the connections of the Pre-wired Connector Model.

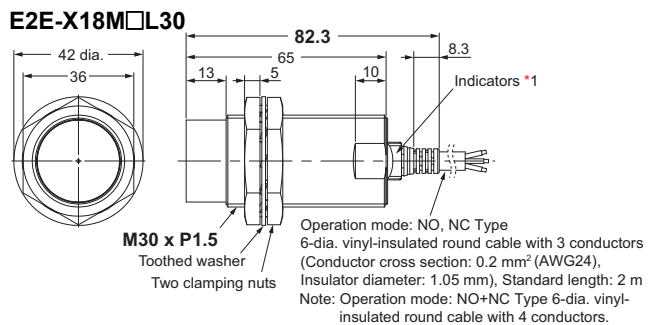
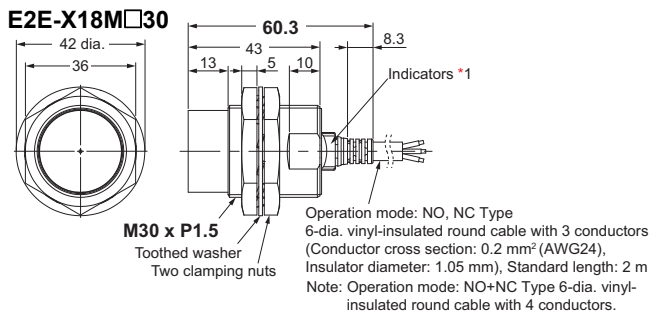
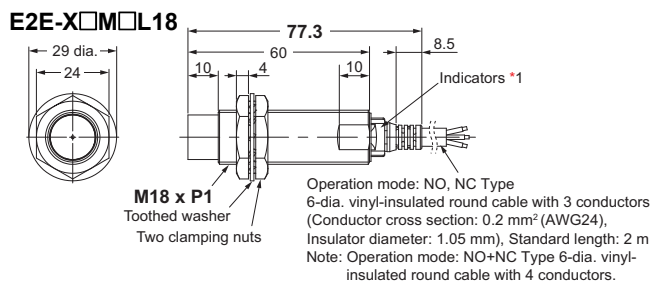
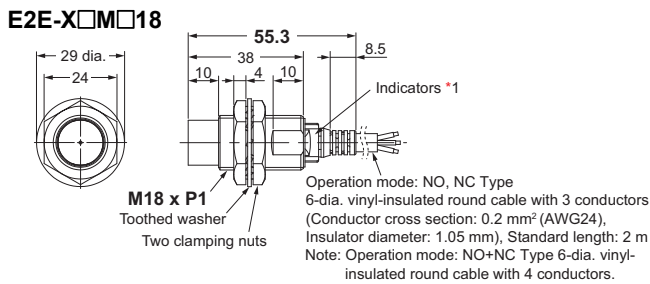
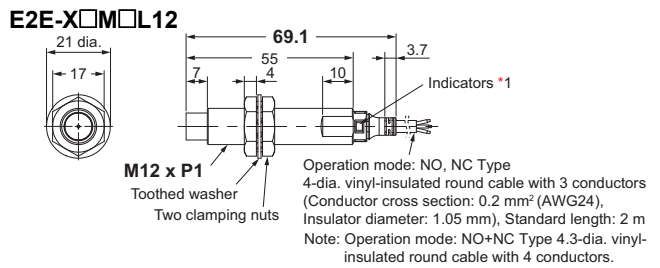
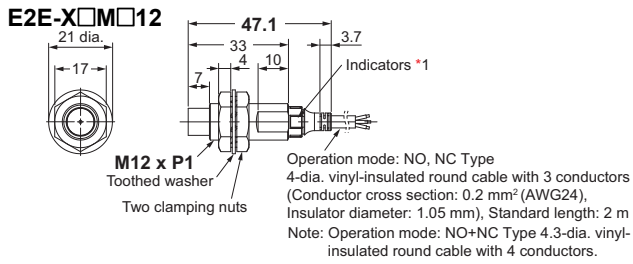
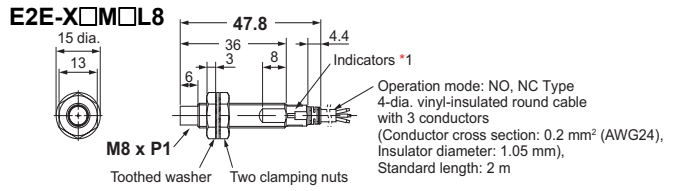
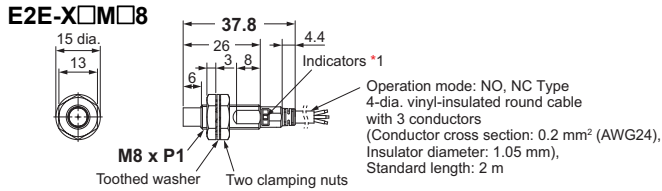

\*1. Standard I/O mode (SIO mode): Operation indicator (orange/ON), communication indicator (green/OFF)  
IO-Link Communication mode (COM mode): Operation indicator (orange/ON), communication indicator (green/Flashing (1sec cycle))

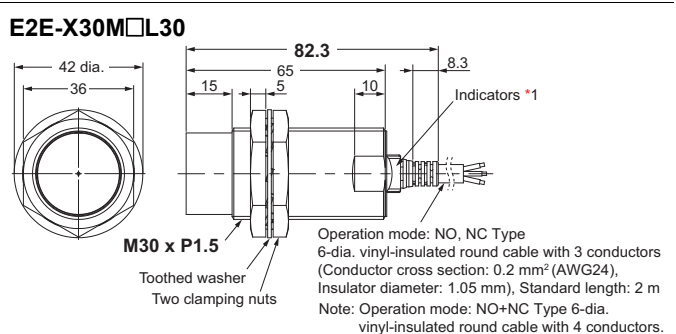

### Pre-wired Connector Models (-M1TJ)

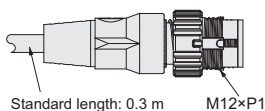

**Note:** Refer to the Pre-wired Model for the cable specifications of the Pre-wired Connector Model.

### Mounting Hole Dimensions



Dimensions	F (mm)
M8	8.5 dia. <sup>+0.5</sup> / <sub>0</sub>
M12	12.5 dia. <sup>+0.5</sup> / <sub>0</sub>
M18	18.5 dia. <sup>+0.5</sup> / <sub>0</sub>
M30	30.5 dia. <sup>+0.5</sup> / <sub>0</sub>

### Angle R of the Bending Wire

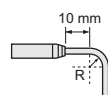

Dimensions	R (mm)
M8	10
M12	12
M18	18
M30	18

### Wire pullout position



Dimensions	Sc (mm)
M8	- (0)
M12	- (0)
M18	2.5
M30	2.5



**Sensors** BASIC Model

**DC 3-wire (Double/Single distance model)**  
**Connector Models (Shielded)**



**DC 3-wire (Long-body Double/Single distance model)**  
**Connector Models (Shielded)**



**E2E-X□8-M3/M5**

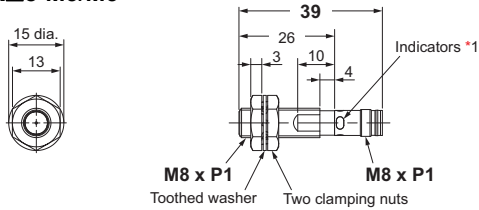

**E2E-X□L8-M3/M5**

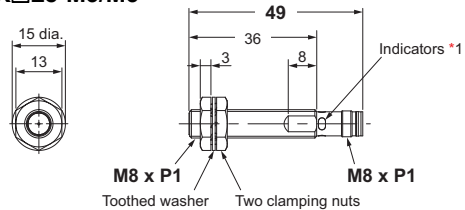

**E2E-X□8-M1**

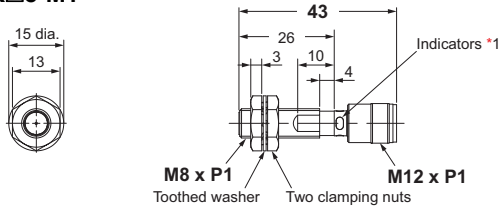

**E2E-X□L8-M1**

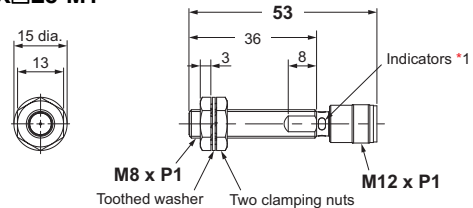

**E2E-X□12-M1**

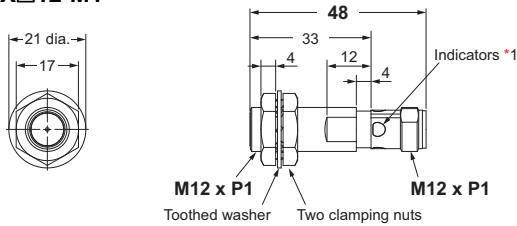

**E2E-X□L12-M1**

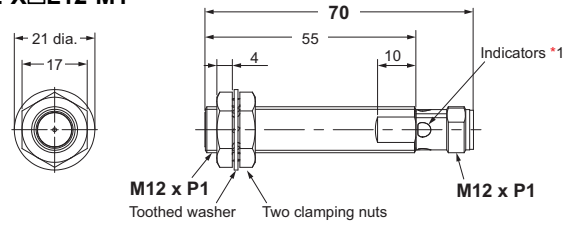

**E2E-X□18-M1**

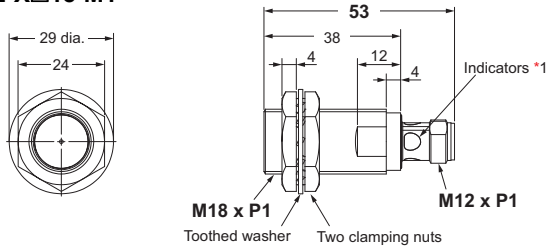

**E2E-X□L18-M1**

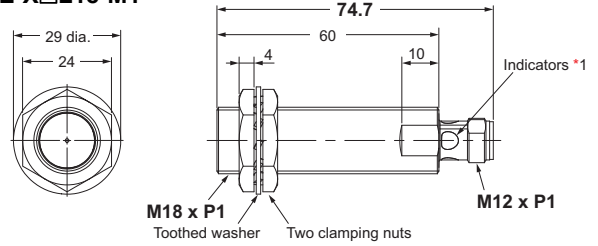

**E2E-X□30-M1**

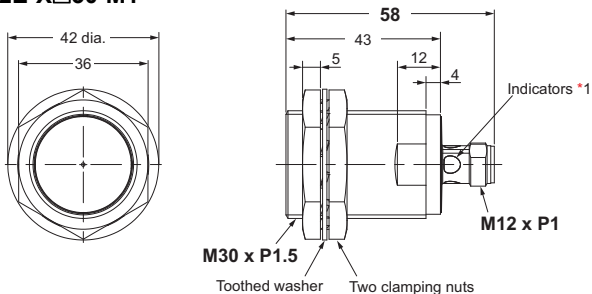

**E2E-X□L30-M1**

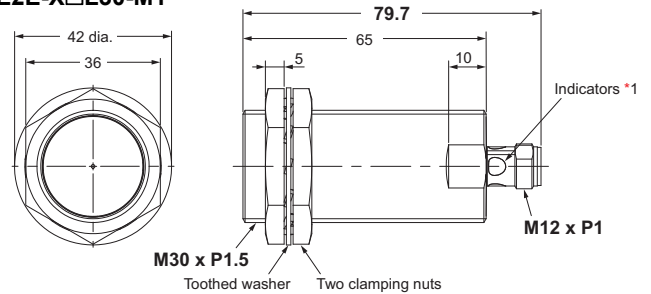

\*1. Standard I/O mode (SIO mode): Operation indicator (orange/ON), communication indicator (green/OFF)  
 IO-Link Communication mode (COM mode): Operation indicator (orange/ON), communication indicator (green/Flashing (1sec cycle))

**Mounting Hole Dimensions**



Dimensions	F (mm)
<b>M8</b>	8.5 dia. <sup>+0.5</sup> / <sub>0</sub>
<b>M12</b>	12.5 dia. <sup>+0.5</sup> / <sub>0</sub>
<b>M18</b>	18.5 dia. <sup>+0.5</sup> / <sub>0</sub>
<b>M30</b>	30.5 dia. <sup>+0.5</sup> / <sub>0</sub>

DC 2-wire Triple distance model  
 DC 2-wire Standard/Double/Single distance model  
 DC 3-wire  
 XS5 NEXT Series  
 XS5  
 XS3

# E2E NEXT Series

## Sensors **BASIC Model**

### DC 3-wire (Double/Single distance model)

#### Connector Models (Unshielded)



Note: The sensing surface of size M30 is light gray.

### DC 3-wire (Long-body Double/Single distance model)

#### Connector Models (Unshielded)



Note: The sensing surface of size M30 is light gray.

#### E2E-X□M□8-M3/M5

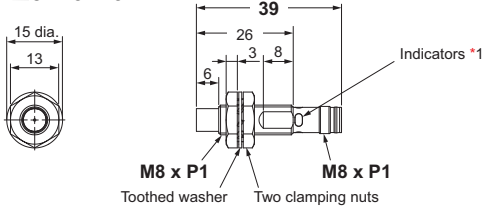

#### E2E-X□M□L8-M3/M5

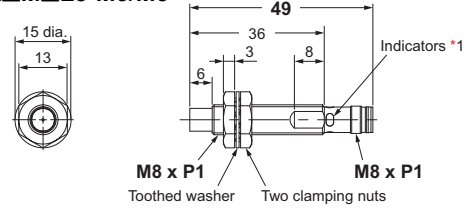

#### E2E-X□M□8-M1

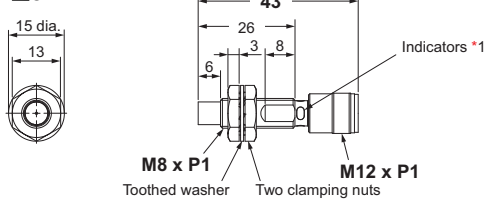

#### E2E-X□M□L8-M1

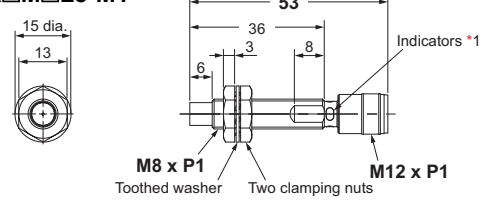

#### E2E-X□M□12-M1

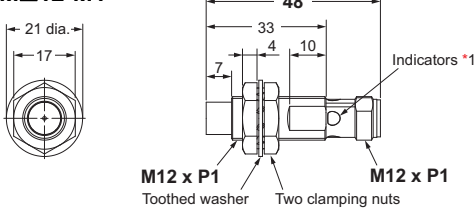

#### E2E-X□M□L12-M1

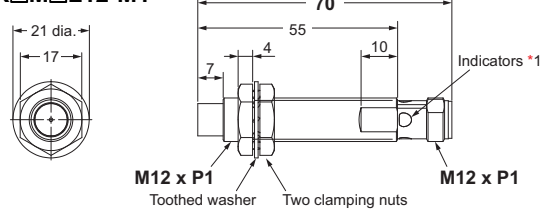

#### E2E-X□M□18-M1

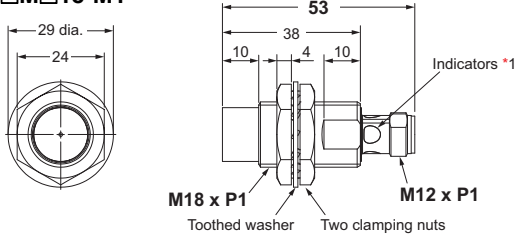

#### E2E-X□M□L18-M1

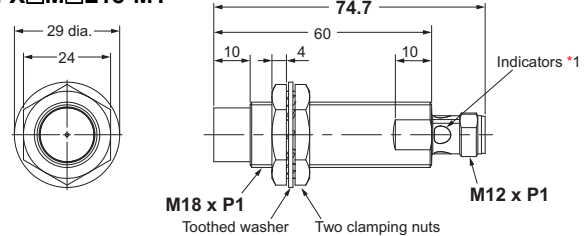

#### E2E-X18M□30-M1

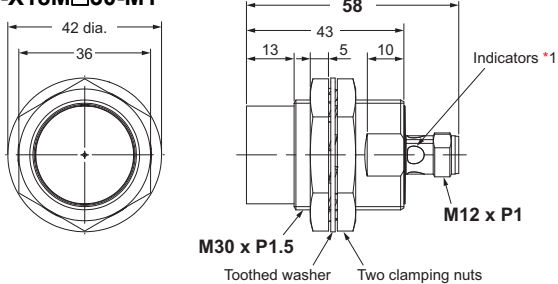

#### E2E-X18M□L30-M1

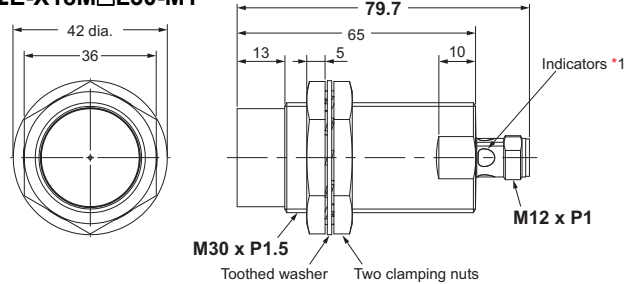

\*1. Standard I/O mode (SIO mode): Operation indicator (orange/ON), communication indicator (green/OFF)  
IO-Link Communication mode (COM mode): Operation indicator (orange/ON), communication indicator (green/Flashing (1sec cycle))

#### Mounting Hole Dimensions



Dimensions	F (mm)
M8	8.5 dia. $^{+0.5}_0$
M12	12.5 dia. $^{+0.5}_0$
M18	18.5 dia. $^{+0.5}_0$
M30	30.5 dia. $^{+0.5}_0$

#### E2E-X30M□L30-M1

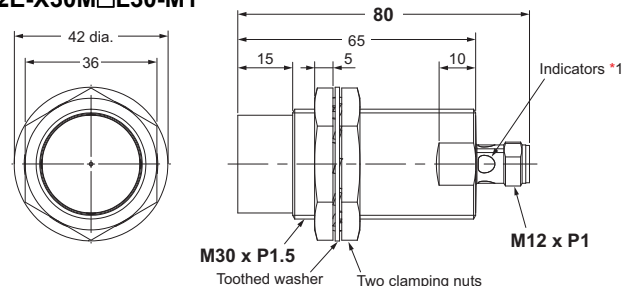

Accessories (Sold Separately)

e-jig (Mounting Sleeves)

Y92E-J8S12

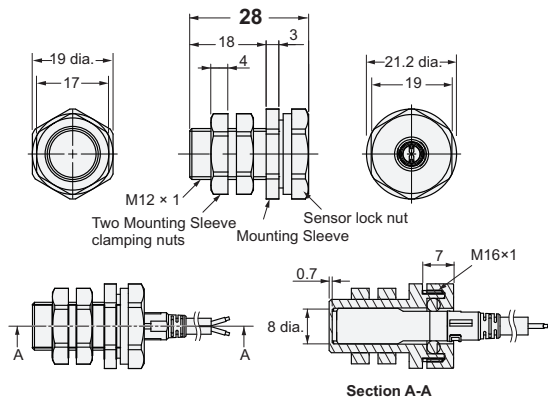

Y92E-J12S18

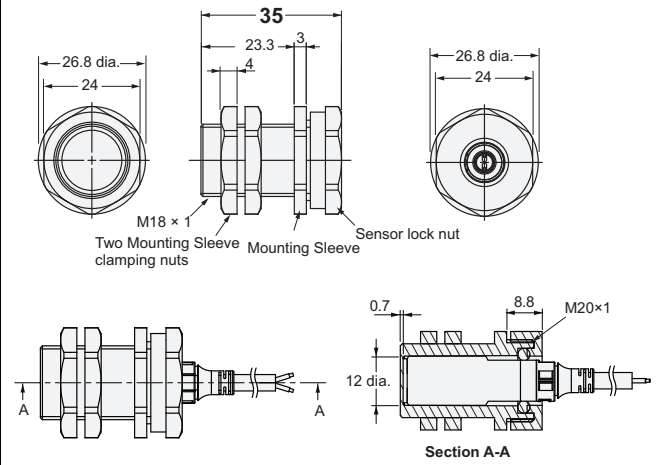

Y92E-J18S30

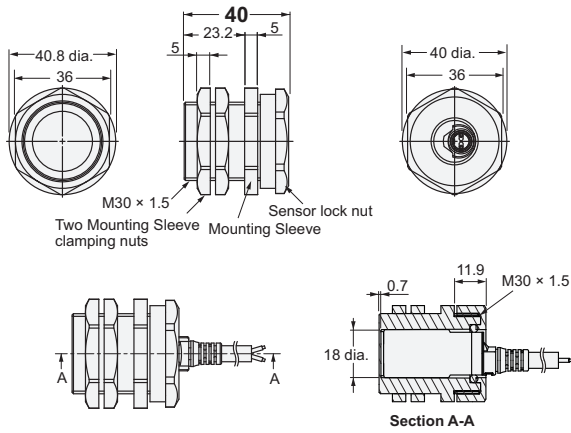

Material

Mounting Sleeve	Polyetheretherketone (PEEK) / Polybutylene terephthalate (PBT)
Mounting Sleeve clamping nut	Polybutylene terephthalate (PBT)
Sensor lock nut	Polybutylene terephthalate (PBT)
Sensor lock O-ring	Material combining HNBR and fluororubber

Tightening Force

Model	Torque	
	Mounting Sleeve clamping nut	Sensor lock nut
Y92E-J8S12	0.6 N·m	0.6 N·m
Y92E-J12S18	1.2 N·m	1.2 N·m
Y92E-J18S30	5 N·m	3.5 N·m

DC 2-wire Triple distance model

DC 2-wire Standard/Double/Single distance model

DC 3-wire

XS5 NEXT Series

XS5

XS3

# XS5 NEXT Series

## Round Oil-resistive Smartclick Connectors for E2E NEXT Series proximity sensors, that are Resistant to Oil, and that Reduce Installation Work



For the most recent information on models that have been certified for safety standards, refer to your OMRON website.

- Uses unique OMRON technology\*<sup>1</sup> and the same PVC cable with increased oil resistance as the E2E NEXT Series proximity sensors. Oil-resistance performance values of 2 years\*<sup>2</sup> when used in combination with E2E NEXT Series proximity sensors.
- Oil-resistant robot cables for use with moving parts such as loaders and cableveyors
- OMRON's unique lock mechanism (Smartclick) that is compatible with round M12 connectors.
- Simply insert the Connectors, then turn them approximately 1/8 of a turn to lock.
- A positive click indicates locking.
- IP67, IP69K degree of protection.
- UL approved products.

\*1. Patented (as of March, 2022)

\*2. Covered types of oil: Cutting oil specified in JIS K 2241:2000

The oil-resistance performance value (2 years) indicates the median value (=Typ) at product design, and in evaluation testing results of oil-resistance performance. Shipped products will show some variance around this 2 year value in actual usage.

**Note:** For details, refer to XS5 NEXT Series on your OMRON website.

## Ordering Information

### Sensor I/O Connectors

A Sensor I/O Connector is not provided with the Sensor. It must be ordered separately as required.

Appearance	Cable Specification	Type	Cable diameter (mm)	Cable Connection Direction	Cable length (m)	Sensor I/O Connector model number	Applicable Proximity Sensor model number
M12 Smartclick Connector Straight type 	Oil-resistant PVC cable	Sockets on One Cable End	6 dia.	Straight	1	XS5F-D421-C80-X	E2E-X□D□-M1(T)(G)J(R)(-T) E2E-X□D□-M1(G)(-T) E2E-X□□□-M1TJ(R) E2E-X□□□-M1
					2	XS5F-D421-D80-X	
					3	XS5F-D421-E80-X	
					5	XS5F-D421-G80-X	
					10	XS5F-D421-J80-X	
	Oil-resistant PVC robot cable	Sockets on One Cable End	6 dia.	Straight	1	XS5F-D421-C80-XR	
					2	XS5F-D421-D80-XR	
					3	XS5F-D421-E80-XR	
					5	XS5F-D421-G80-XR	
					10	XS5F-D421-J80-XR	
	Oil-resistant PVC cable	Socket and Plug on Cable Ends	6 dia.	Straight (Socket)/ Straight (Plug)	1	XS5W-D421-C81-X	
					2	XS5W-D421-D81-X	
					3	XS5W-D421-E81-X	
					5	XS5W-D421-G81-X	
					10	XS5W-D421-J81-X	
	Oil-resistant PVC robot cable	Socket and Plug on Cable Ends	6 dia.	Straight (Socket)/ Straight (Plug)	1	XS5W-D421-C81-XR	
					2	XS5W-D421-D81-XR	
					3	XS5W-D421-E81-XR	
					5	XS5W-D421-G81-XR	
					10	XS5W-D421-J81-XR	

# Connections for Sensor I/O Connectors

## DC 2-wire

Proximity Sensor				Sensor I/O Connector Model	Connections	
Type	Polarity	Operation mode	Model			
M12 Connector/ M12 Smartclick Connector	Yes	NO	E2E-X□D1□-M1(T)G(J)	XS5F-D421-□80-X□ XS5W-D421-□81-X□		
			E2E-X□D1□-M1(T)(J)			
		NC	E2E-X□D2□-M1(T)G(J)			
			E2E-X□D2□-M1(T)(J)			
		No	NO		E2E-X□D1-M1(T)G(J)-T (Standard/Double distance model)	
					E2E-X□D1-M1(T)(J)-T	
	E2E-X□D1-M1TGJ-T (Triple distance/Single distance model)					
	NC		E2E-X□D2-M1(T)G(J)-T (Standard/Double distance model)			
			E2E-X□D2-M1(T)(J)-T			
			E2E-X□D2-M1TGJ-T (Triple distance/Single distance model)			

**Note:** Different from Proximity Sensor wire colors.

\* If the XS5W Series Connector which has a socket and plug on the cable ends is connected to the Sensor, this part will be a plug.

Triple distance model  
DC 2-wire

Standard/Double/Single distance model  
DC 2-wire

DC 3-wire

XS5 NEXT Series

XS5

XS3

# XS5 NEXT Series

## DC 3-wire

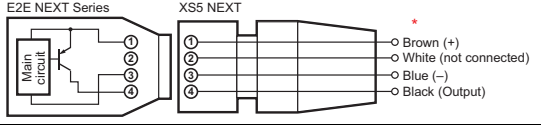
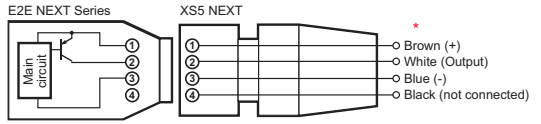
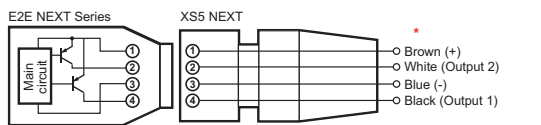
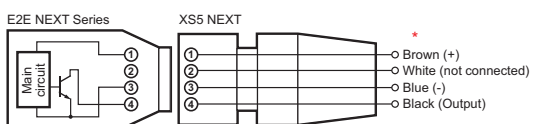
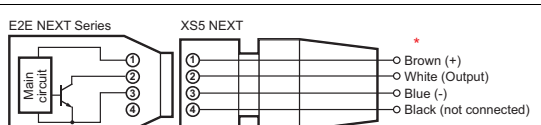
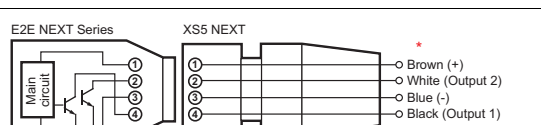
Proximity Sensor				Sensor I/O Connectors	
Types	Output	Operation mode	Model	Model	Connections *
M12 Connector/ M12 Smartclick Connector	PNP	NO	E2E-X□B1□-M1TJ/ M1	XS5F-D421-□80-X□ XS5W-D421-□81-X□	
		NC	E2E-X□B2□-M1TJ/M1		
		NO+NC	E2E-X□B3□-M1TJ/M1		
	NPN	NO	E2E-X□C1□-M1TJ/M1		
		NC	E2E-X□C2□-M1TJ/M1		
		NO+NC	E2E-X□C3□-M1TJ/M1		

**Note:** Different from Proximity Sensor wire colors.

\* If the XS5W Series Connector which has a socket and plug on the cable ends is connected to the Sensor, this part will be a plug.

## Sensor I/O Connectors Oil resistance performance of mating combination

E2E NEXT Series		Applicable connector Model
Connecting method	Model	XS5 NEXT Series
Pre-wired Connector Models	E2E-X□D□-M1T(G)J(R)	Oil resistant (2 years)*
	E2E-X□□-M1TJ(R)	
M12 Connector Models	E2E-X□D□-M1(G)	Water-resistant (IP67)
	E2E-X□□-M1	

\* Applicable cutting oil type: specified in JIS K 2241:2000

2 years of oil resistance indicates the median value of the product design and the oil-resistance performance criterion result (=Typical value). Products to be shipped will have around 2 years of oil resistance, but will vary depending on the product.

## Dimensions

(Unit: mm)

### Both end connector type XS5W

#### Wiring Diagram for 4 Cores

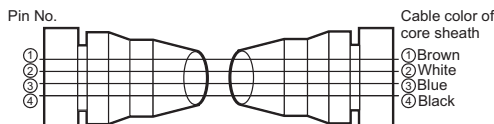

#### Straight (Socket)/Straight (Plug) XS5W-D421-□81-X/XS5W-D421-□81-XR

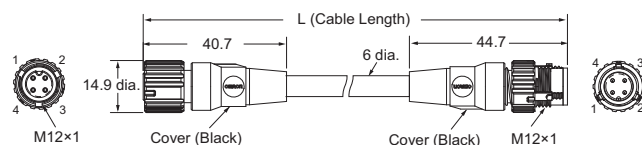

### One end connector type XS5F

#### Wiring Diagram for 4 Cores

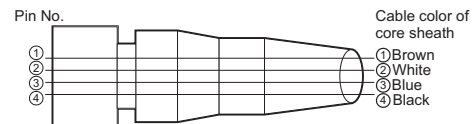

#### Straight XS5F-D421-□80-X/XS5F-D421-□80-XR

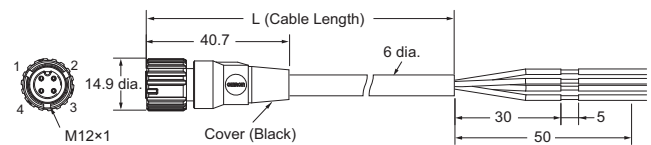

# Round Water-resistant Connectors (M12 Smartclick) XS5

## Round Water-resistive Smartclick Connectors for E2E NEXT Series proximity sensors that Reduce Installation Work

- A newly developed lock mechanism that is compatible with round M12 connectors.
- Simply insert the Connectors, then turn them approximately 1/8 of a turn to lock.
- A positive click indicates locking.
- IP67 degree of protection.
- UL approved products.

**Note:** For details, refer to XS5 on your OMRON website.





For the most recent information on models that have been certified for safety standards, refer to your OMRON website.

## Ordering Information

### Sensor I/O Connectors

A Sensor I/O Connector is not provided with the Sensor. It must be ordered separately as required.

Appearance	Cable Specification	Type	Cable diameter (mm)	Cable Connection Direction	Cable length (m)	Sensor I/O Connector model number	Applicable Proximity Sensor model number
M12 Smartclick Connector  Straight type    Right-angle type  	PVC robot cable	Sockets on One Cable End	6 dia.	Straight	1	XS5F-D421-C80-F	E2E-X□□□-M1(T)(G)J(R)(-T) E2E-X□□□-M1(G)(-T) E2E-X□□□-M1TJ(R) E2E-X□□□-M1
					2	XS5F-D421-D80-F	
					3	XS5F-D421-E80-F	
					5	XS5F-D421-G80-F	
					10	XS5F-D421-J80-F	
				Right-angle	1	XS5F-D422-C80-F	
					2	XS5F-D422-D80-F	
					3	XS5F-D422-E80-F	
					5	XS5F-D422-G80-F	
					10	XS5F-D422-J80-F	
		Socket and Plug on Cable Ends	6 dia.	Straight (Socket)/ Straight (Plug)	1	XS5W-D421-C81-F	
					2	XS5W-D421-D81-F	
					3	XS5W-D421-E81-F	
					5	XS5W-D421-G81-F	
Right-angle (Socket)/ Right-angle (Plug)	2			XS5W-D422-D81-F			
	5			XS5W-D422-G81-F			
Straight (Socket)/ Right-angle (Plug)	2			XS5W-D423-D81-F			
	5			XS5W-D423-G81-F			
Right-angle (Socket)/ Straight (Plug)	2	XS5W-D424-D81-F					
	5	XS5W-D424-G81-F					

Triple distance model

Standard/Double/Single distance model

DC 2-wire  
DC 3-wire

DC 2-wire

DC 3-wire

XS5 NEXT Series

XS5

XS3

# XS5

## Connections for Sensor I/O Connectors

### DC 2-wire

Proximity Sensor				Sensor I/O Connector model number	Connections	
Type	Polarity	Operation mode	Model			
M12 Connector/ M12 Smartclick Connector	Yes	NO	E2E-X□D1□-M1(T)G(J)	XS5F-D42□-□80-F XS5W-D42□-□81-F		
			E2E-X□D1□-M1(T)(J)			
		NC	E2E-X□D2□-M1(T)G(J)			
			E2E-X□D2□-M1(T)(J)			
		No	NO		E2E-X□D1-M1(T)G(J)-T (Standard/Double distance model)	
					E2E-X□D1-M1(T)(J)-T E2E-X□D1-M1TGJ-T (Triple distance/Single distance model)	
	NC		E2E-X□D2-M1(T)G(J)-T (Standard/Double distance model)			
			E2E-X□D2-M1(T)(J)-T E2E-X□D2-M1TGJ-T (Triple distance/Single distance model)			

**Note:** Different from Proximity Sensor wire colors.

\* If the XS5W Series Connector which has a socket and plug on the cable ends is connected to the Sensor, this part will be a plug.



DC 3-wire

Proximity Sensor				Sensor I/O Connectors	
Types	Output	Operation mode	Model	Model	Connections
M12 Connector/ M12 Smartclick Connector	PNP	NO	E2E-X□B1□- M1TJ/ M1	XS5F-D421-□80-X□ XS5W-D421-□81-X□	
		NC	E2E-X□B2□-M1TJ/M1		
		NO+NC	E2E-X□B3□-M1TJ/M1		
	NPN	NO	E2E-X□C1□-M1TJ/M1		
		NC	E2E-X□C2□-M1TJ/M1		
		NO+NC	E2E-X□C3□-M1TJ/M1		

**Note:** Different from Proximity Sensor wire colors.

\* If the XS5W Series Connector which has a socket and plug on the cable ends is connected to the Sensor, this part will be a plug.

Sensor I/O Connectors Oil resistance performance of mating combination

E2E NEXT Series		Applicable connector Model
Connecting method	Model	XS5 Series
Pre-wired Connector Models	E2E-X□D□-M1T(G)J(R)	Water-resistant (IP67)
	E2E-X□□-M1TJ(R)	
M12 Connector Models	E2E-X□D□-M1(G)	
	E2E-X□□-M1	

Triple distance model  
DC 2-wire

Standard/Double/Single distance model  
DC 2-wire

DC 3-wire

XS5 NEXT Series

XS5

XS3

# XS5

## Dimensions

(Unit: mm)

### Socket and Plug on Cable Ends XS5W

#### Wiring Diagram for 4 Cores

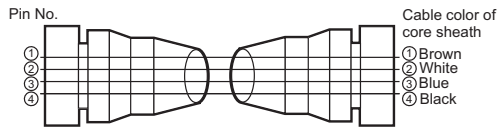

### Sockets on One Cable End XS5F

#### Wiring Diagram for 4 Cores

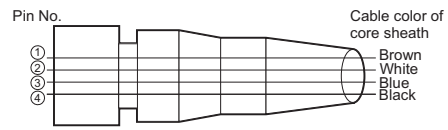

### Straight (Socket)/Straight (Plug) XS5W-D421-□81-F

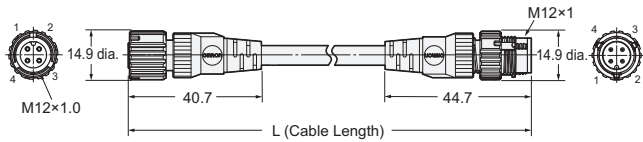

### Straight XS5F-D421-□80-F

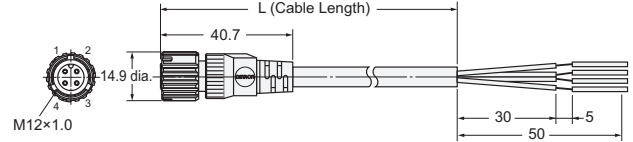

### Right-angle (Socket)/right-angle (Plug) XS5W-D422-□81-F

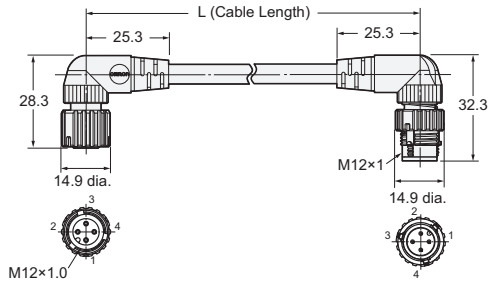

### Right-angle XS5F-D422-□80-F

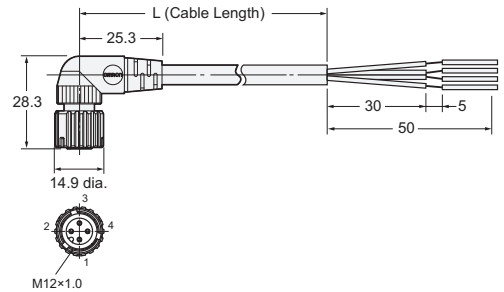

### Straight (Socket)/right-angle (Plug) XS5W-D423-□81-F

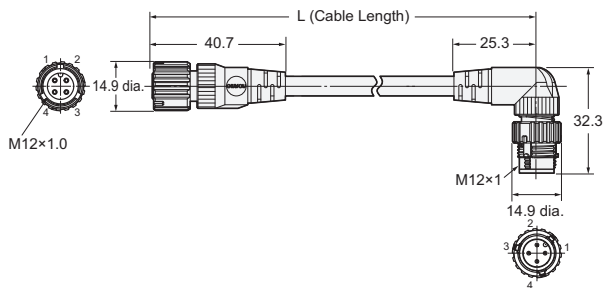

### Right-angle (Socket)/Straight (Plug) XS5W-D424-□81-F

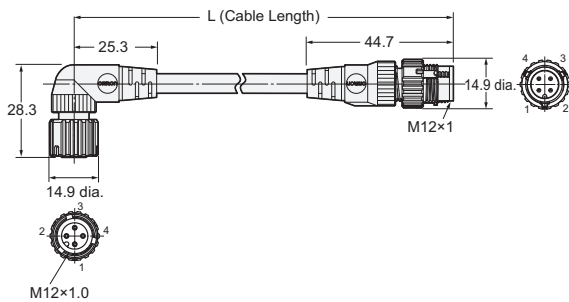

## Small Round Water-resistive Connectors

- Water-resistive, compact connector meets IP67 requirements.
- XS3-R Series; connectors with cables are available. M8 models are UL certified.
- Oil-resistant Polyurethane Robot Cables added.

**Note:** For details, refer to XS3 on your OMRON website.





For the most recent information on models that have been certified for safety standards, refer to your OMRON website.

## Ordering Information

### Sensor I/O Connectors

A Sensor I/O Connector is not provided with the Sensor. It must be ordered separately as required.

Appearance	Cable specification	Type	Cable diameter (mm)	No. of cable cores (Poles)	Cable connection direction	Cable length (m)	Sensor I/O Connector model number	Applicable Proximity Sensor model number
M8 Connector Straight type  Right-angle type 	PVC robot cable	Sockets on One Cable End	4 dia.	3	Straight	2	XS3F-M321-302-R	E2E-X□□□-M5
						5	XS3F-M321-305-R	
						10	XS3F-M321-310-R	
					Right-angle	2	XS3F-M322-302-R	
						5	XS3F-M322-305-R	
						10	XS3F-M322-310-R	
		Socket and Plug on Cable Ends	4 dia.	4	Straight	2	XS3F-M421-402-R	E2E-X□□□-M3
						5	XS3F-M421-405-R	
						10	XS3F-M421-410-R	
					Right-angle	2	XS3F-M422-402-R	
						5	XS3F-M422-405-R	
						10	XS3F-M422-410-R	
Socket and Plug on Cable Ends	4 dia.	3	Straight (Plug)/ Straight (Socket)	2	XS3W-M321-302-R	E2E-X□□□-M5		
				5	XS3W-M321-305-R			
				10	XS3W-M321-310-R			
			Straight (Plug)/ Straight (Socket)	2	XS3W-M421-402-R	E2E-X□□□-M3		
				5	XS3W-M421-405-R			
				10	XS3W-M421-410-R			

DC 2-wire  
Triple distance model

DC 2-wire  
Standard/Double/Single distance model

DC 3-wire

XS5 NEXT Series

XS5

XS3

# XS3

## Connections for Sensor I/O Connectors

### DC 2-wire

Proximity Sensor				Sensor I/O Connector model number	Connections
Type	Polarity	Operation mode	Model		
M8 (4-pin) Connector Models	Yes	NO	E2E-X□D1-M3G	XS3W-M42□-4□-R XS3F-M42□-4□-R	<ul style="list-style-type: none"> <li>○ Brown (+)</li> <li>○ White (not connected)</li> <li>○ Blue (not connected)</li> <li>○ Black (-)</li> </ul>
		NC	E2E-X□D2-M3G		<ul style="list-style-type: none"> <li>○ Brown (+)</li> <li>○ White (-)</li> <li>○ Blue (not connected)</li> <li>○ Black (not connected)</li> </ul>

### DC 3-wire

Proximity Sensor				Sensor I/O Connectors	
Types	Output	Operation mode	Model	Model	Connections
M8 (4-pin) Connector Models	PNP	NO	E2E-X□B1□-M3	XS3W-M42□-4□-R XS3F-M42□-4□-R	<ul style="list-style-type: none"> <li>○ Brown (+)</li> <li>○ White (not connected)</li> <li>○ Blue (-)</li> <li>○ Black (Output)</li> </ul>
		NC	E2E-X□B2□-M3		<ul style="list-style-type: none"> <li>○ Brown (+)</li> <li>○ White (Output)</li> <li>○ Blue (-)</li> <li>○ Black (not connected)</li> </ul>
	NPN	NO	E2E-X□C1□-M3		<ul style="list-style-type: none"> <li>○ Brown (+)</li> <li>○ White (not connected)</li> <li>○ Blue (-)</li> <li>○ Black (Output)</li> </ul>
		NC	E2E-X□C2□-M3		<ul style="list-style-type: none"> <li>○ Brown (+)</li> <li>○ White (Output)</li> <li>○ Blue (-)</li> <li>○ Black (not connected)</li> </ul>
M8 (3-pin) Connector Models	PNP	NO	E2E-X□B1□-M5	XS3W-M32□-3□-R XS3F-M32□-3□-R	<ul style="list-style-type: none"> <li>○ Brown (+)</li> <li>○ Black (Output)</li> <li>○ Blue (-)</li> </ul>
		NC	E2E-X□B2□-M5		<ul style="list-style-type: none"> <li>○ Brown (+)</li> <li>○ White (Output)</li> <li>○ Blue (-)</li> <li>○ Black (not connected)</li> </ul>
	NPN	NO	E2E-X□C1□-M5		<ul style="list-style-type: none"> <li>○ Brown (+)</li> <li>○ Black (Output)</li> <li>○ Blue (-)</li> </ul>
		NC	E2E-X□C2□-M5		<ul style="list-style-type: none"> <li>○ Brown (+)</li> <li>○ Black (Output)</li> <li>○ Blue (-)</li> </ul>

**Note:** Different from Proximity Sensor wire colors.

\* If the XS3W Series Connector which has a socket and plug on the cable ends is connected to the Sensor, this part will be a plug.

### Sensor I/O Connectors Oil resistance performance of mating combination

E2E NEXT Series		Applicable connector Model
Connecting method	Model	XS3 Series
M8 (4-pin) Connector Models	E2E-X□D□-M3G	Water-resistant (IP67)
	E2E-X□□-M3	
M8 (3-pin) Connector Models	E2E-X□□-M5	

Dimensions

Socket and Plug on Cable Ends XS3W

Wiring Diagram for 3 Cores

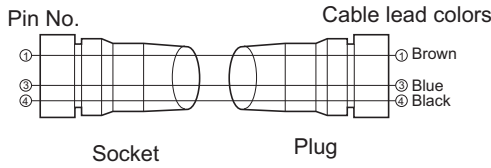

Straight (Socket)/Straight (Plug)  
XS3W-M321-3□□-R

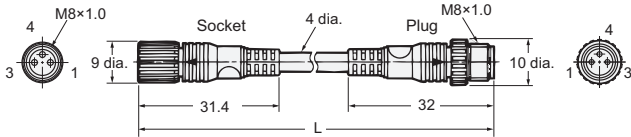

Sockets on One Cable End XS3F

Wiring Diagram for 3 Cores

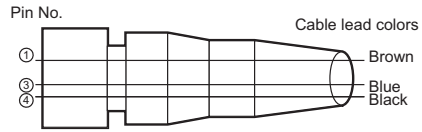

Straight  
XS3F-M321-3□□-R

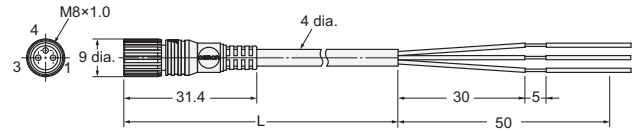

Right-angle  
XS3F-M322-3□□-R

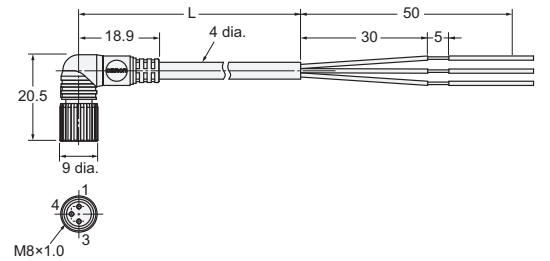

Socket and Plug on Cable Ends XS3W

Wiring Diagram for 4 Cores

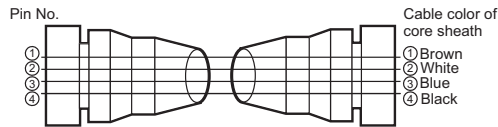

Straight (Socket)/Straight (Plug)  
XS3W-M421-4□□-R

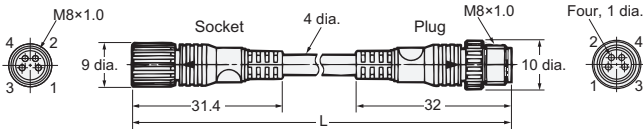

Sockets on One Cable End XS3F

Wiring Diagram for 4 Cores

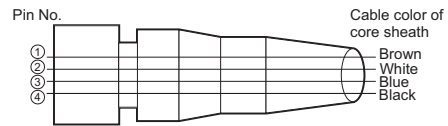

Straight  
XS3F-M421-4□□-R

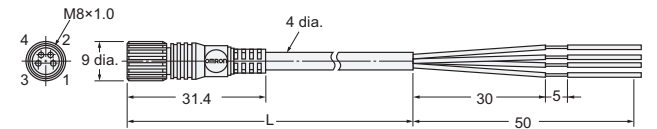

Right-angle  
XS3F-M422-4□□-R

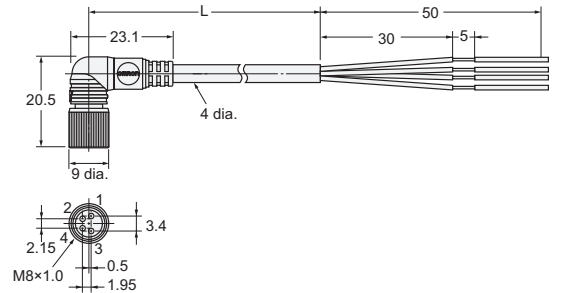

DC 2-wire  
Triple distance model

DC 2-wire  
Standard/Double/Single distance model

DC 3-wire

XS5 NEXT Series

XS5

XS3



# Terms and Conditions Agreement

## **Read and understand this catalog.**

Please read and understand this catalog before purchasing the products. Please consult your OMRON representative if you have any questions or comments.

## **Warranties.**

(a) Exclusive Warranty. Omron's exclusive warranty is that the Products will be free from defects in materials and workmanship for a period of twelve months from the date of sale by Omron (or such other period expressed in writing by Omron). Omron disclaims all other warranties, express or implied.

(b) Limitations. OMRON MAKES NO WARRANTY OR REPRESENTATION, EXPRESS OR IMPLIED, ABOUT NON-INFRINGEMENT, MERCHANTABILITY OR FITNESS FOR A PARTICULAR PURPOSE OF THE PRODUCTS. BUYER ACKNOWLEDGES THAT IT ALONE HAS DETERMINED THAT THE PRODUCTS WILL SUITABLY MEET THE REQUIREMENTS OF THEIR INTENDED USE.

Omron further disclaims all warranties and responsibility of any type for claims or expenses based on infringement by the Products or otherwise of any intellectual property right. (c) Buyer Remedy. Omron's sole obligation hereunder shall be, at Omron's election, to (i) replace (in the form originally shipped with Buyer responsible for labor charges for removal or replacement thereof) the non-complying Product, (ii) repair the non-complying Product, or (iii) repay or credit Buyer an amount equal to the purchase price of the non-complying Product; provided that in no event shall Omron be responsible for warranty, repair, indemnity or any other claims or expenses regarding the Products unless Omron's analysis confirms that the Products were properly handled, stored, installed and maintained and not subject to contamination, abuse, misuse or inappropriate modification. Return of any Products by Buyer must be approved in writing by Omron before shipment. Omron Companies shall not be liable for the suitability or unsuitability or the results from the use of Products in combination with any electrical or electronic components, circuits, system assemblies or any other materials or substances or environments. Any advice, recommendations or information given orally or in writing, are not to be construed as an amendment or addition to the above warranty.

See <http://www.omron.com/global/> or contact your Omron representative for published information.

## **Limitation on Liability; Etc.**

OMRON COMPANIES SHALL NOT BE LIABLE FOR SPECIAL, INDIRECT, INCIDENTAL, OR CONSEQUENTIAL DAMAGES, LOSS OF PROFITS OR PRODUCTION OR COMMERCIAL LOSS IN ANY WAY CONNECTED WITH THE PRODUCTS, WHETHER SUCH CLAIM IS BASED IN CONTRACT, WARRANTY, NEGLIGENCE OR STRICT LIABILITY.

Further, in no event shall liability of Omron Companies exceed the individual price of the Product on which liability is asserted.

## **Suitability of Use.**

Omron Companies shall not be responsible for conformity with any standards, codes or regulations which apply to the combination of the Product in the Buyer's application or use of the Product. At Buyer's request, Omron will provide applicable third party certification documents identifying ratings and limitations of use which apply to the Product. This information by itself is not sufficient for a complete determination of the suitability of the Product in combination with the end product, machine, system, or other application or use. Buyer shall be solely responsible for determining appropriateness of the particular Product with respect to Buyer's application, product or system. Buyer shall take application responsibility in all cases.

NEVER USE THE PRODUCT FOR AN APPLICATION INVOLVING SERIOUS RISK TO LIFE OR PROPERTY OR IN LARGE QUANTITIES WITHOUT ENSURING THAT THE SYSTEM AS A WHOLE HAS BEEN DESIGNED TO ADDRESS THE RISKS, AND THAT THE OMRON PRODUCT(S) IS PROPERLY RATED AND INSTALLED FOR THE INTENDED USE WITHIN THE OVERALL EQUIPMENT OR SYSTEM.

## **Programmable Products.**

Omron Companies shall not be responsible for the user's programming of a programmable Product, or any consequence thereof.

## **Performance Data.**

Data presented in Omron Company websites, catalogs and other materials is provided as a guide for the user in determining suitability and does not constitute a warranty. It may represent the result of Omron's test conditions, and the user must correlate it to actual application requirements. Actual performance is subject to the Omron's Warranty and Limitations of Liability.

## **Change in Specifications.**

Product specifications and accessories may be changed at any time based on improvements and other reasons. It is our practice to change part numbers when published ratings or features are changed, or when significant construction changes are made. However, some specifications of the Product may be changed without any notice. When in doubt, special part numbers may be assigned to fix or establish key specifications for your application. Please consult with your Omron's representative at any time to confirm actual specifications of purchased Product.

## **Errors and Omissions.**

Information presented by Omron Companies has been checked and is believed to be accurate; however, no responsibility is assumed for clerical, typographical or proofreading errors or omissions.

## Related Products



Welding Proximity Sensors  
E2EW Series/E2EQ NEXT Series

Cat. No. D125

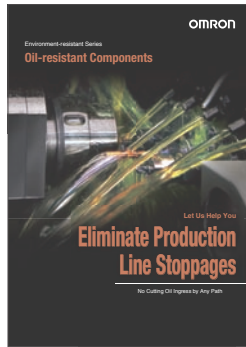

Environment-resistant Series  
Oil-resistant Components

Cat. No. Y215



IO-Link Series

Cat. No. Y229

**Smartclick** is a registered trademark of OMRON Corporation.

Company names and product names in this document are the trademarks or registered trademarks of their respective companies. The product photographs and figures that are used in this catalog may vary somewhat from the actual products.

**Note: Do not use this document to operate the Unit.**

### OMRON Corporation Industrial Automation Company

Kyoto, JAPAN

Contact : [www.ia.omron.com](http://www.ia.omron.com)

#### Regional Headquarters

##### OMRON EUROPE B.V.

Wegalaan 67-69, 2132 JD Hoofddorp  
The Netherlands  
Tel: (31) 2356-81-300 Fax: (31) 2356-81-388

##### OMRON ELECTRONICS LLC

2895 Greenspoint Parkway, Suite 200  
Hoffman Estates, IL 60169 U.S.A.  
Tel: (1) 847-843-7900 Fax: (1) 847-843-7787

##### OMRON ASIA PACIFIC PTE. LTD.

438B Alexandra Road, #08-01/02 Alexandra  
Technopark, Singapore 119968  
Tel: (65) 6835-3011 Fax: (65) 6835-3011

##### OMRON (CHINA) CO., LTD.

Room 2211, Bank of China Tower,  
200 Yin Cheng Zhong Road,  
PuDong New Area, Shanghai, 200120, China  
Tel: (86) 21-6023-0333 Fax: (86) 21-5037-2388

Authorized Distributor:

©OMRON Corporation 2022-2024 All Rights Reserved.  
In the interest of product improvement,  
specifications are subject to change without notice.

**CSM\_6\_4**

Cat. No. D120-E1-13 0524 (0922)