

Product Data Sheet

GW10051AB

CHORUSMART - Domestic range

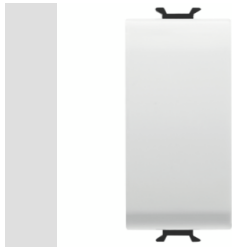

A range of ChoruSmart modular devices and plates made of antibacterial technopolymer in a glossy white finish, suitable for use in hospitals, nursing homes, schools and wherever cleanness and hygiene are essential. The effective silver-ion antibacterial treatment can reduce bacterial growth by 99% within 24 hours and has been verified by certified laboratory testing in accordance with standard ISO 22196 (analysis of major strains of Staphylococcus aureus and E. coli bacterial species).

Category	Switch	Button key	Neutral
Colour	Glossy white	Description	1P - 16AX
Voltage	250 V ac	Standard	EN 60669-1; ISO 22196
Resistance at test voltage	2000 V at 50 Hz for 1 minute	Rated power of 230V LED lamps	200 W
Insulation resistance	> 5 MOhm	Wiring terminals	With screw
Prolonged operation switch (no.of position changes)	40.000 at In 250 V ac cosφ=0,6	Thermo-pressure with ball	125 °C
Glow Wire Test	850 °C	Terminal grip on cable traction	> 50 N
Terminal tightening capacity stranded cables (mm ²)	min. 0,75 - max. 2x4	Terminal tightening capacity solid cables (mm ²)	min. 0,5 - max. 2x2,5
No. modules	1	Material	Antibacterial tecnopolymer
Electrocod	0130		

DIMENSIONAL

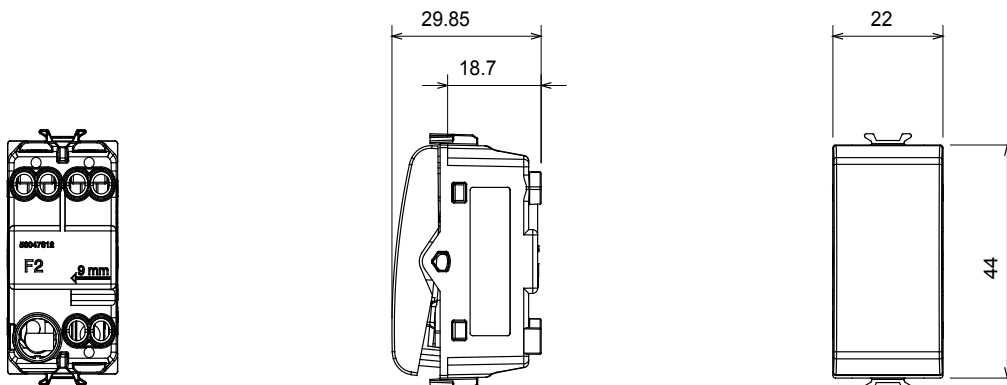

TECHNICAL SYMBOLOGY



STANDARDS/APPROVALS

