

Product Data Sheet

GW95859

90 RCD Range



| | |
|---|----------------------------------|
| Description | RCCB WITH OVERCURRENT PROTECTION |
| Code | MDC 60 |
| No. of poles | 4P |
| No. modules | 4 |
| Rated current | 25 A |
| Rated residual operating current | 300 mA |
| Type | A[S] |
| Curve | C |
| Rated voltage (IEC/EN 61009-1, 61009-2-1) | 400/415 V |

| | | | |
|--|---|---|---|
| Energy limiting class | 1 | Standard | IEC/EN 61009-1, IEC/EN 61009-2-1 |
| Rated frequency (Hz) | 50/60 Hz | Breaking capacity IEC/EN 61009-1 400V (Icn) | 6000 A |
| Breaking capacity IEC/EN 61009-1 (Ics) | 1 x Icn | Breaking capacity IEC/EN 60947-2 400V (Icu) | 6 kA |
| Breaking capacity IEC/EN 60947-2 (Ics) | 100% Icu | Insulation voltage | 500 V |
| Level of immunity (8/20 μs) | 3000 A | Rated impulse withstand voltage | 4 kV |
| Overvoltage category | III | Electrical endurance | 10.000 |
| Mechanical endurance | 20.000 | Section rigid cable | <=1x35 - <=2x16 - <=1x16+2x10 mm ² |
| Section flexible cable | <=1x35 - <=2x16 - <=1x16+2x10 mm ² | Double connection | YES (only down stream) |
| Rated tightening torque | 2 Nm | Operating temperature | -25 +60° C (derating of In with T>30° C) |
| Stocking temperature | -40 +70 °C | Auxiliaries compatibility | Yes |
| ReStart compatibility | Yes | Assembly position | Any |

DIMENSIONAL

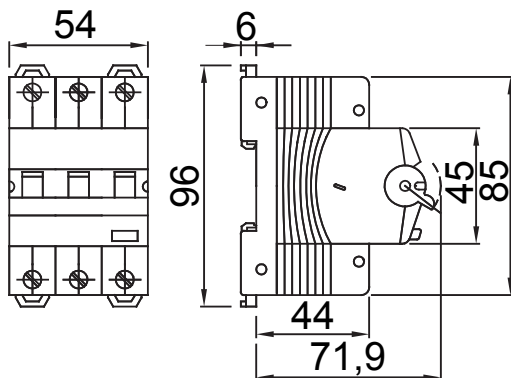

WIRING DIAGRAM

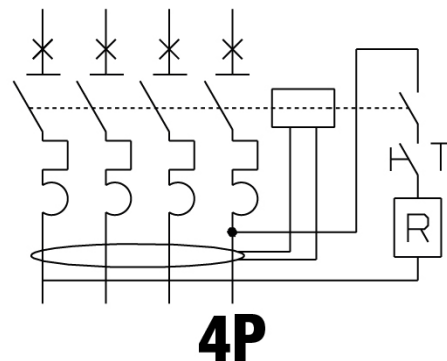

STANDARDS/APPROVALS

