

Product Data Sheet

GWF1100NC830

ELIA FL



ELIA FL is an LED floodlight, available in medium and high-power versions for outdoor and indoor applications in industrial, tertiary and sports contexts, such as façades, warehouses, car parks and sports fields. Available in 4 different sizes and power steps (50 W, 100 W, 150 W and 200 W), the range allows for great flexibility with its multiple possible combinations: 3 colour temperature options (3,000 K warm white, 4,000 K neutral white and 5,700 K cool white) with a colour rendering index of more than 80; 2 integrated power supply options (On/Off and DALI); and 2 optics options (60° and asymmetrical). The luminaire can be ceiling, wall or floor-mounted through the integrated adjustable steel bracket with a protractor, or pole-mounted (in poles with diameter up to 61 mm) through a dedicated accessory (to be ordered separately). Thanks to its black powder-coated die-cast aluminium body and its front glass, the fixture is tough, durable (IP66 and IK08) and is able to withstand harsh environmental conditions (such as ambient temperature variations from -30°C to +50°C).

GENERAL INFORMATION		OPTIC AND ILLUMINATING FEATURES	
Context	Industry, logistics, facades, sporting facilities and outdoor area lighting	Optic	Asymmetrical
Luminaire	LED luminaire with mid and high lumen power	Unified Glare Rating	ULOR = 0%
Application	Indoor / Outdoor	Lumen output (lm)	12900
Unique digital code (Datamatrix)	Currently not present	Efficacy (lm/W)	129
Colour	Black	Colour temperature	3000 K
Type of light source	LED	Colour Rendering Index	CRI 80
System power	100 W	Standard Deviation Colour Matching	SDCM = 5
LED Lifetime	L80B50 (Tq=25°C) = 80.000 h	Photobiological Risk Class	RG1
Weight (kg)	2.6	Standard	EN 60598-1; EN 60598-2-5; IEC/TR 62778; EN 62493
Warranty	5 years	ELECTRICAL AND LIGHTING FEATURES	
Stocking temperature	-40° +80°	Supply voltage	220-240 V
Operating temperature	-30°C ÷ +50 °C	Rated frequency (Hz)	50/60 Hz
MATERIALS		Driver	Built-in
Body	Die-cast aluminium	Driver failure rate	F10 (Tq=25°C) > 80.000 h
Shield type	Tempered 4mm-thick surface glass with Gewiss logo	Overvoltage protection	DM 4 kV/ CM 4 kV
Optic	High-efficiency lens and reflector unit	Control System	ON / OFF
Gasket	-	INSTALLATION AND MAINTENANCE	
Locking Hook	-	Mounting and installation	Floodlight mast - Ceiling - Wall - Ground
External screw	Stainless steel	Tilt	Rotation on bracket with integrated goniometer
Colour	Powder coating	Wiring	With power cable
STANDARDS AND APPROVALS		Fixing	Via integrated bracket
Classification	-	Light source replaceability	Non-replaceable
Device with reduced surface temperature	-	Controlgear replaceability	By professional
DIN 18032-3 certification	-	Driver Box	Built-in
IPEA	-	Maximum surface exposed to the wind	0,055 m2
Insulation class	I		Built-in
IP degree	IP66		Built-in
Mechanical resistance	IK08		Built-in
Glow Wire Test	750 °C		Built-in

DIMENSIONAL

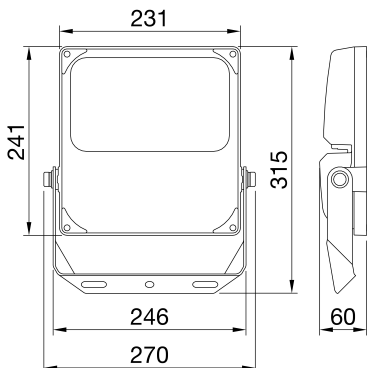

PHOTOMETRIC DISTRIBUTION

TECHNICAL SYMBOLOGY



0,055 m2



IP
IP66

IK
IK08

GWT
750 °C

Product Data Sheet
GWF1100NC830

ELIA FL

STANDARDS/APPROVALS

