

PHILIPS

Ledinaire SlimDownlight

DN065B

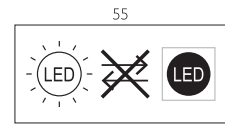
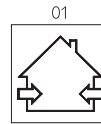
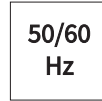
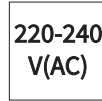
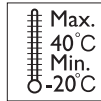
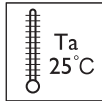
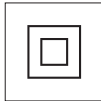
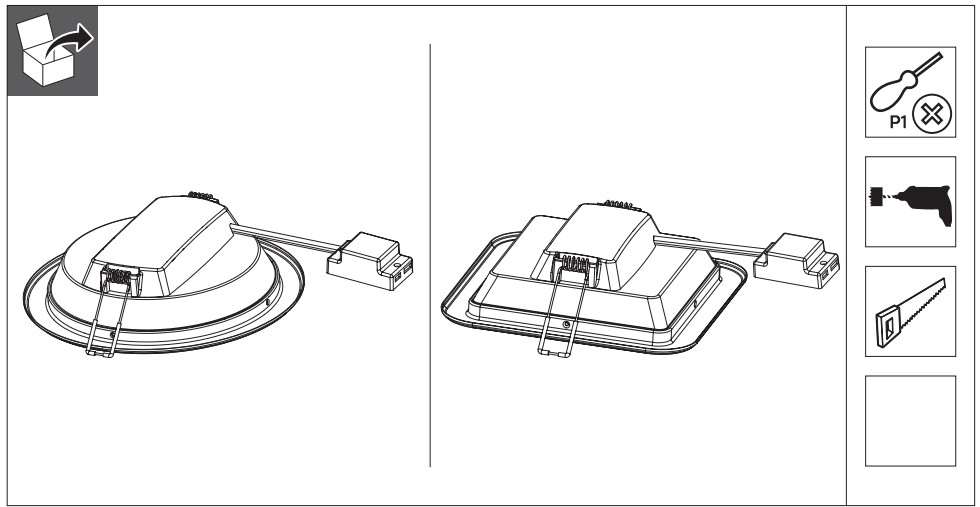

Model	Product Description	Power(W)	CRI(Ra)	CCT(K)	Total Lumen(lm)	Energy efficiency class of light source	Dimension AxB,C(mm)	Cut-Out D(mm)	Weight (kg)
9290032505	DN065B G4 LED12/830 12W 220-240V D150 RD	12	80	3000	1200	F	φ175*45,41	φ150	0.21
9290032506	DN065B G4 LED12/840 12W 220-240V D150 RD	12	80	4000	1200	F	φ175*45,41	φ150	0.21
9290032508	DN065B G4 LED20/830 19W 220-240V D200 RD	19	80	3000	2000	F	φ225*45,41	φ200	0.365
9290032509	DN065B G4 LED20/840 19W 220-240V D200 RD	19	80	4000	2000	F	φ225*45,41	φ200	0.365
9290032511	DN065B G4 LED12/830 12W 220-240V L150 SQ	12	80	3000	1200	F	L175*45,41	L150	0.21
9290032512	DN065B G4 LED12/840 12W 220-240V L150 SQ	12	80	4000	1200	F	L175*45,41	L150	0.21

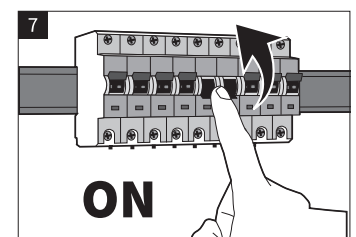
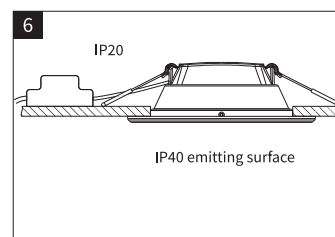
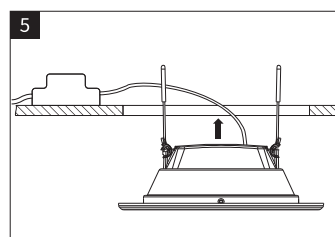
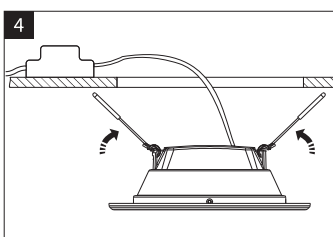
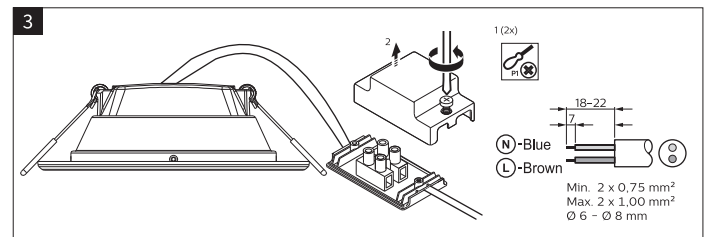
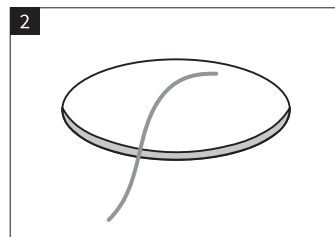
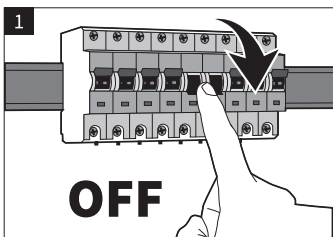
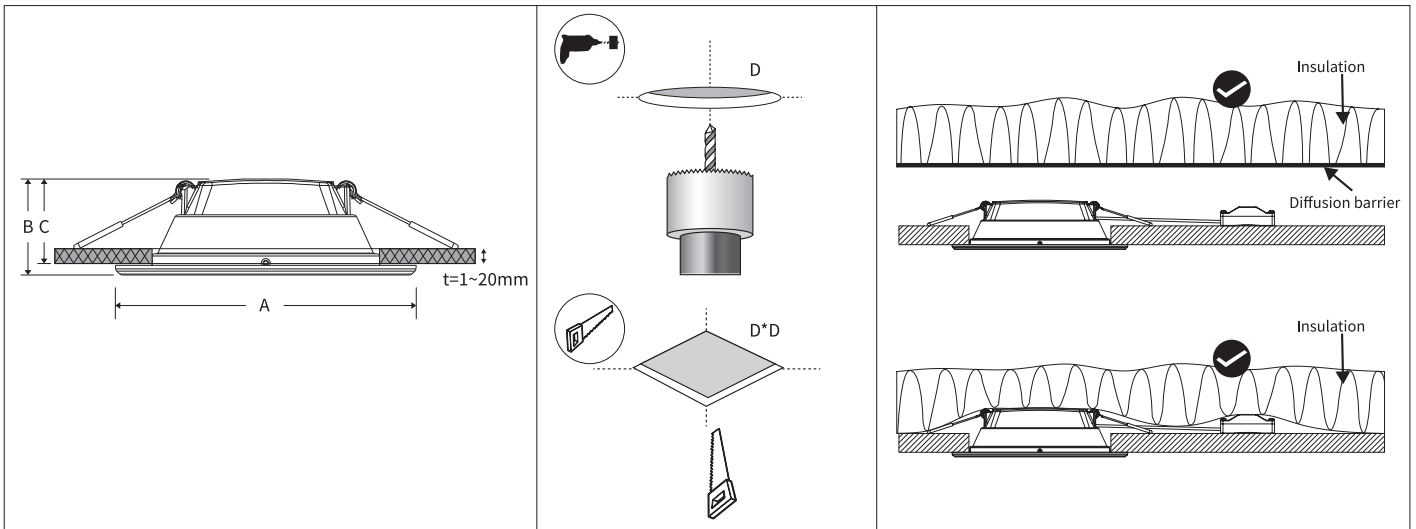

Inrush Current

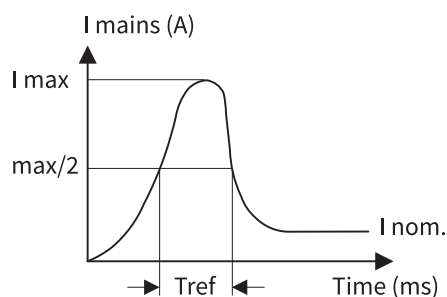

	9290032505 9290032506	9290032508 9290032509	9290032511 9290032512
Electrical characteristic			
I _{max} (A)	3.85	4.92	3.85
T _{ref} (μs)	0.101	0.115	0.101
MCB	Luminaire Max. (pcs)		
Type B-10A	46	34	46
Type B-16A	74	55	74
Type C-10A	78	59	78
Type C-16A	125	95	125



ATTENTION
OBSERVE PRECAUTIONS
FOR HANDLING
ELECTROSTATIC
SENSITIVE
DEVICES

- 01 Please read this manual before you start to install the luminaire.
- 02 The luminaire shall be installed by a qualified electrician and wired in accordance with the latest IEE electrical regulations of the national requirements.
- 03 Switch OFF the power supply before the installation or maintenance to avoid electrical shock.
- 04 The luminaire must not be used or stored in corrosive environment where hazardous materials such as Sulphur, Chlorine, Phthalates, etc., are present.

ATTENTION: Below you will find all the explanations with numeric reference to the icons respectively in front of these safety instructions:

- | | |
|--|---|
| <p>EN 01) The product should only be installed indoors.
17) The product is only suitable for wiring directly to the electrical mains supply.
30) The product is not dimmable.
55) Non-replaceable light source: The light source of this luminaire is not replaceable; when the light source reaches its end of life the whole luminaire shall be replaced.</p> | <p>ES 01) El producto debe instalarse únicamente en interiores.
17) El producto solo es apto para conectarse directamente a la red eléctrica.
30) El producto no se puede regular.
55) Fuente de luz no sustituible: La fuente de luz de este sistema de iluminación no se puede sustituir. Cuando la fuente de luz llegue al final de su vida útil, deberá sustituirse el sistema completo.</p> |
| <p>DE 01) Das Produkt sollte ausschließlich in geschlossenen Räumen installiert werden.
17) Das Produkt ist ausschließlich für die direkte Verdrahtung mit der elektrischen Stromversorgung geeignet.
30) Das Produkt ist nicht dimmbar.
55) Nicht austauschbare Lichtquelle: Die Lichtquelle in dieser Leuchte ist nicht austauschbar. Wenn die Lichtquelle das Ende ihrer Lebensdauer erreicht hat, muss die gesamte Leuchte ausgetauscht werden.</p> | <p>IT 01) Il prodotto può essere installato solo all'interno.
17) Il prodotto è adatto solo per l'allacciamento diretto alla rete elettrica.
30) Il prodotto non è dimmerabile.
55) Sorgente luminosa non sostituibile: La sorgente di luce di questo sistema di illuminazione non è sostituibile; quando la sorgente di luce giunge al termine del suo ciclo di vita, viene sostituito l'intero sistema di illuminazione.</p> |
| <p>FR 01) Le produit doit uniquement être installé en intérieur.
17) Le produit peut uniquement être branché directement sur le secteur.
30) L'intensité lumineuse du produit n'est pas variable.
55) Source lumineuse non remplaçable: La source lumineuse de ce luminaire n'est pas remplaçable. Lorsque la source lumineuse arrive en fin de vie, tout le luminaire doit être remplacé.</p> | <p>PL 01) produkt przeznaczony do montażu wyłącznie wewnątrz pomieszczeń.
17) produkt nadaje się wyłącznie do bezpośredniego podłączenia do źródła zasilania.
30) produkt nie ma funkcji przyciemniania.
55) Niewymienne źródło światła: źródła światła zamontowanego w tej oprawie nie można wymienić; gdy zakończy się</p> |



3241 659 85691

© 2022 Signify Holding
©ignify

Philips and the Philips Shield Emblem are registered trademarks of Koninklijke Philips N.V. and are used under license